

Mullard

Book 1 Part 9

Optoelectronic devices

May 1981

---

# Mullard technical handbook

---

---

## Book one

Semiconductor devices

---

## Part nine

Optoelectronic devices

---

---

May 1981

---



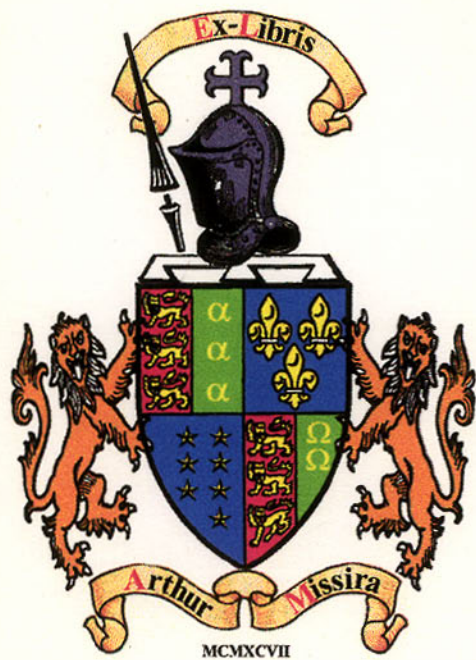

MCMXCVII

# OPTOELECTRONIC DEVICES

## CONTENTS

**GENERAL SAFETY RECOMMENDATIONS**

**GENERAL**

**A**

**PHOTODIODES AND PHOTOTRANSISTORS**

**B**

**LIGHT EMITTING DIODES**

**C**

**INFRARED DETECTORS**

**D**

**CUSTOM BUILT TGS PYROELECTRIC  
INFRARED DETECTORS**

**E**

**CUSTOM BUILT CMT INFRARED  
DETECTORS**

**F**

**CADMIUM SULPHIDE PHOTOCONDUCTIVE  
CELLS**

**G**

**PHOTOCOUPERS**

**H**

**LIQUID CRYSTAL DISPLAYS**

**J**

**INDEX**



The issue of the information contained in this publication does not imply any authority or licence for the utilisation of any patented feature.

'Mullard' is the trademark of Mullard Limited and is registered in most of the principal countries of the world.

© Mullard Limited 1981

**Book 1 comprises the following parts—**

- |         |   |
|---------|---|
| Part 1A | Small-signal transistors                          |
| Part 1B | Low-frequency power transistors                   |
| Part 1C | Field-effect transistors                          |
| Part 1D | Microminiature semiconductors for hybrid circuits |
| Part 2A | R.F. wideband devices                             |
| Part 2B | R.F. power devices                                |
| Part 3  | Diodes  |
| Part 4  | Power diodes, thyristors, triacs                  |
| Part 5  | Discontinued (combined with Part 4)               |
| Part 6A | } See new Book 4 (Integrated circuits)            |
| Part 6B |   |
| Part 7A |   |
| Part 7B |   |
| Part 8  | Microwave semiconductors and components           |
| Part 9  | Optoelectronic devices                            |



**BOOK 1 (Part 9)**

**SEMICONDUCTOR DEVICES**  
Optoelectronic devices

MULLARD LTD., MULLARD HOUSE, TORRINGTON PLACE,  
LONDON, WC1E 7HD

Telephone 01-580 6633

Telex : 264341

## DATA HANDBOOK SYSTEM

The Mullard data handbook system is made up of four sets of books, each comprising several parts; plus the Signetics technical handbook.

The four sets of books, easily identifiable by the colours on their covers, are as follows:

Book 1	(blue)	Semiconductor devices
Book 2	(orange)	Valves and tubes
Book 3	(green)	Passive components, materials, and assemblies.
Book 4	(purple)	Integrated circuits

Each part is completely reviewed annually; revised and reprinted where necessary. Revisions to previous data are indicated by an arrow in the margin.

The data sheets contained in these books are as accurate and up to date as it is reasonably possible to make them at the time of going to press. It must, however, be understood that no guarantee can be given here regarding the availability of the various devices or that their specifications may not be changed before the next edition is published.

The devices for which full data is given in these books are those around which we would recommend equipment to be designed. Where appropriate, other types no longer recommended for new equipment designs, but generally available for equipment production are listed separately with abridged data. Data sheets for these types may be obtained on request. Older devices for which data may still be obtained on request are also included in the index of the appropriate part of each book.

Requests for information regarding the data handbook system (including Signetics data) and for individual data sheets should be made to the

Technical Publications Dept.  
Mullard Limited,  
New Road,  
Mitcham,  
Surrey CR4 4XY  
Telex: 22194

Information regarding price and availability of devices must be obtained from our authorised agents or from our representatives.

Mullard manufacture and market electronic components under the **Mullard, Philips and Signetics** brands.

GENERAL SAFETY RECOMMENDATIONS  
OPTOELECTRONIC DEVICES**1. GENERAL**

When properly used and handled, optoelectronic devices do not constitute a risk to health or environment. Modern high technology materials have been used in the manufacture of these devices to ensure optimum performance. Some of these materials are toxic in certain circumstances. Mechanical or electrical damage is unlikely to give rise to any hazard, but toxic vapours may be generated if the devices are heated to destruction and it is important that the following recommendations are observed.

Care should be taken to ensure that all personnel who may handle, use or dispose of these products are aware of the necessary precautions.

Individual product data sheets will indicate whether any specific hazards are likely to be present.

**2. DISPOSAL**

These devices should be disposed of in accordance with the relevant legislation; in the United Kingdom disposal should therefore be carried out in accordance with the Deposit of Poisonous Waste Act 1972 and the Control of Pollution Act 1974, or with the latest legislation.

**3. FIRE**

Opto-electronic devices themselves, when used within the specified limits, do not present a fire hazard.

Devices can contain arsenic, beryllium, cadmium, lead, mercury, selenium, tellurium or similar hazardous materials or compounds, which, if exposed to high temperatures may emit toxic or noxious fumes.

Most packaging materials are flammable and care should be taken in the disposal of such materials, some of which will emit toxic fumes if burned.

**4. HANDLING**

Care must be exercised with those devices incorporating glass or plastic. If these devices are broken, precautions must be taken against the following hazards that may arise:—

Broken glass or ceramic. Protective clothing such as gloves should be worn.

Contamination from toxic materials and vapours. In particular, skin contact and inhalation must be avoided.

Access to live contacts which may be at high potential. Devices must be isolated from the mains supply prior to their removal.

**5. BERYLLIUM COMPOUNDS**

Beryllium oxide dust is toxic if inhaled or if particles enter a cut or an abrasion. At all times avoid handling beryllium oxide ceramics; if they are touched, the hands must be washed thoroughly with soap and water. Do nothing to beryllium oxide ceramics that may produce dust or fumes.



**5. BERYLLIUM COMPOUNDS (continued)**

Care should be taken upon eventual disposal that they are not thrown out with general industrial waste. Users seeking disposal of devices incorporating beryllium oxide ceramics should first take advice from the manufacturer's service department.

This potential hazard is present at all times from receipt to disposal of devices.

**6. CADMIUM COMPOUNDS**

Cadmium compounds are toxic. In the event of accidental breakage, cadmium dust may be released. Gloves should be worn and the dust should be mopped up with a damp cloth. Upon disposal, the cloth should be sealed in a plastic bag and the hands washed thoroughly with soap and water. Controlled disposal of devices containing cadmium compounds should be conducted in the open air or in a well ventilated area.

Inhalation of cadmium dust must be avoided.

This potential hazard is present, if breakage occurs, at all times from receipt to disposal of devices.

**7. OTHER COMPOUNDS**

Other compounds, such as those containing arsenic, indium, lead, lithium, selenium, tantalum, tellurium etc., may be toxic by ingestion or inhalation.

The above information and recommendations are given in good faith and are in accordance with the best knowledge and opinion available at the date of the compilation of the data sheets.





# GENERAL SECTION

A 



**A**

## DEFINITIONS FOR OPTOELECTRONIC DEVICES

**Activity of radiation Z**

This is the ratio of the sensitivity of a device to a given radiation to the sensitivity to a reference radiation. The device will have a defined spectral sensitivity distribution.

**Candela cd**

This is the luminous intensity, in the perpendicular direction, of a surface of 1/600 000 square metre of a black body at the temperature of freezing platinum under a pressure of 101 325 pascal.

**D\***

This is an area-independent figure of merit which is defined as t.i.e r.m.s. signal-to-noise-ratio in a 1 Hz bandwidth per unit r.m.s. incident radiant power per square root of detector area. Unless otherwise stated, it is assumed that the detector field of view is hemispherical ( $2\pi$  steradian).

D\* may be defined in response to a black body source as  $D^*(t, f, 1)$  where t is the temperature of the reference black body, usually 500 K, f is the modulation frequency in Hz and 1 represents unity bandwidth. However, it may be more practical to measure at a bandwidth greater than unity but the data sheets will always show D\* 'normalized' to unity bandwidth. Similarly, spectral D\* is symbolized by  $D^*\lambda(\lambda, f, 1)$  where  $\lambda$  is the source wavelength, f and 1 having the same representations as D\* for a black body.

unit:  $\text{cmHz}^{1/2}\text{W}^{-1}$

**Dark current  $I_d$** 

This is the current flowing in a photoelectric device in the absence of illumination.

**Dark current equivalent radiation  $E_d$** 

This is the incident radiation to give a d.c. signal output current equal to the dark current.

**Detectivity**

This is the signal-to-noise ratio per unit radiant power. Thus it is the reciprocal of the N.E.P. Care must be exercised when considering detectivity, as this term has also been used in the definition of D\*.

unit:  $\text{watts}^{-1}, \text{W}^{-1}$

**Emissivity  $\epsilon$** 

This is the ratio of the radiant exitance of a thermal radiator to that of a black body radiator at the same temperature.

**Emittance, luminous** (see Exitance, luminous)

**Emittance, radiant** (see Exitance, radiant).



**Exitance, radiant  $M_e$**

At a point on a surface, this is the radiant power leaving an element of that surface, divided by the area of the element.

$$M_e = \frac{d\Phi_e}{dA}$$

unit: watt per square metre,  $Wm^{-2}$

**Exitance, luminous  $M_v$**

At a point on a surface, this is the luminous flux leaving an element of that surface, divided by the area of that element.

$$M_v = \frac{d\Phi_v}{dA}$$

unit: lumen per square metre,  $lm\ m^{-2}$

**Fall time  $t_f$**

This is the time required for the photocurrent to fall from a stated high percentage to a stated lower percentage of the maximum value when the steady state of radiation is instantaneously removed. It is usual to consider the 90% and 10% levels.

**Rise time  $t_r$**

This is the time required for the photocurrent to rise from a stated low percentage to a stated higher percentage of the maximum value, when a steady state of radiation is instantaneously applied. It is usual to consider the 10% and 90% levels.

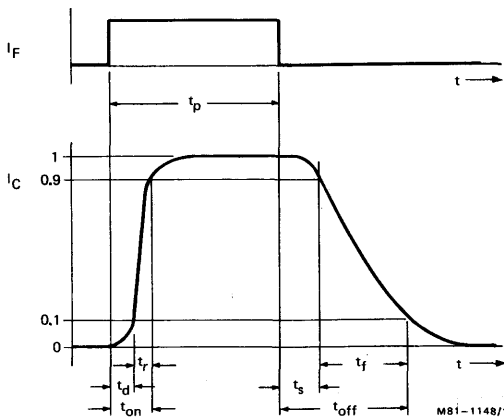

- $t_d$  : delay time
- $t_r$  : rise time
- $t_{on} (= t_d + t_r)$  : turn-on time
- $t_s$  : storage time
- $t_f$  : fall time
- $t_{off} (= t_s + t_f)$  : turn-off time



## Definitions

**Illuminance  $E_v$ , (E)**

At a point on a surface, the illuminance is the luminous flux incident on an element of the surface containing the point, divided by the area (A) of that element.

$$E_v = \frac{d\Phi_v}{dA}$$

unit: lux, lx

**Irradiance  $E_e$ , (E)**

At a point on a surface, the irradiance is the radiant power incident on an element of the surface containing the point divided by the area (A) of that element.

$$E = \frac{d\Phi_e}{dA}$$

unit: watt per square metre,  $Wm^{-2}$

**Light**

This is radiation capable of stimulating the eye. Exceptions to this definition are made where necessary in the data sheets, e.g. dark and light currents of a phototransistor and light rise time of a near-infrared light emitting diode.

**Lumen lm**

This is the luminous flux radiating from a point source of uniform luminous intensity of 1 candela, contained within a solid angle of 1 steradian.

$$1 \text{ lm} = 1 \text{ cd sr}$$

**Luminance  $L_v$** 

This is the luminous intensity ( $I_v$ ) at a point on a surface and in a given direction, of an element of that surface divided by the area of the orthogonal projection of the element on a plane perpendicular to the given direction.

unit: candela per square metre,  $cd \text{ m}^{-2}$

**Luminous flux  $\Phi_v$ , ( $\Phi$ )**

The luminous flux  $d\Phi$  of a source of luminous intensity  $I_v$  in an element of solid angle of  $d\Omega$ , is given by:

$$d\Phi_v = I_v d\Omega$$

unit: lumen, lm



### Luminous intensity $I_v$ (I)

For a source of given direction, the luminous intensity is the luminous flux leaving the source, or an element of the source, in an element of solid angle ( $\Omega$ ) containing the given direction, divided by that element of solid angle.

$$I_v = \frac{d\Phi_v}{d\Omega}$$

unit: candela, cd

### Lux lx

This is the illumination produced when 1 lumen of flux falls on a surface area 1 square metre. It will be seen that an illumination of 1 lux is produced on an area 1 square metre at a distance of 1 metre from a point source of 1 candela.

### Noise equivalent irradiation

This is the value of incident radiation which, when modulated in a stated manner, produces a signal output power equal to the noise power, both of which are in a stated bandwidth.

### Noise Equivalent Power (N.E.P.)

Noise sets a limit to the smallest signal that can be detected. It is usually specified as the r.m.s. value of the electrical output measured in a 1 Hz bandwidth at a specified centre frequency. A more useful quantity is the N.E.P. This is the r.m.s. incident radiant power which gives rise to an r.m.s. signal voltage or current equal to the r.m.s. noise voltage or current, normally in a bandwidth of 1 Hz. This parameter is, in general, a function of wavelength and chopping frequency.

$$\text{N.E.P.} = \frac{\text{noise per unit bandwidth}}{\text{responsivity}} \quad \text{and is related to } D^* \text{ by } \text{N.E.P.} = \frac{A (\Delta f)^{1/2}}{D^*}$$

As with  $D^*$  and detectivity (defined below), N.E.P. may be either black body or spectral, depending upon the reference source.

unit: watt, W

### Photocurrent $I_{ph}$

This is the change in output current from the photocathode due to incident radiation.

### Pulsed operation

Under these conditions higher peak power dissipation is possible. In general, the shorter the pulse and lower the frequency, the lower is the temperature that the junction reaches.

By analogy with thermal resistance:

$$Z_{th} = \frac{T_j - T_{amb}}{P_{tot}}$$



## Definitions

**Quantum efficiency**

This is the ratio of the number of emitted photoelectrons to the number of incident photons. Quantum efficiency (Q.E.) at a given wavelength of incident radiation may be calculated as follows:-

$$\text{Q.E.} = \frac{\text{Constant} \times S_k}{\lambda}$$

- where:  $S_k$  = spectral sensitivity ( $A \cdot W^{-1}$ ) at wavelength  $\lambda$   
 $\lambda$  = wavelength of incident radiation (nm)  
 constant =  $\frac{hc}{e} = 1.24 \times 10^3 \text{ WnmA}^{-1}$   
 $h$  = Planck's constant ( $6.6256 \times 10^{-34} \text{ js}$ )  
 $c$  = velocity of electromagnetic waves in vacuo =  $2.997925 \times 10^8 \text{ ms}^{-1}$   
 $e$  = elementary charge =  $1.60210 \times 10^{-19} \text{ coulomb}$  or  $4.80298 \times 10^{-19} \text{ e.s.u.}$

**Quantum efficiency characteristic**

This is the relationship, usually shown by a graph, between the wavelength and the quantum efficiency.

**Radiance  $L_e$** 

This is the radiant intensity ( $I_e$ ) at a point on a surface and in a given direction, of an element of that surface, divided by the area of the orthogonal projection of the element on a plane perpendicular to the given direction.

unit: watt per steradian square metre,  $W(\text{sr m}^{-2})$

**Radiant flux,  $\Phi_e$  ( $\Phi, P$ )**

This is the power emitted, transferred or received as radiation, i.e. the radiant energy ( $dQ_e$ ) emitted per second.

$$\Phi_e = \frac{dQ_e}{dt}$$

unit: watt, W

**Radiant intensity  $I_e$ , ( $I$ )**

For a source of given direction, the radiant intensity is the radiant power leaving the source, or an element of the source, in an element of solid angle ( $\Omega$ ) containing the given direction, divided by that element of solid angle.

$$I_e = \frac{d\Phi_e}{d\Omega}$$

unit: watt per steradian,  $W\text{sr}^{-1}$



**Radiant power** (see Radiant flux)

**Refractive index, absolute  $n$**

This is the ratio of the velocity of light in vacuo to that in a particular medium. For most practical purposes the velocity of light in vacuo may be replaced by that in air.

**Responsivity**

This is the ratio of the r.m.s. signal in volts to the r.m.s. value of the incident, chopped, radiant power  
unit:  $VW^{-1}$

**Rise time (see Fall time)**

**Saturation current  $I_{CE sat}$**

This is the output current of a photosensitive device which is not changed by an increase of either:—

- a. the irradiance under constant operating conditions or
- b. the operating voltage under constant irradiance.

**Saturation voltage  $V_{CE sat}$**

This is the lowest operating voltage which causes no change in photocurrent when this voltage is increased with constant radiation.

**Sensitivity, absolute spectral  $s(\lambda)$  note 1**

This is the radiant sensitivity for monochromatic radiation of a stated wavelength.

**Sensitivity, absolute spectral characteristic note 1**

This is the relationship, usually shown in graphical form, between the wavelength and the absolute spectral sensitivity.

**Sensitivity, dynamic  $S_D$  note 1**

Under stated operating conditions, this is the ratio of the variation of the photocurrent of the device to the initiating small variation in the incident radiant or luminous power.

Note: distinction is made between luminous dynamic sensitivity and radiant sensitivity.

**Sensitivity, luminous  $S_L$  note 1**

This may be expressed as either:—

- a. the ratio of the photocurrent of the device to the incident luminous flux, expressed in amperes per lumen, or,
- b. the ratio of the photocurrent of the device to the incident illuminance, expressed in amperes per lux.

**Sensitivity, radiant  $S_R$  note 1**

This may be expressed as either:—

- a. The ratio of the photocurrent of the device to the incident radiant power, expressed in amperes per watt, or,
- b. the ratio of the photocurrent of the device to the incident irradiance, expressed in amperes per square metre.





## Definitions

**Sensitivity, relative spectral  $s(\lambda)_{rel}$**  note 1

This is the ratio of the radiant sensitivity at a particular wavelength to the radiant sensitivity at a reference wavelength, usually the wavelength of maximum response.

Note: for non-linear detectors, it is necessary to refer to constant photocurrent at all wavelengths.

**Sensitivity, relative spectral characteristic** note 1

This is the relationship between wavelength and the relative spectral sensitivity.

**Sensitivity, spectral characteristic** note 1

This is the relationship, usually shown in graphical form, between the wavelength and the absolute or relative spectral sensitivity.

**Steradian sr**

A cone is taken from a sphere such that the surface area of the curved base of this cone is equal to the square of the radius  $r$  of the sphere. The solid angle at the apex of the cone is known as a steradian (1 sr). Since the surface area of a sphere is  $4\pi r^2$ , it follows that the complete solid angle at the centre of a sphere is  $4\pi$  steradian.

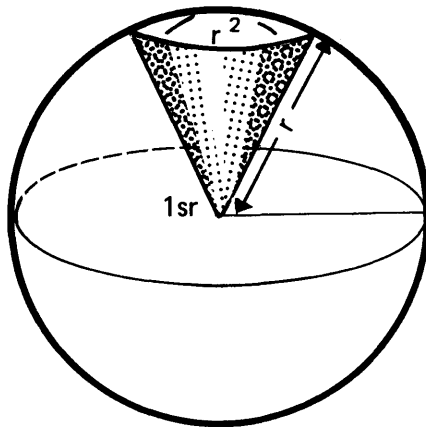

## Note 1

These definitions apply more directly to photocathode sensitivity. For devices in which it is necessary to define the anode (overall) sensitivity, the signal output current should be considered instead of the photocurrent.



**Temperature, colour  $T_c$**

The colour temperature of a radiator is the temperature of a black body which has the same, or approximately the same, spectral radiation distribution in the visible range as the radiator under consideration.

**Temperature, distribution  $T_d$**

This is the temperature of a black body at which the spectral radiation distribution of the radiator under consideration, in a given wavelength range is proportional or approximately proportional to the spectral radiation distribution of the black body. If the wavelength range given includes visible radiation, then the distribution temperature corresponds to the colour temperature.

**Thermal resistance**

This is the ratio of temperature rise to power dissipation or

$$R_{th} = \frac{T_j - T_{amb}}{P_{tot}}$$

The thermal resistance is also the reciprocal of the derating factor.

**Wave number**

This is the reciprocal of the wavelength in centimetres  $\frac{1}{\lambda}$

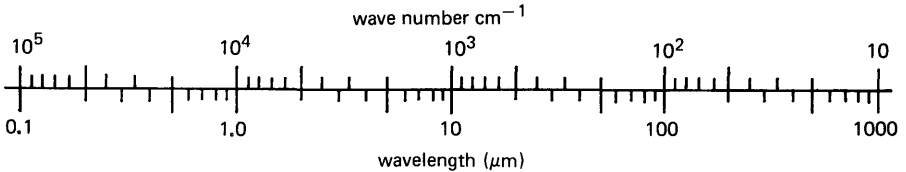

Definitions

Conversion table of luminance units

units	cd m <sup>-2</sup>	asb	sb	L	cd ft <sup>-2</sup>	fL	cd in <sup>-2</sup>
1 cd m <sup>-2</sup> (candela per square metre)	1	$\pi$	$10^{-4}$	$\pi 10^{-4}$	$9.29 10^{-2}$	0.2919	$6.45 10^{-4}$
1 asb (Apostilb)	$\frac{1}{\pi}$	1	$\frac{1}{\pi} 10^{-4}$	$10^{-4}$	$2.957 10^{-2}$	0.0929	$2.054 10^{-4}$
1 sb (Stilb)	$10^{-4}$	$\pi 10^4$	1	$\pi$	929	2919	6.452
1 L (Lambert)	$\frac{1}{\pi} 10^4$	$10^4$	$\frac{1}{\pi}$	1	$2.957 10^2$	929	2.054
1 cd ft <sup>-2</sup> (candela per square foot)	10.764	33.82	$1.076 10^{-3}$	$3.382 10^{-3}$	1	$\pi$	$6.94 10^{-3}$
1 fL (footlambert)	3.426	10.764	$3.426 10^{-4}$	$1.0764 10^{-3}$	$\frac{1}{\pi}$	1	$2.211 10^{-3}$
1 cd in <sup>-2</sup> (candela per square inch)	1550	4869	0.155	0.4869	144	452.4	1

Conversion table of illumination units

units	lx	lm cm <sup>-2</sup>	fc
1 lx (lux)	1	$10^{-4}$	0.0929
1 lm cm <sup>-2</sup> (lumen per square centimetre)	$10^4$	1	$0.0929 10^4$
1 fc (footcandle)	10.764	$10.764 10^{-4}$	1

Summary of terms and definitions

radiation quantities, symbols and units			light quantities, symbols and units			relationship	simplified relationship
quantity	symbol	unit	quantity	symbol	unit		
radiant energy	$Q_e$	Ws	quantity of light	$Q_v$	lms	—	—
radiant flux	$\Phi_e$	W	luminous flux	$\Phi_v$	lm	$\Phi = \frac{dQ}{dt}$	$\Phi = \frac{Q}{t}$
radiant exitance	$M_e$	Wm <sup>-2</sup>	luminous exitance	$M_v$	lm m <sup>-2</sup> , lx	$M = \frac{d\Phi}{dA_1}$	$M = \frac{\Phi}{A_1}$
radiant intensity	$I_e$	Wsr <sup>-1</sup>	luminous intensity	$I_v$	lm sr <sup>-1</sup> , cd	$I = \frac{d\Phi}{d\Omega}$	$I = \frac{\Phi}{\Omega}$
radiance	$L_e$	Wsr <sup>-1</sup> m <sup>-2</sup>	luminance	$L_v$	lm sr <sup>-1</sup> m <sup>-2</sup> , $\frac{cd}{m^2}$	$L = \frac{dI}{dA_1 \cos \epsilon}$	$L = \frac{I}{A_1 \cos \epsilon}$
irradiance	$E_e$	Wm <sup>-2</sup>	illuminance	$E_v$	lm m <sup>-2</sup> , lx	$E = \frac{d\Phi}{dA_2}$	$E = \frac{\Phi}{A_2}$
irradiation	$H_e$	Ws m <sup>-2</sup>	illumination	$H_v$	lms m <sup>-2</sup> , lx	$H = \frac{dQ}{dA_2}$	$H = \frac{Q}{A_2}$





## LETTER SYMBOLS FOR TRANSISTORS AND SIGNAL DIODES

## LETTER SYMBOLS FOR CURRENTS, VOLTAGES AND POWERS

## Basic letters

The basic letters to be used are:

I, i = current

V, v = voltage

P, p = power

Lower-case basic letters shall be used for the representation of instantaneous values which vary with time.

In all other instances upper-case basic letters shall be used.

## Subscripts

A, a	Anode terminal
(AV), (av)	Average value
B, b	Base terminal
(BR)	Breakdown
C, c	Collector terminal
D, d	Drain terminal
E, e	Emitter terminal
F, f	Forward
G, g	Gate terminal
K, k	Cathode terminal
M, m	Maximum or peak value
O, o	As third subscript: The terminal not mentioned is open circuited
R, r	As first subscript: Reverse. As second subscript: Repetitive.
	As third subscript: With a specified resistance between the terminal not mentioned and the reference terminal.
(RMS), (rms)	R.M.S. value
S, s	{ As first or second subscript: Source terminal (for FETS only) As second subscript: Non-repetitive (not for FETS) As third subscript: Short circuit between the terminal not mentioned and the reference terminal.
X, x	Specified circuit
Z, z	Replaces R to indicate the actual working voltage, current or power of voltage reference and voltage regulator diodes.

Note: No additional subscript is used for d.c. values.



Upper-case subscripts shall be used for the indication of:

- a) continuous (d.c.) values (without signal)  
Example  $I_B$
- b) instantaneous total values  
Example  $i_B$
- c) average total values  
Example  $I_{B(AV)}$
- d) peak total values  
Example  $I_{BM}$
- e) root-mean-square total values  
Example  $I_{B(RMS)}$

Lower-case subscripts shall be used for the indication of values applying to the varying component alone:

- a) instantaneous values  
Example  $i_b$
- b) root-mean-square values  
Example  $I_{b(rms)}$
- c) peak values  
Example  $I_{bm}$
- d) average values  
Example  $I_{b(av)}$

Note: If more than one subscript is used, subscript for which both styles exist shall either be all upper-case or all lower-case.

*Additional notes for subscripts*

**Subscripts for currents**

Transistors: If it is necessary to indicate the terminal carrying the current, this should be done by the first subscript (conventional current flow from the external circuit into the terminal is positive).

Examples:  $I_B$ ,  $i_B$ ,  $i_b$ ,  $I_{bm}$

Diodes: To indicate a forward current (conventional current flow into the anode terminal) the subscript F or f should be used; for a reverse current (conventional current flow out of the anode terminal) the subscript R or r should be used.

Examples:  $I_F$ ,  $I_R$ ,  $i_F$ ,  $I_{f(rms)}$



**Subscripts for voltages**

Transistors: If it is necessary to indicate the points between which a voltage is measured, this should be done by the first two subscripts. The first subscript indicates the terminal at which the voltage is measured and the second the reference terminal or the circuit node. Where there is no possibility of confusion, the second subscript may be omitted.

Examples:  $V_{BE}$ ,  $v_{BE}$ ,  $v_{be}$ ,  $V_{bem}$

Diodes: To indicate a forward voltage (anode positive with respect to cathode), the subscript F or f should be used: for a reverse voltage (anode negative with respect to cathode) the subscript R or r should be used.

Examples:  $V_F$ ,  $V_R$ ,  $v_F$ ,  $V_{rm}$

**Subscripts for supply voltages or supply currents**

Supply voltages or supply currents shall be indicated by repeating the appropriate terminal subscript.

Examples:  $V_{CC}$ ,  $I_{EE}$

Note: It is necessary to indicate a reference terminal, this should be done by a third subscript

Example:  $V_{CCE}$

**Graphical representation of subscripts for collector current**

The figure below represents a transistor collector current as a function of time. It consists of a continuous (d.c.) current and a varying component.

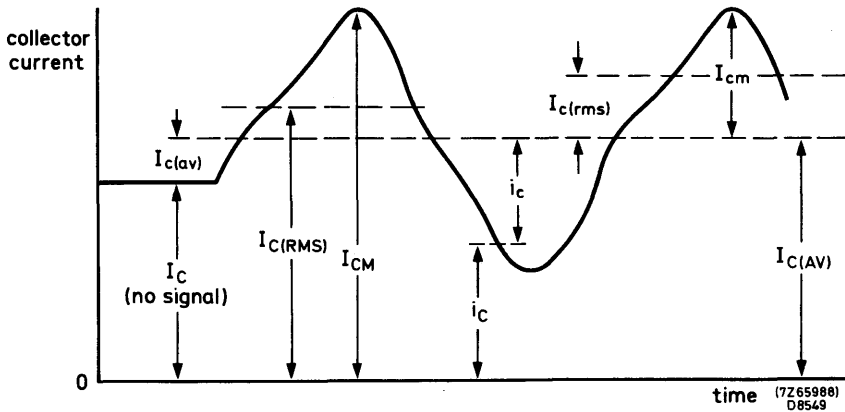

## LETTER SYMBOLS FOR ELECTRICAL PARAMETERS

### Definition

For the purpose of this publication, the term "electrical parameter" applies to elements of electrical equivalent circuits, electrical impedances and admittances and inductance and capacitances.

### Basic letters

The following is a list of the most important basic letters used for electrical parameters or semiconductor devices.

B,b	= susceptance; imaginary part of an admittance
C	= capacitance
G,g	= conductance; real part of an admittance
H,h	= hybrid parameter
L	= inductance
R,r	= resistance, real part of an impedance
X,x	= reactance; imaginary part of an impedance
Y,y	= admittance;
Z,z	= impedance;

Upper-case letters shall be used for the representation of:

- electrical parameters of external circuits and of circuits in which the device forms only a part:
- all inductances and capacitances.

Lower-case letters shall be used for the representation of electrical parameters inherent in the device (with the exception of inductances and capacitances).

### Subscripts

The following is a list of the most important general subscripts used for electrical parameters of semiconductor devices:

F,f	= forward; forward transfer
I,i (or 1)	= input
L,l	= load
O,o (or 2)	= output
R,r	= reverse, reverse transfer
S,s	= source

Examples:  $Z_S$ ,  $h_f$ ,  $h_F$





The upper-case variant of a subscript shall be used for the designation of static (d.c.) values.

Examples:  $h_{FE}$  = static value of forward current transfer ratio in common-emitter configuration (d.c. current gain)

$R_E$  = d.c. value of the external emitter resistance.

Note: The static value is the slope of the line from the origin to the operating point on the appropriate characteristic curve, i.e. the quotient of the appropriate electrical quantities at the operating point.

The lower-case variant of a subscript shall be used for the designation of small-signal values.

Examples:  $h_{fe}$  = small-signal value of the short-circuit forward current transfer ratio in common-emitter configuration.

$Z_e = R_e + jX_e$  = small-signal value of the external impedance.

Note: If more than one subscript is used, subscripts for which both styles exist shall either be all upper-case or all lower-case

Examples:  $h_{FE}$ ,  $h_{fe}$





PRO ELECTRON TYPE DESIGNATION CODE  
FOR SEMICONDUCTOR DEVICES

This type designation code applies to most optoelectronic semiconductor devices and multiples of such devices.

The type number may consist of either two or three letters, followed by a serial number. The first and second letters are common to consumer and industrial products and are explained below.

**First letter**

This gives information about the material used for the active part of the device.

- B. Silicon or other material with a band gap of 1.0 to 1.3 eV.
- C. Gallium Arsenide or other material with a band gap of 1.3 eV or more.
- R. Compound materials, e.g. Cadmium Sulphide.

**Second letter**

This indicates the function for which the device is primarily designed.

- N. Photocoupler
- P. Radiation detector, e.g. photo-transistor.
- Q. Radiation generator, e.g. light emitting diode (L.E.D.).

**Serial number**

For consumer products, the serial number consists of a three figure number. For industrial products, it consists of a letter, followed by a two figure number. The letter normally has no fixed meaning.

**Variants**

These may be indicated by a suffix letter which has no fixed meaning, e.g. RPY90A, RPY90B etc.

**Sub-classifications**

These may be used for devices offering a range of available selections, e.g. CQY94 – II, CQY94 – III.





## RATING SYSTEM

The rating system described is that recommended by the International Electrotechnical Commission (IEC) in its publication No. 134.

### DEFINITION OF TERMS USED

#### Electronic device

A tube, or semiconductor, which may be referred to in our data as a device.

#### Characteristic

A characteristic is an inherent and measurable property of a device. Such a property may be electrical, mechanical, thermal, hydraulic, electro-magnetic or nuclear and may be expressed as a value at stated or recognized conditions. A characteristic may also be a set of related values, usually shown in graphical form.

#### Rating

This is a value which establishes either a limiting capability or a limiting condition for a device. It is defined at specified values of environment and operation and may be stated in any suitable terms.

#### Rating system

This is the set of principles upon which ratings are established and which determines their interpretation. The rating system indicates the division of responsibility between the device manufacturer and the circuit designer, with the object of ensuring that the operating conditions do not exceed the ratings.

### ABSOLUTE MAXIMUM RATING SYSTEM

Absolute maximum ratings are the limiting values of operating and environmental conditions, applicable to any device of a specified type as defined by its published data, which should not be exceeded. These values are chosen by the device manufacturer to provide acceptable working conditions for the device. No account is taken of equipment variations, environmental variations, the effects of changes in operating conditions due to variations in the characteristics of the device under consideration, or of any other devices in the equipment.

The equipment design must ensure that no absolute maximum value is exceeded with any device under the worst operating conditions. Variations of supply and characteristics of the device under consideration, and of all other devices in the equipment, must be taken into account.





# PHOTODIODES AND PHOTOTRANSISTORS

BPW22A  
BPW50  
BPX25,9  
BPX95C

**B**





**B**



## GENERAL EXPLANATORY NOTES

### PHOTODIODES AND PHOTOTRANSISTORS

#### 1. INTRODUCTION

Silicon photosensitive devices have a defined junction similar to general purpose semiconductor diodes and transistors.

Light falling on a device produces pairs of charge carriers in the semiconductor chip which contribute to the conduction mechanism as soon as they arrive at the electric field of the junction.

In addition, the junction has an effect as a result of the existing potential barrier; only a very small current can flow in darkness in the reverse direction. Without the junction, this current would be greater by several powers of 10, due to the intrinsic conductivity.

The manufacturing process does not differ in principle from that used for making conventional semi-conductors. However, the doping technique may differ slightly, as it is important for the junction to be located close to the surface of the chip and to be kept as near as possible within the penetration range of the incident radiation, so that a large number of the charge carriers produced may be used for the photocurrent.

Silicon is used for these products because it has a low dependence on temperature, particularly with regard to dark current, and has a maximum spectral sensitivity in the range 800 to more than 900 nm. To increase the sensitivity, some silicon photosensitive devices are supplied with a domed (lensed) encapsulation.

#### 2. TYPES OF PHOTOSENSITIVE SILICON DEVICES

##### 2.1 Photodiodes

A photodiode has a PN junction and is operated in the reverse mode, i.e. biased. The functioning of these devices depends on the fact that the reverse current varies with illumination.

##### 2.2 Phototransistors

A phototransistor has two junctions. In design, it does not differ from a transistor and is connected with the same polarity to a voltage source. Phototransistors, in addition to generating charge carriers when illuminated, use the amplification properties of a transistor. Consequently, phototransistors have a high sensitivity compared with photodiodes. They do not, however, reach the same high cut-off frequencies as photodiodes of comparable construction.

The highest sensitivity obtained with a phototransistor is found when it is operated with an open-circuited base.





### SILICON PHOTOTRANSISTOR

N-P-N silicon phototransistor in epoxy resin encapsulation intended for optical coupling and encoding. The base is inaccessible. Combination with LED CQY58A is recommended.

#### QUICK REFERENCE DATA

Collector-emitter voltage	$V_{CEO}$	max.	50 V
Collector current (d.c.)	$I_C$	max.	25 mA
Total power dissipation up to $T_{amb} = 25\text{ }^\circ\text{C}$	$P_{tot}$	max.	100 mW
Collector dark current $V_{CE} = 30\text{ V}; E = 0$	$I_{CEO(D)}$	<	100 nA
Collector light current $V_{CE} = 5\text{ V}; E_e = 1\text{ mW/cm}^2; \lambda_{pk} = 930\text{ nm}$	$I_{CEO(L)}$	>	1,5 mA
Wavelength at peak response	$\lambda_{pk}$	typ.	800 nm

This data must be read in conjunction with GENERAL SAFETY RECOMMENDATIONS – OPTOELECTRONIC DEVICES

#### MECHANICAL DATA

Dimensions in mm

Fig. 1 SOD-53D.

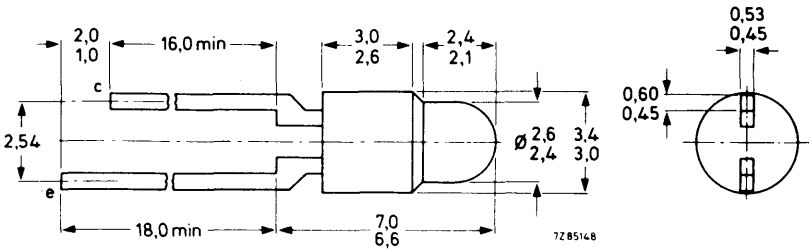

**RATINGS**

Limiting values in accordance with the Absolute Maximum System (IEC 134)

Collector-emitter voltage	$V_{CEO}$	max.	50 V
Emitter-collector voltage	$V_{ECO}$	max.	7 V
Collector current			
d.c.	$I_C$	max.	25 mA
peak value	$I_{CM}$	max.	50 mA
Total power dissipation up to $T_{amb} = 25\text{ }^\circ\text{C}$	$P_{tot}$	max.	100 mW
Storage temperature	$T_{stg}$		-55 to +100 $^\circ\text{C}$
Junction temperature	$T_j$	max.	100 $^\circ\text{C}$
Lead soldering temperature			
> 3,5 mm from the body; $t_{sld} < 7\text{ s}$	$T_{sld}$	max.	240 $^\circ\text{C}$

**THERMAL RESISTANCE**

From junction to ambient,  
device mounted on printed-circuit board

$R_{thj-a} = 750\text{ }^\circ\text{C/W}$

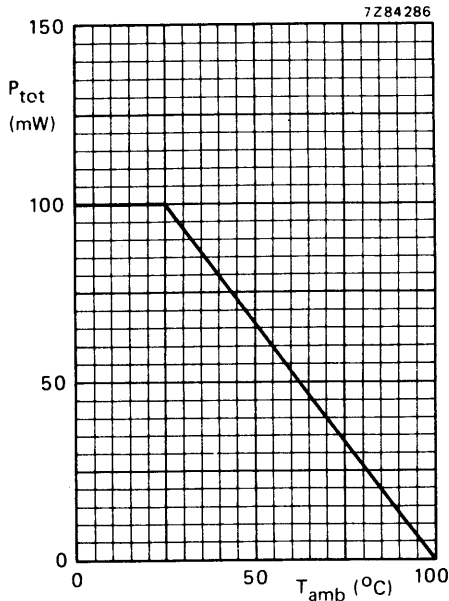

Fig. 2 Power derating curve versus ambient temperature.



**CHARACTERISTICS**

$T_j = 25\text{ }^\circ\text{C}$  unless otherwise specified

Collector dark current

$V_{CE} = 30\text{ V}; E = 0$

$I_{CEO(D)} < 100\text{ nA}$

Collector light current

$V_{CE} = 5\text{ V}; E_e = 1\text{ mW/cm}^2; \lambda_{pk} = 930\text{ nm}$

**BPW22A-I**  
**BPW22A-II**

$I_{CEO(L)} \quad 1,5\text{ to }8\text{ mA}$   
 $I_{CEO(L)} \quad 5\text{ to }25\text{ mA}$

Collector-emitter saturation voltage

$I_C = 1\text{ mA}; E_e = 1\text{ mW/cm}^2; \lambda_{pk} = 930\text{ nm}$

$V_{CEsat} < 0,4\text{ V}$

Wavelength at peak response

$\lambda_{pk} \text{ typ. } 800\text{ nm}$

Bandwidth at half height

$B_{50\%} \text{ typ. } 400\text{ nm}$

Beamwidth between half sensitivity directions

$\alpha_{50\%} \text{ typ. } \pm 10^\circ$

Switching times (see Figs 3, 4, 9 and 10)

$I_{Con} = 2\text{ mA}; V_{CC} = 5\text{ V}; R_E = 100\ \Omega; T_{amb} = 25\text{ }^\circ\text{C}$

turn-on time

$t_{on} \text{ typ. } 3\ \mu\text{s}$

turn-off time

$t_{off} \text{ typ. } 3\ \mu\text{s}$

$I_{Con} = 2\text{ mA}; V_{CC} = 5\text{ V}; R_E = 1\text{ k}\Omega; T_{amb} = 25\text{ }^\circ\text{C}$

turn-on time

$t_{on} \text{ typ. } 12,0\ \mu\text{s}$

turn-off time

$t_{off} \text{ typ. } 12,5\ \mu\text{s}$

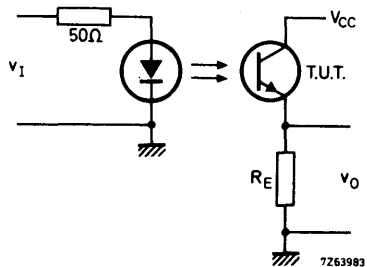

Fig. 3 Switching circuit with light emitting diode CQY58A. T.U.T. = BPW22A.

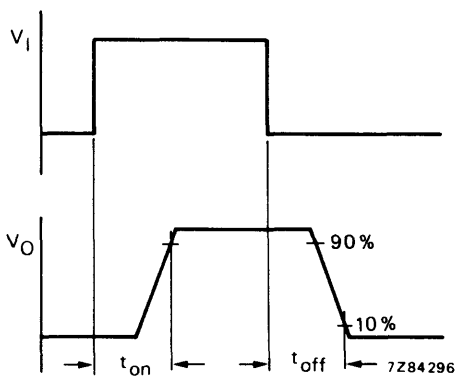

Fig. 4 Input and output switching waveforms.

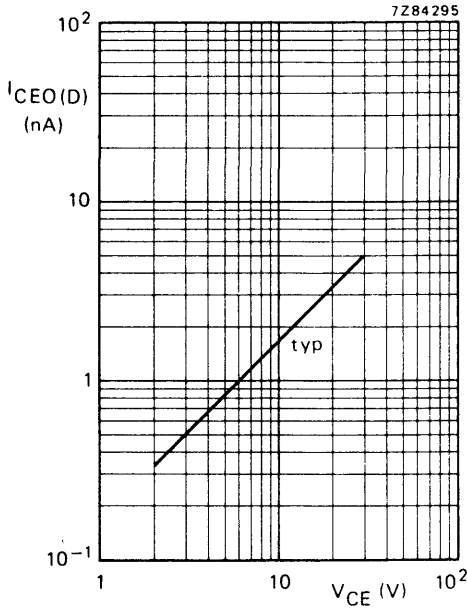

Fig 5  $E = 0$ ;  $T_j = 25^\circ\text{C}$ .

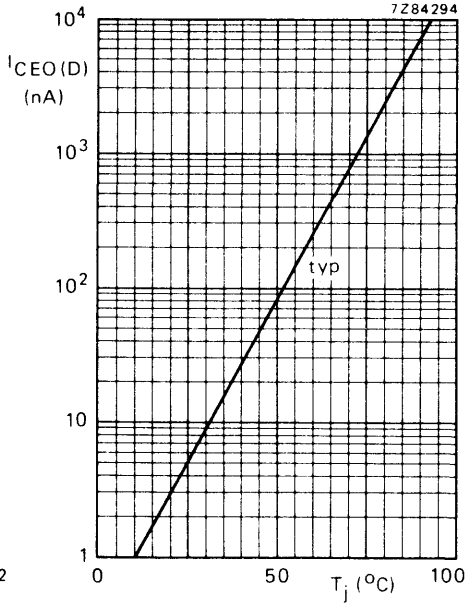

Fig. 6  $E = 0$ ;  $V_{CE} = 30\text{ V}$ .

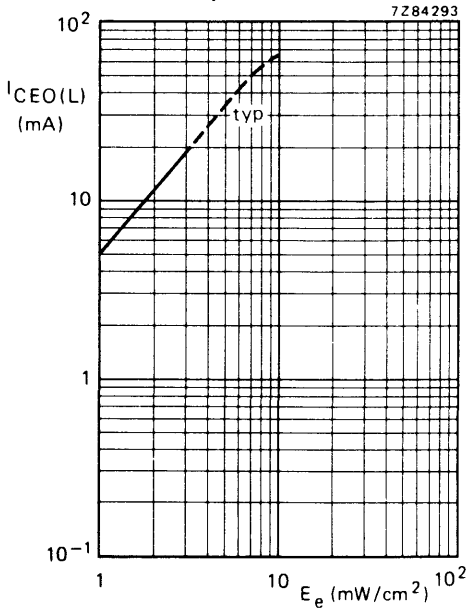

Fig. 7 GaAs source;  $\lambda_{pk} = 930\text{ nm}$ ;  $V_{CE} = 5\text{ V}$ ;  $T_j = 25^\circ\text{C}$ .

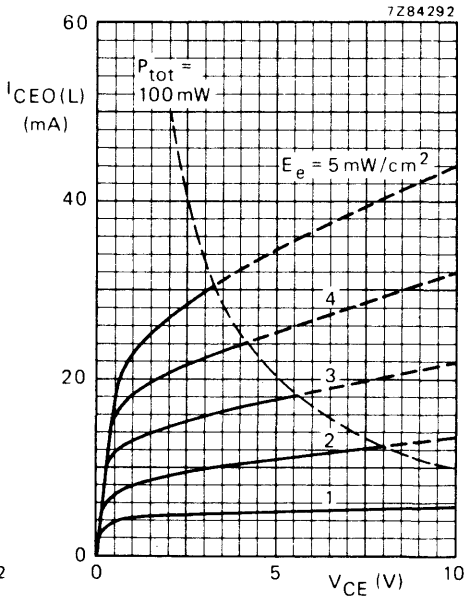

Fig. 8  $\lambda_{pk} = 930\text{ nm}$ ;  $T_j = 25^\circ\text{C}$ ; typical values.



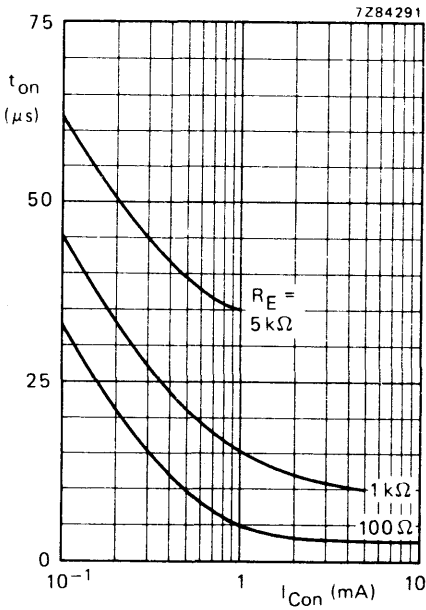

Fig. 9  $V_{CC} = 5 V$ ;  $T_{amb} = 25^\circ C$ ; typical values; see also Figs 3 and 4.

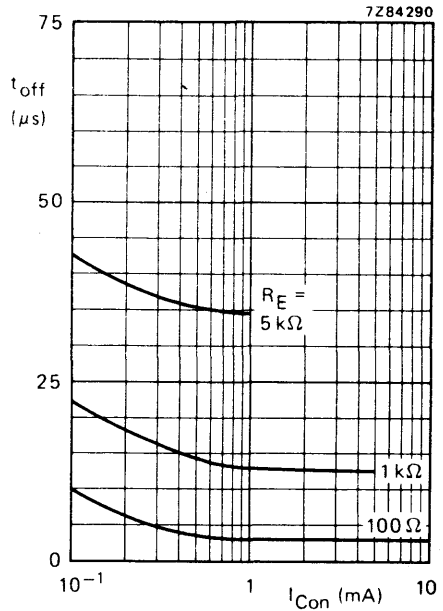

Fig. 10  $V_{CC} = 5 V$ ;  $T_{amb} = 25^\circ C$ ; typical values; see also Figs 3 and 4.

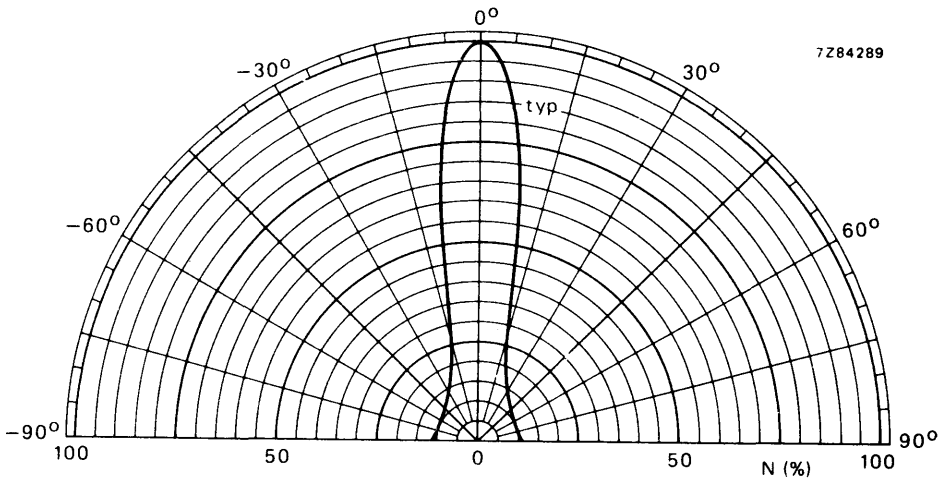

Fig. 11.



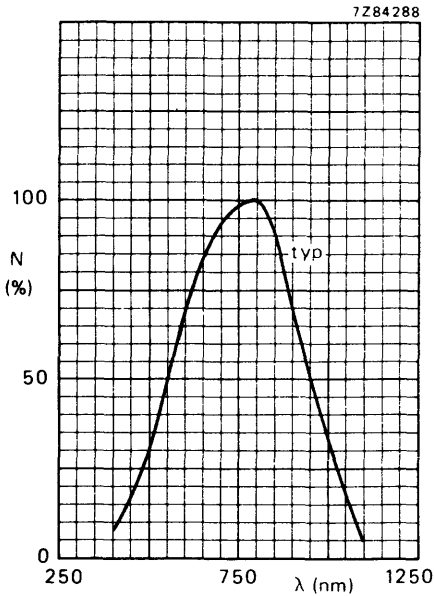

Fig. 12 Spectral response.

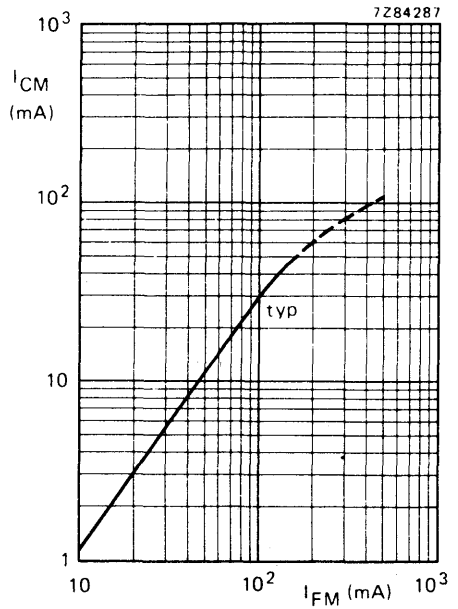

Fig. 13  $V_{CE} = 5\text{ V}$ ;  $t_p(I_{FM}) = 10\ \mu\text{s}$ ;  $T = 1\text{ ms}$ ;  
 $d^* = 10\text{ mm}$ ;  $T_{amb} = 25\text{ }^\circ\text{C}$ .

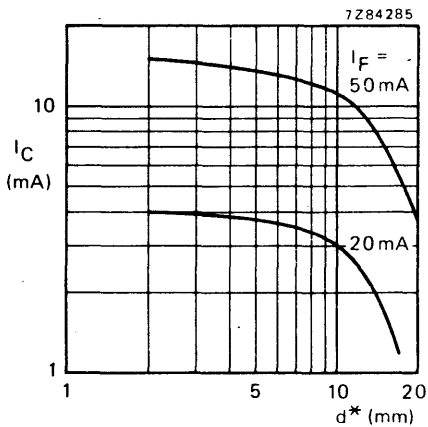

Fig. 14  $V_{CE} = 5\text{ V}$ ;  $T_{amb} = 25\text{ }^\circ\text{C}$ ;  
typical values.

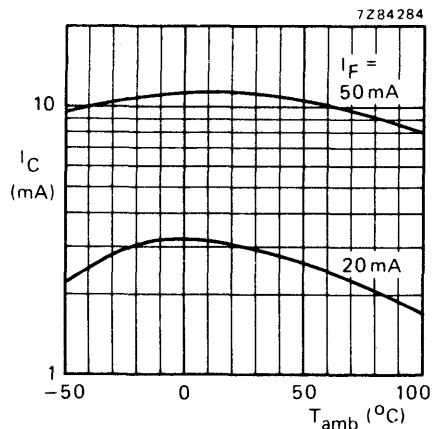

Fig. 15  $V_{CE} = 5\text{ V}$ ;  $d^* = 10\text{ mm}$ ;  
typical values.

\*  $d$  = shortest free distance of mechanical on-axis when BPW22A is coupled with CQY58A.





## SILICON PHOTO P-I-N DIODE

Silicon photo p-i-n diode in a plastic envelope with an infrared filter.

## QUICK REFERENCE DATA

Continuous reverse voltage	$V_R$	max.	32 V
Total power dissipation up to $T_{amb} = 47,5\text{ }^\circ\text{C}$	$P_{tot}$	max.	150 mW
Junction temperature	$T_j$	max.	100 $^\circ\text{C}$
Dark reverse current $V_R = 10\text{ V}; E_e = 0$	$I_{R(D)}$	<	30 nA
Light reverse current $V_R = 5\text{ V}; E_e = 1\text{ mW/cm}^2; \lambda = 930\text{ nm}$	$I_{R(L)}$	>	30 $\mu\text{A}$
Wavelength at peak response $V_R = 5\text{ V}$	$\lambda_{pk}$	typ.	930 nm
Sensitive area	A	typ.	5 mm <sup>2</sup>

This data must be read in conjunction with GENERAL SAFETY RECOMMENDATIONS – OPTOELECTRONIC DEVICES

## MECHANICAL DATA

Dimensions in mm

Fig. 1 SOD-67.

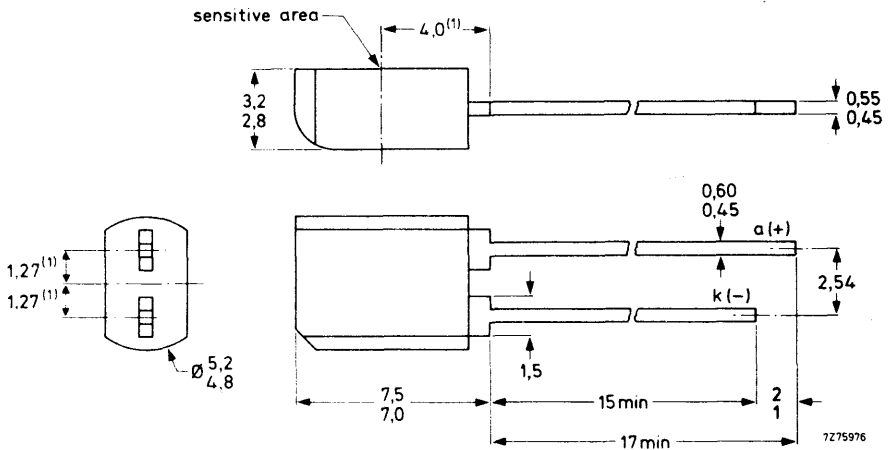

(1) Reference for the positional tolerance of the sensitive area.



**RATINGS**

Limiting values in accordance with the Absolute Maximum System (IEC 134)

Continuous reverse voltage	$V_R$	max.	32 V
Total power dissipation up to $T_{amb} = 47,5\text{ }^\circ\text{C}$	$P_{tot}$	max.	150 mW
Storage temperature	$T_{stg}$		-30 to + 100 $^\circ\text{C}$
Junction temperature	$T_j$	max.	100 $^\circ\text{C}$
Lead soldering temperature up to the seating plane; $t_{sld} < 10\text{ s}$	$T_{sld}$	max.	260 $^\circ\text{C}$

**THERMAL RESISTANCE**

From junction to ambient in free air	$R_{th\ j-a}$	=	350 $^\circ\text{C/W}$
--------------------------------------	---------------	---	------------------------

**CHARACTERISTICS**

$T_j = 25\text{ }^\circ\text{C}$

Dark reverse current  
 $V_R = 10\text{ V}; E_e = 0$

$I_{R(D)}$	typ.	2 nA
	<	30 nA

Light reverse current  
 $V_R = 5\text{ V}; E_e = 1\text{ mW/cm}^2; \lambda = 930\text{ nm}$

$I_{R(L)}$	>	30 $\mu\text{A}$
	typ.	45 $\mu\text{A}$

Reverse voltage  
 $I_R = 0,1\text{ mA}; E_e = 0$

$V_R$	>	32 V
-------	---	------

Wavelength at peak response  
 $V_R = 5\text{ V}$

$\lambda_{pk}$	typ.	930 nm
----------------	------	--------

Diode capacitance  
 $V_R = 3\text{ V}$

$C_d$	typ.	17 pF
	<	30 pF

$V_R = 0$

$C_d$	typ.	50 pF
-------	------	-------

Light switching times (see Figs 2 and 3)

Rise time and fall time

$V_{KK} = 10\text{ V}; R_A = 1\text{ k}\Omega$

$t_r, t_f$	typ.	50 ns
------------	------	-------

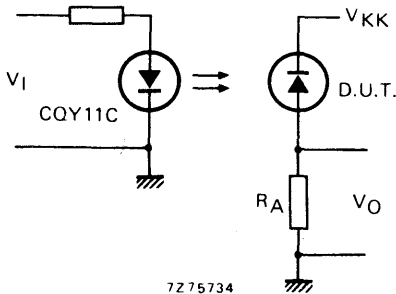

Fig. 2 Switching circuit.

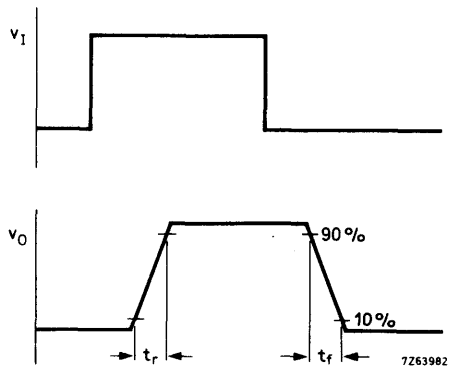

Fig. 3 Input and output switching waveforms.



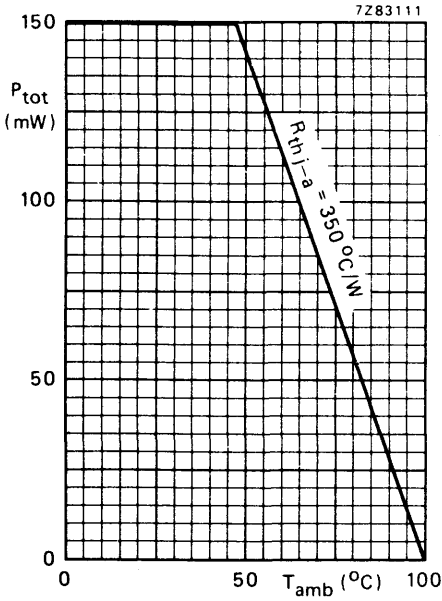

Fig. 4 Maximum permissible power dissipation as a function of temperature.

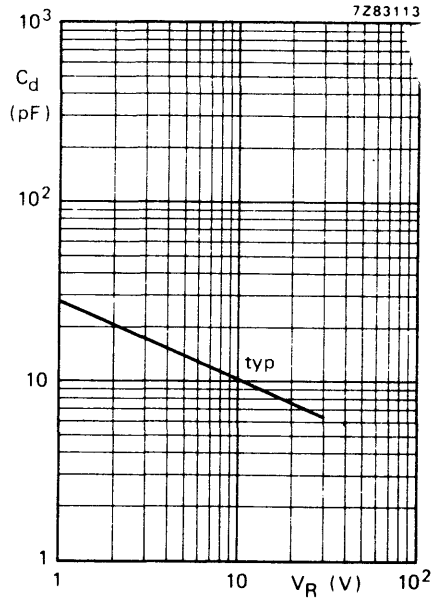

Fig. 5  $T_{amb} = 25^{\circ}C$ .



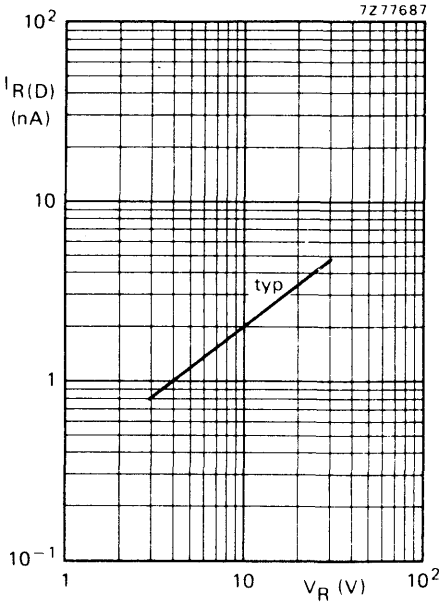

Fig. 6  $E = 0$ ;  $T_{amb} = 25\text{ }^{\circ}\text{C}$ .

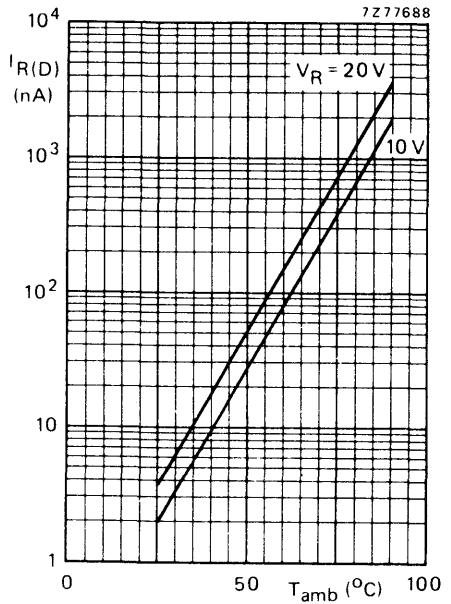

Fig. 7  $E = 0$ ; typical values.

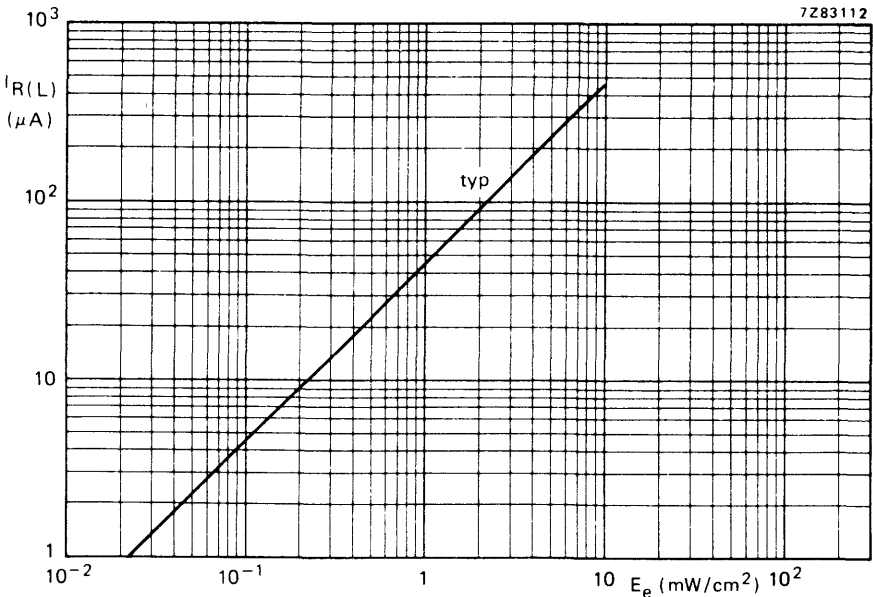

Fig. 8  $V_R = 5\text{ V}$ ;  $\lambda = 930\text{ nm}$ ;  $T_{amb} = 25\text{ }^{\circ}\text{C}$ .



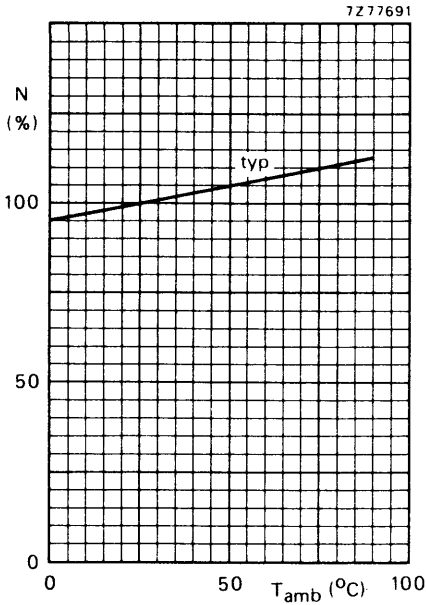

Fig. 9  $E_e = 1 \text{ mW/cm}^2$ ;  $\lambda = 930 \text{ nm}$ .

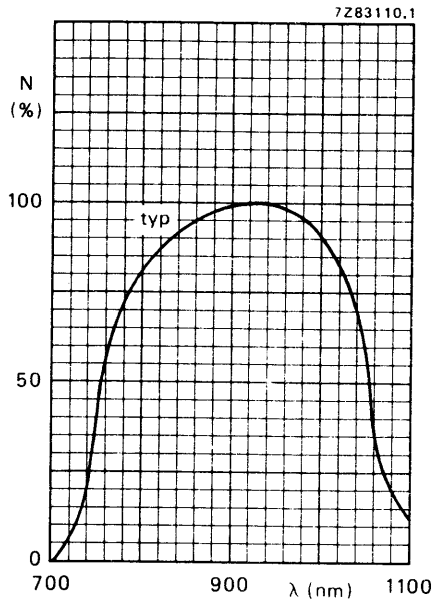

Fig. 10  $V_R = 5 \text{ V}$ ;  $T_{\text{amb}} = 25 \text{ }^\circ\text{C}$ .

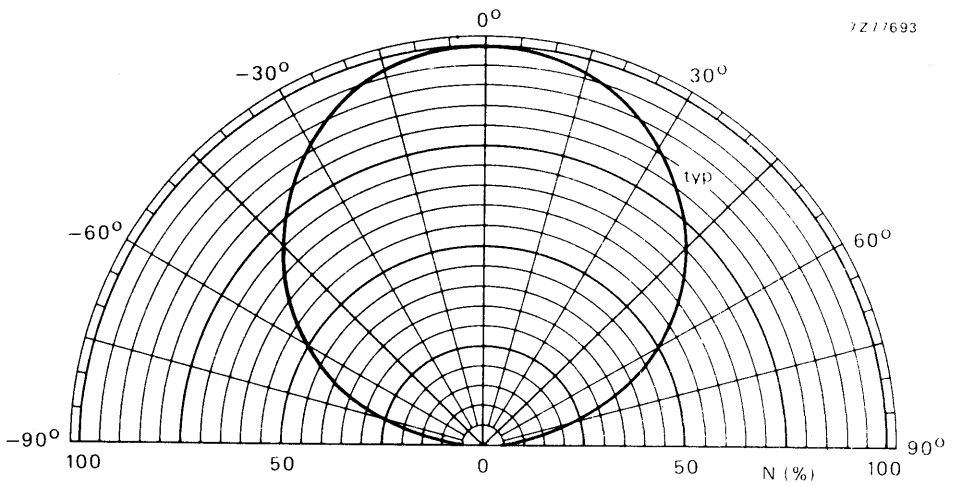

Fig. 11.





## SILICON N-P-N PHOTOTRANSISTORS

High sensitivity silicon planar n-p-n phototransistors for general purpose use. The BPX25 is lensed; the BPX29 has a plane window.

### QUICK REFERENCE DATA

Collector-emitter voltage (open base)	$V_{CE0}$	max.	32	V	
Collector current (peak value)	$I_{CM}$	max.	200	mA	
Junction temperature	$T_j$	max.	150	°C	
Collector dark current $I_B = 0; V_{CE} = 24\text{ V}$	$I_{CEO(D)}$	max.	500	nA	
Collector light current $I_B = 0; V_{CE} = 6\text{ V}; \text{ at } 1000\text{ lux}$	$I_{CEO(L)}$	BPX25 BPX29	typ. typ.	13 0.8	mA
Wavelength at peak response	$\lambda_{pk}$	typ.	750	nm	
Sensitive area			0.53 x 0.53	mm	

This data must be read in conjunction with GENERAL SAFETY RECOMMENDATIONS – OPTOELECTRONIC DEVICES

### MECHANICAL DATA

Dimensions in mm

Similar to J.E.D.E.C. TO-18, collector connected to case

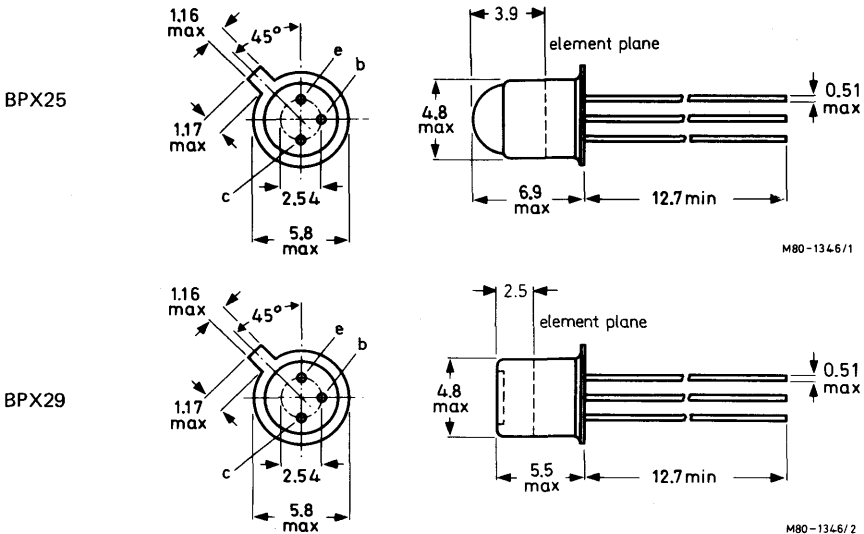

**RATINGS**

Limiting values in accordance with the Absolute Maximum System. (IEC134)

**Electrical**

Collector-base voltage (open emitter)	$V_{CBO}$	max.	32	V
Collector-emitter voltage (open base)	$V_{CEO}$	max.	32	V
Emitter-base voltage (open collector)	$V_{EBO}$	max.	5	V
Collector current (d.c.)	$I_C$	max.	100	mA
Collector current (peak)	$I_{CM}$	max.	200	mA
Total power dissipation ( $T_{amb} = 25\text{ }^\circ\text{C}$ )	$P_{tot}$	max.	300	mW

**Temperature**

Storage temperature range	$T_{stg}$		-65 to +150	$^\circ\text{C}$
Junction temperature (operating)	$T_j$	max.	150	$^\circ\text{C}$

**THERMAL CHARACTERISTICS**

From junction to ambient in free air	$R_{th(j-amb)}$		0.4	$^\circ\text{C}/\text{mW}$
From junction to case	$R_{th(j-case)}$		0.15	$^\circ\text{C}/\text{mW}$

**ELECTRICAL CHARACTERISTICS**

$T_{amb} = 25\text{ }^\circ\text{C}$  unless otherwise stated

		min.	typ.	max.		
Light current (tungsten lamp source) with open circuit base $V_{CE} = 6\text{ V}$ , at 1000 lux, colour temp. 2700 K (equivalent to $7.7\text{ mW}/\text{cm}^2$ )	$I_{CEO(L)}$	BPX25	5.0	15	—	mA
		BPX29	0.25	1.0	—	mA
Dark current, with open circuit base $V_{CE} = 24\text{ V}$	$I_{CEO(D)}$	—	40	500	nA	
$V_{CE} = 24\text{ V}$ , $T_{amb} = 100\text{ }^\circ\text{C}$	$I_{CEO(D)}$	—	7.0	100	$\mu\text{A}$	
Static forward current transfer ratio $V_{CE} = 6\text{ V}$ , $I_C = 2\text{ mA}$	$h_{FE}$	—	500	—		
Peak spectral response	$\lambda_{pk}$	—	750	—	nm	
Cut-off frequency, notes 1 & 2	$f_{co}$	BPX25	—	225	—	kHz
		BPX29	—	190	—	kHz





Switching characteristics

Delay time, notes 1 and 2

			min.	typ.	max.	
$t_d$	BPX25		—	0.9	3.0	$\mu s$
	BPX29		—	2.0	5.0	$\mu s$

Rise time, notes 1 and 2

$t_r$	BPX25		—	1.4	3.0	$\mu s$
	BPX29		—	2.5	5.0	$\mu s$

Storage time, note 1

$t_s$	BPX25		—	0.25	0.4	$\mu s$
	BPX29		—	0.4	0.6	$\mu s$

Fall time, notes 1 and 2

$t_f$	BPX25		—	1.6	4.0	$\mu s$
	BPX29		—	3.5	8.0	$\mu s$

Switching waveforms

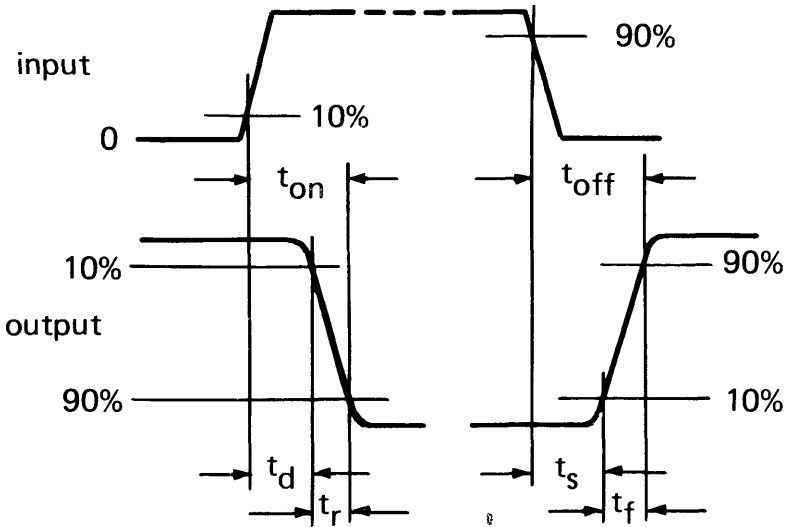

NOTES

1. Gallium arsenide lamp emitting modulated radiation at approximately  $0.4 \text{ mW/cm}^2$ , phototransistor used under optimum load conditions ( $50 \Omega$  load), at  $V_{CE} = 24 \text{ V}$ .
2. Improved switching times can be obtained by connecting the base lead to give a quiescent bias current. Typically at  $I_B = 2 \mu\text{A}$ ,  $t_d$  is reduced to  $< 0.2 \mu\text{s}$ .

SOLDERING AND WIRING RECOMMENDATIONS

1. The phototransistor may be soldered directly into a circuit but heat conducted to the junction should be kept to a minimum by the use of a thermal shunt.
2. Care should be taken not to bend the leads nearer than 1.5 mm from the seal.



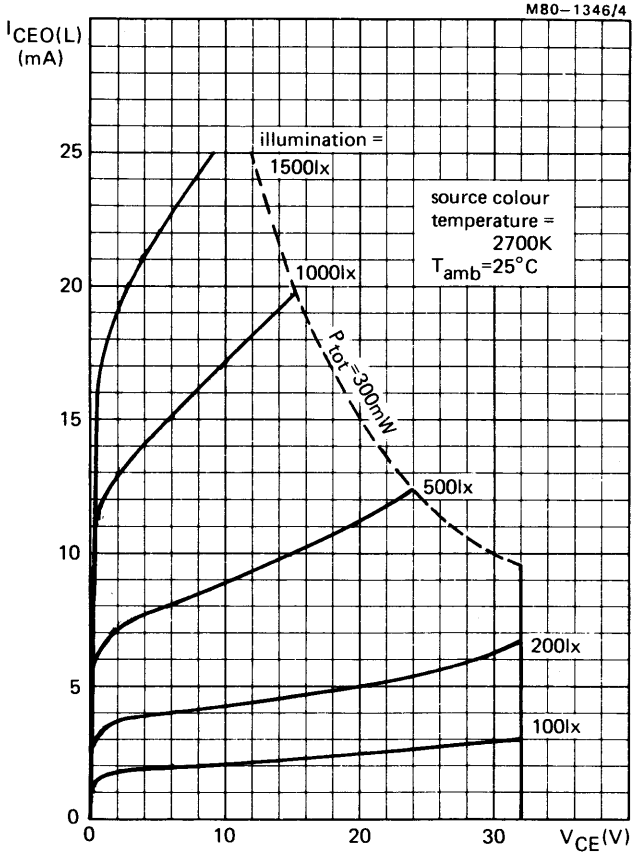

BPX25 Typical output characteristic



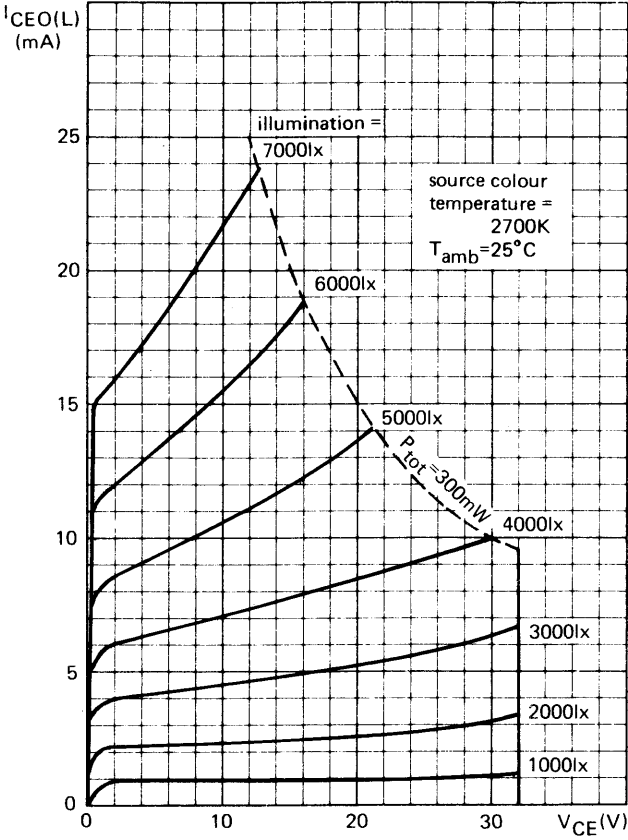

BPX29 Typical output characteristic



M80-1346/6

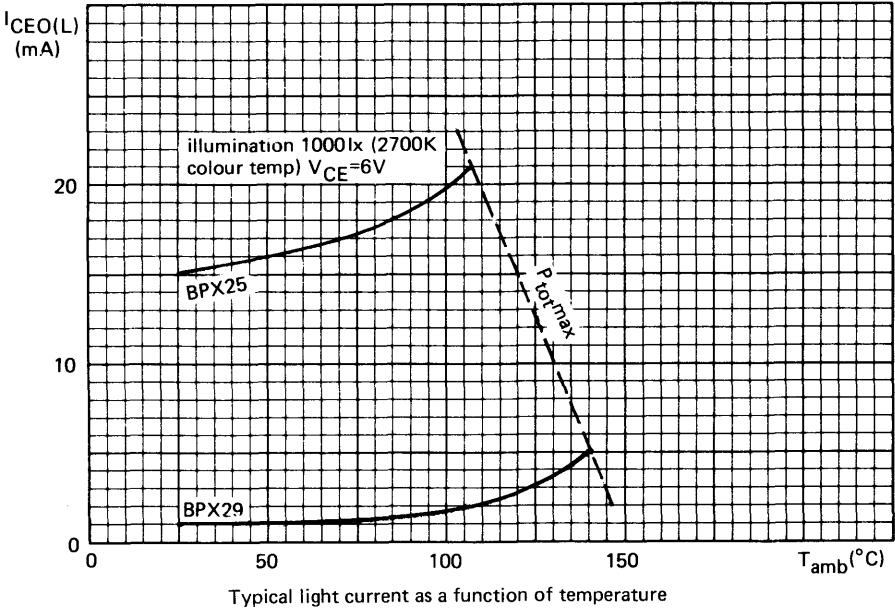

M80-1346/7

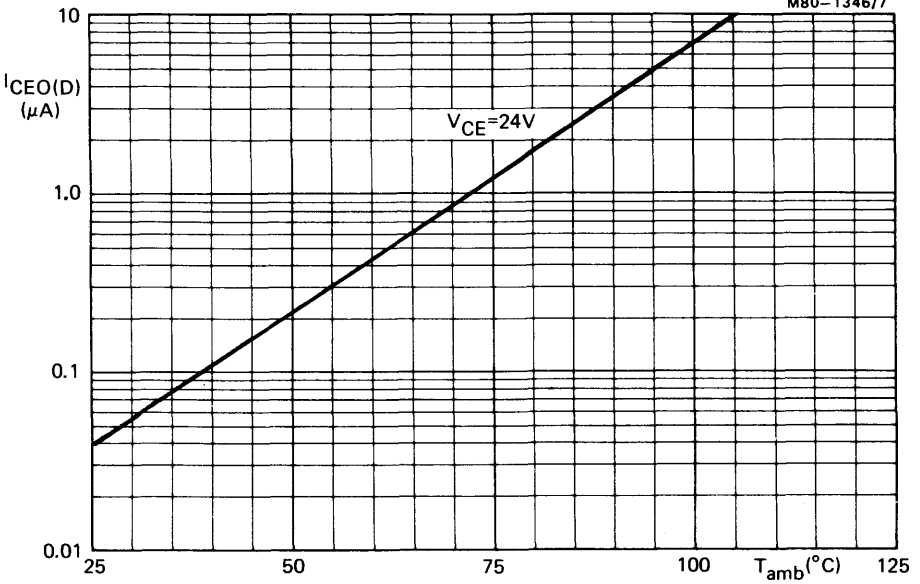

BPX25  
BPX29

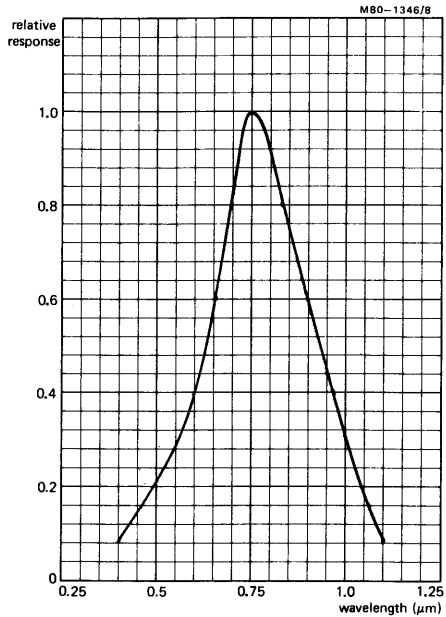

Typical spectral response

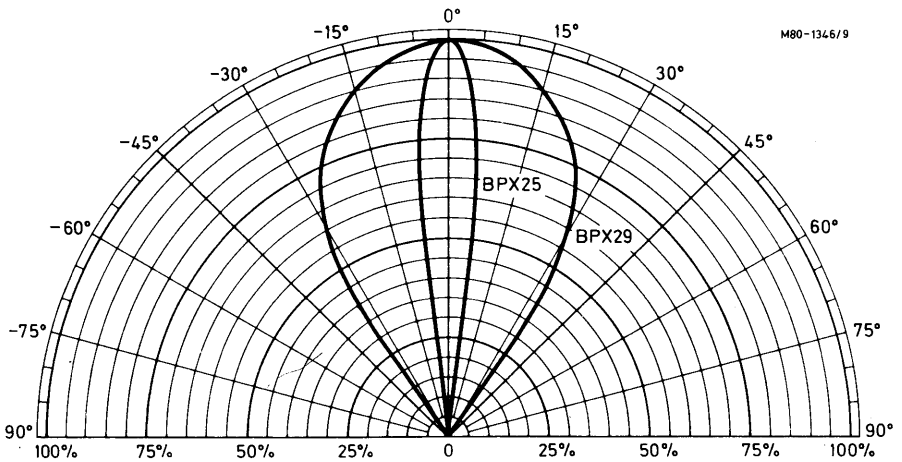

Typical polar diagram



## SILICON PLANAR EPITAXIAL PHOTOTRANSISTOR

N-P-N phototransistor designed for use as detector. Clear epoxy encapsulation.

### QUICK REFERENCE DATA

Collector-emitter voltage (open base)	$V_{CE0}$	max.	30 V
Collector current (d.c.)	$I_C$	max.	25 mA
Total power dissipation up to $T_{amb} = 25\text{ }^\circ\text{C}$	$P_{tot}$	max.	100 mW
Collector light (cut-off) current $V_{CE} = 5\text{ V}$ ; $E = 1\text{ mW/cm}^2$ ; $\lambda = 930\text{ nm}$	$I_{CE0(L)}$	>	3 mA
Wavelength at peak response	$\lambda_{pk}$	typ.	800 nm

This data must be read in conjunction with GENERAL SAFETY RECOMMENDATIONS – OPTOELECTRONIC DEVICES

### MECHANICAL DATA

Dimensions in mm

Fig. 1 SOD-63 (except distance between base and seating plane). (T-1%)

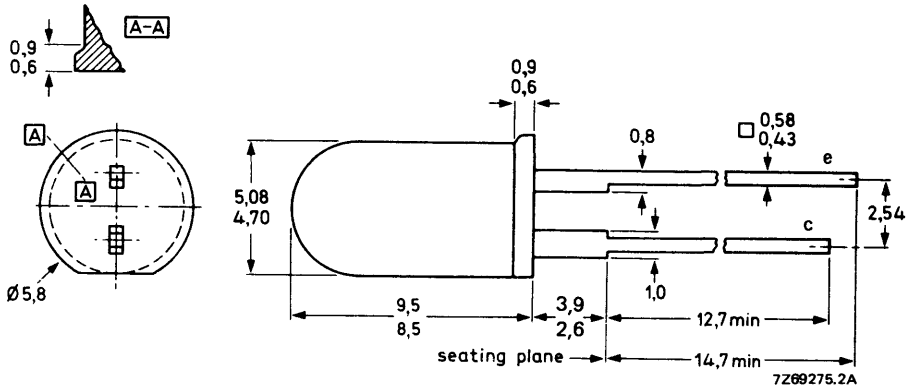

**RATINGS**

Limiting values in accordance with the Absolute Maximum System (IEC 134)

Collector-emitter voltage (open base)	$V_{CEO}$	max.	30 V
Emitter-collector voltage (open base)	$V_{ECO}$	max.	5 V
Collector current (d.c.)	$I_C$	max.	25 mA
Collector current (peak value) $t_p = 50 \mu s; \delta = 0,1$	$I_{CM}$	max.	50 mA
Total power dissipation up to $T_{amb} = 25 \text{ }^\circ\text{C}$	$P_{tot}$	max.	100 mW
Storage temperature	$T_{stg}$		-40 to +100 $^\circ\text{C}$
Junction temperature	$T_j$	max.	100 $^\circ\text{C}$
Lead soldering temperature up to the seating plane; $t_{sld} < 10 \text{ s}$	$T_{sld}$	max.	240 $^\circ\text{C}$

**THERMAL RESISTANCE**

From junction to ambient	$R_{th j-a}$	=	750 $^\circ\text{C/W}$
From junction to ambient, device mounted on a printed-circuit board	$R_{th j-a}$	=	500 $^\circ\text{C/W}$

**CHARACTERISTICS**

$T_j = 25 \text{ }^\circ\text{C}$  unless otherwise specified

Collector dark (cut-off) current $V_{CE} = 20 \text{ V}$	$I_{CEO(D)}$	<	100 nA
Collector light (cut-off) current* $V_{CE} = 5 \text{ V}; E = 1 \text{ mW/cm}^2; \lambda = 930 \text{ nm}$	$I_{CEO(L)}$	>	3 mA
Collector-emitter saturation voltage* $I_C = 2 \text{ mA}; E = 1 \text{ mW/cm}^2; \lambda = 930 \text{ nm}$	$V_{CEsat}$	<	0,4 V
Wavelength at peak response	$\lambda_{pk}$	typ.	800 nm
Bandwidth at half height	$B_{50\%}$	typ.	400 nm
Angle between half-sensitivity directions	$\alpha_{50\%}$	typ.	20 $^\circ$
Receiving area		typ.	1 mm $^2$

\* Measured with a tungsten linear filament lamp and an interference filter at  $\lambda = 930 \text{ nm}$ .





Switching times (see Figs 2, 3, 4 and 5)

$I_{Con} = 2 \text{ mA}$ ;  $V_{CC} = 5 \text{ V}$ ;  $R_E = 100 \Omega$ ;  $T_{amb} = 25 \text{ }^\circ\text{C}$

Light current turn-on time

Light current turn-off time

$t_{on}$  typ.  $3 \mu\text{s}$   
 $t_{off}$  typ.  $3 \mu\text{s}$

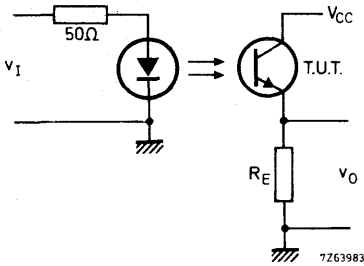

Fig. 2 Switching circuit.

Pulse generator:

$f = 500 \text{ Hz}$

$t_p = 20 \mu\text{s}$

$t_r = t_f = 20 \text{ ns}$

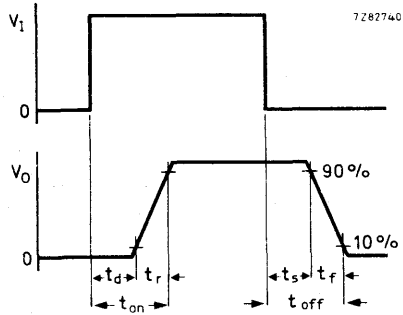

Fig. 3 Input and output switching waveforms.

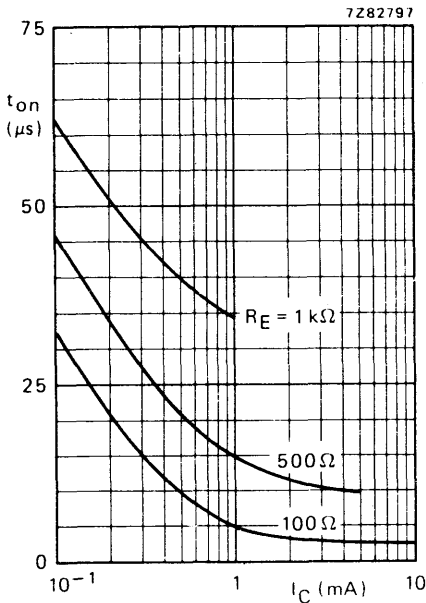

Fig. 4  $V_{CC} = 5 \text{ V}$ ;  $T_{amb} = 25 \text{ }^\circ\text{C}$ ; typ. values.

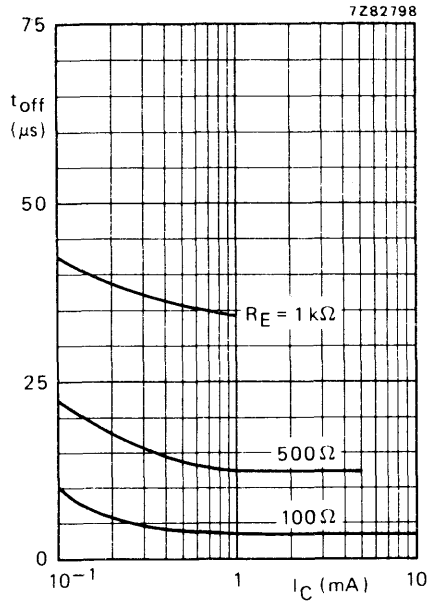

Fig. 5  $V_{CC} = 5 \text{ V}$ ;  $T_{amb} = 25 \text{ }^\circ\text{C}$ ; typ. values.



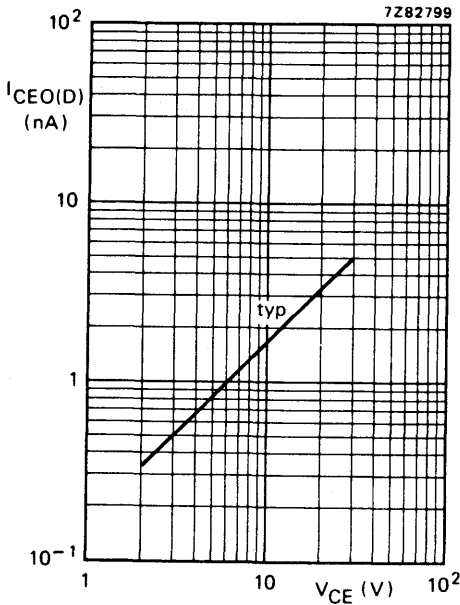

Fig. 6  $T_j = 25\text{ }^\circ\text{C}$ .

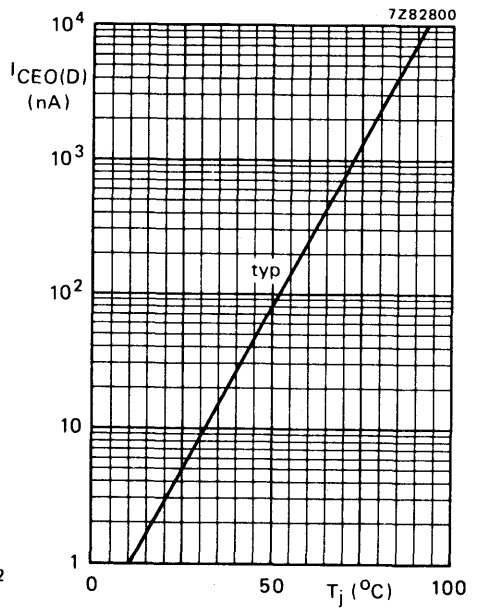

Fig. 7  $V_{CE} = 30\text{ V}$ .

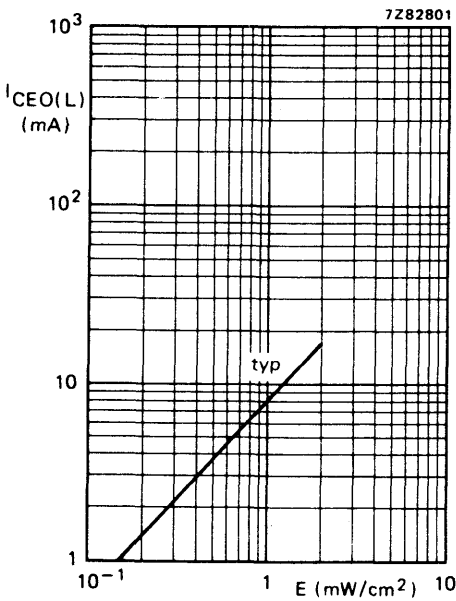

Fig. 8  $V_{CE} = 5\text{ V}$ ;  $\lambda = 930\text{ nm}$ ;  $T_j = 25\text{ }^\circ\text{C}$ .

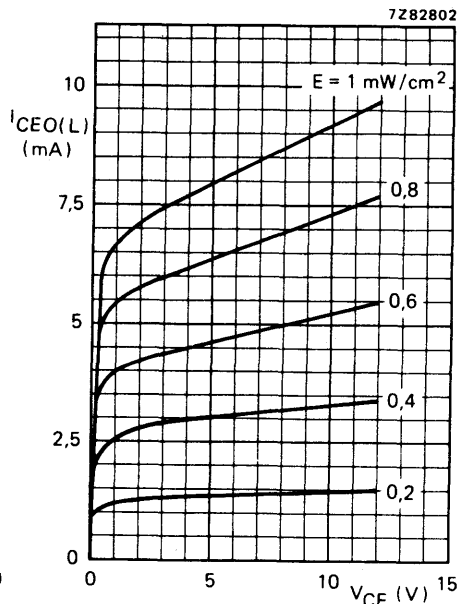

Fig. 9  $\lambda = 930\text{ nm}$ ;  $T_j = 25\text{ }^\circ\text{C}$ ; typ. values.



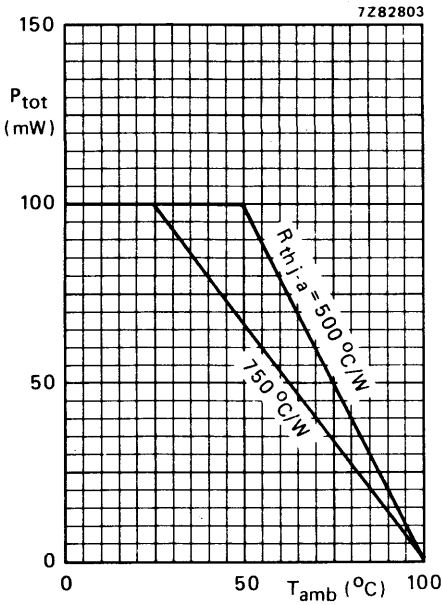

Fig. 10 Total power dissipation as a function of ambient temperature.

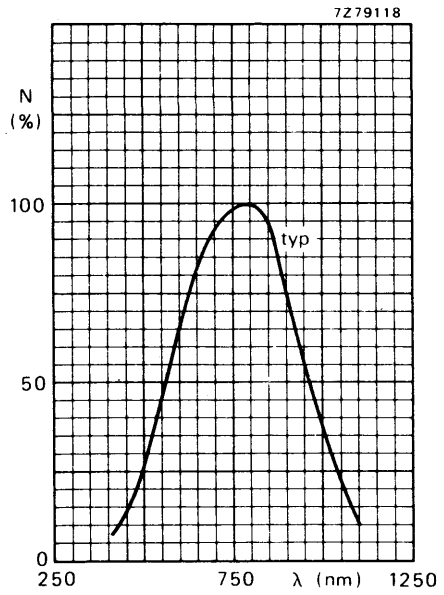

Fig. 11 Spectral response.

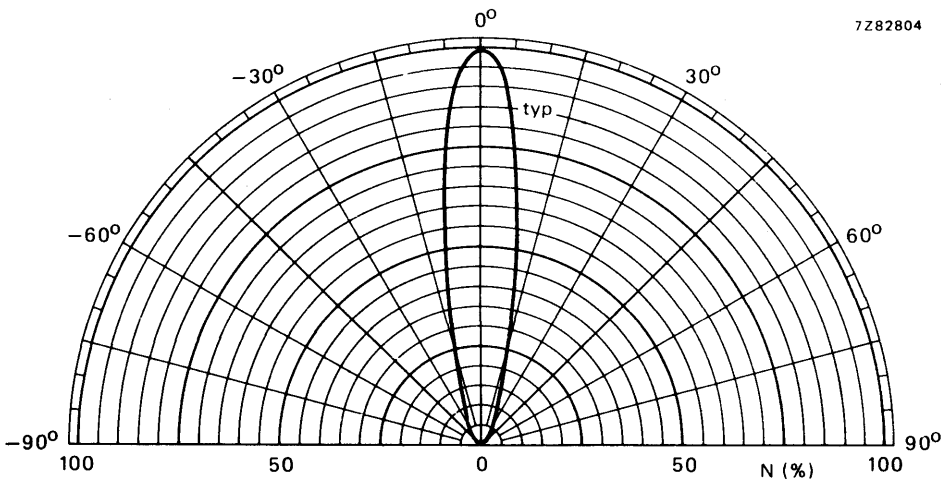

Fig. 12.





# LIGHT EMITTING DIODES

CQW10 to 12	CQY11B
CQX10	CQY11C
CQX11	CQY24B
CQX12	CQY49C
CQX51	CQY50,2
CQX54	CQY54
{ CQX55 to 58	CQY58A
{ CQX65 to 68	CQY89A
{ CQX75 to 78	CQY94
CQX64	CQY95
CQX74	CQY96
	CQY97

C





**C**

## GENERAL EXPLANATORY NOTES—LIGHT EMITTING DIODES

## INTRODUCTION

Light emitting diodes (LEDs) are current driven devices which emit coloured light from the junction region when forward biased. In the context of LED technology, light is assumed to include radiation from the visible to the near infrared regions of the spectrum, (up to  $3\ \mu\text{m}$ ). Planar techniques, similar to those adopted for the mass production of general purpose semiconductor devices, are used to manufacture LEDs from semiconductor materials such as gallium arsenide and gallium arsenide phosphide.

## BASIC CHARACTERISTICS OF LEDs

The most apparent property of LEDs is that when a current is passed through the device, it emits a coloured light depending on the composition used. Within certain limits, the higher the current, the brighter is the emitted light. For most applications a current of 5 to 20 mA is used and a voltage drop of approximately 1.7 to 2.1 V occurs across each device, depending on the composition used and therefore its colour of emission.

An LED's characteristic curve is similar to that of an ordinary silicon diode with a low reverse voltage (normally 3 to 5 V), see Fig.1.

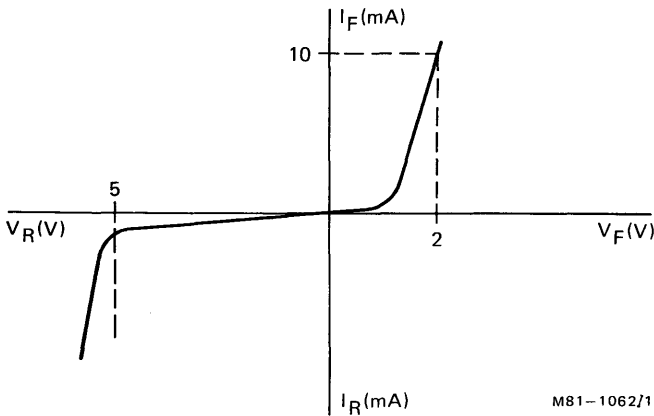

Fig.1

DRIVING CIRCUITS

1. D.C. drive using a series resistor

It is normally necessary to limit the current through the LED. A simple method is by means of a series resistor to set the forward current ( $I_F$ ) to the required level (typically about 10 mA for yellow, green and super-red LEDs and about 20 mA for standard red LEDs).

Calculations

To determine the value of the series limiting resistor, subtract the forward voltage drop of the LED, at the required forward current, from the supply voltage ( $V_B$ ) and divide this difference by the forward current.

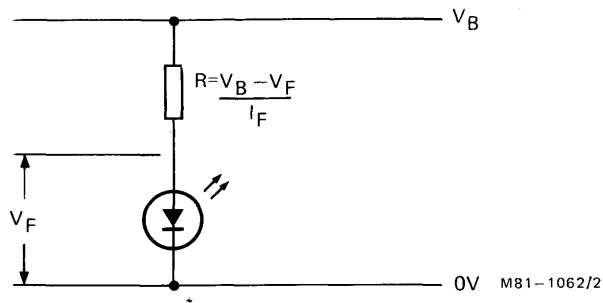

Fig.2

Example: CQY24B

- For  $V_B = 9\text{ V}$
- $I_F = 20\text{ mA}$
- $V_F = 2\text{ V max.}$
- $= 1.7\text{ V typ.}$

For 2 V max.  $V_F, R = \frac{9 - 2}{20 \cdot 10^{-3}} = 350\ \Omega$

For 1.7 V typ.  $V_F, R = \frac{9 - 1.7}{20 \cdot 10^{-3}} = 365\ \Omega$

However, the nearest 10% tolerance range resistors are  $330\ \Omega$  and  $390\ \Omega$ , which will give current levels of 22.1 mA and 18.7 mA respectively. These current levels give corresponding brightness levels of approximately 1.7 mcd and 1.2 mcd.

The human eye cannot detect a difference in brightness if the light output level is varied by less than a factor of approximately 2.5. As the factor in the above example is only 1.3,

( $\frac{1.7}{1.3} \approx 1.3$ ), it is prudent to select the lower current and brightness level in order to maximize the life of the LED and minimize the current consumption.





Light emitting diodes

2. A.C. drive from a mains supply

Another method is to drive the LED direct from an a.c. mains supply via a suitable series resistor. The LED must be protected from the peak reverse voltage during the negative phase of the a.c. cycle. This may be done by providing a by-pass in the form of a diode, as shown in Fig.3.

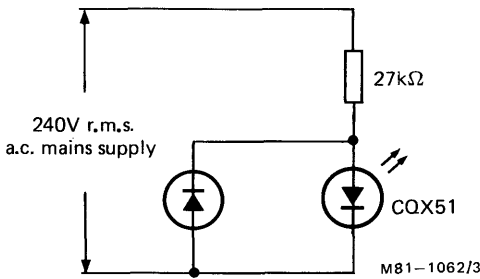

Fig.3

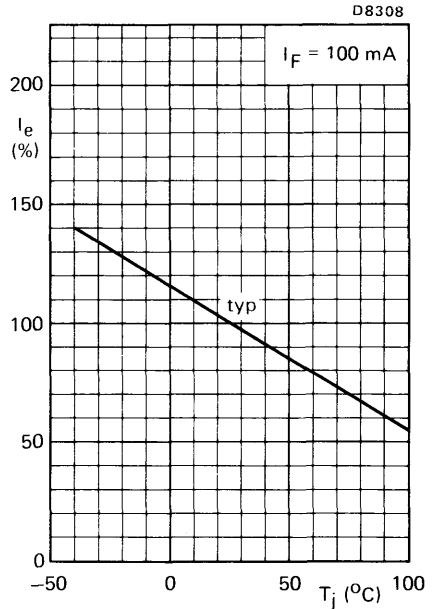

Fig.4

The comments made in the previous section regarding brightness levels are equally applicable to a.c. drive methods.

3. Pulsed operation

LEDs may be used in pulsed conditions where they can pass higher peak forward currents than in the d.c. condition, thus giving the possibility of higher peak light outputs.

A typical application of an LED under pulsed conditions is in the remote control unit of a TV receiver. In such a system, an IR-emitting LED transmits instructions to TV receiver via a photodiode detector. The peak LED output and operating range can be increased without increasing the junction temperature significantly by pulsing the information and reducing the average forward current.

Using the CQY89A near-infrared LED as an example, the peak forward current  $I_{FM}$ , with a duty cycle of 0.01, is approximately 1300 mA. This gives an output of 400 mW/sr at an ambient temperature of  $25^{\circ}\text{C}$ . If the pulse duration  $t_p$  is increased the average current and junction temperature rise. However, the junction temperature of the LED must not exceed  $100^{\circ}\text{C}$ . This limit is dictated by the progressive fall in radiation output as the junction temperature rises, as shown in Fig.4.



As the pulse duration  $t_p$  is increased, the cooling period ( $T - t_p$ ) falls. Therefore the permissible peak current also falls. As the duty cycle  $\delta$  becomes smaller, higher peak forward currents are possible, since the cooling period is extended. When the duty cycle  $\delta$  falls below 0.01, the drive current can be considered as single pulses instead of a coherent waveform and the heating effect on the output is only a function of  $t_p$ , indicated in Fig.5 by the curve  $\delta = 0$ .

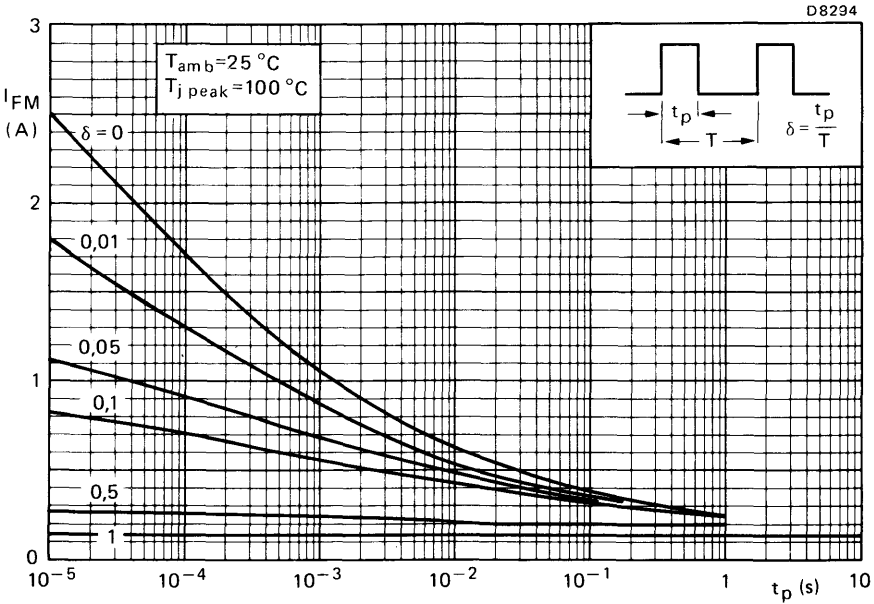

Fig.5  $T_{amb} = 25\text{ }^{\circ}\text{C}$ ;  $T_{j\text{ peak}} = 100\text{ }^{\circ}\text{C}$

**Calculation of radiation output from an LED in free-air**

For a given continuous forward current, the published data for an LED will give a value for the typical light output. However, this would normally only apply for a given junction temperature, say 25 °C. In practice, the forward current in the device increases the junction temperature and results in a decrease in output power. This is illustrated by the following example:

At a continuous forward current of 100 mA, published data for the CQY89A indicates that the typical output is 15 mW/sr. The LED has a thermal resistance  $R_{th}$  of 0.35 °C/mW. If the initial assumption is made that the forward power dissipated  $P_F$  is given by:

$$P_F = I_F V_F,$$

then Fig.6 can be used to estimate the power dissipated. The forward voltage  $V_F$ , at a junction temperature of 50 °C and an  $I_F$  of 100 mA, is 1.35 V, giving a forward power dissipation of 135 mW. When the ambient temperature is 25 °C, the junction temperature is:

$$T_j = 25 + (P_F \times R_{th\ j-a}),$$

$$T_j = (25 + 135 \times 0.35)$$

$$T_j = 72.2\text{ }^{\circ}\text{C}$$

that is,



The estimated  $V_F$  is now revised (from Fig.6) to give a value of 1.33 V. The reduced power in the device heats the junction to a lower temperature, slightly raising  $V_F$ . This calculated indicates that at 100 mA forward current the junction temperature is 72 °C. Fig.4 indicates that at 72 °C the output has fallen to 72 per cent of its value at 25 °C. Thus in this example the actual output for the LED in free air at a forward current of 100 mA is (15 x 0.72) mW/sr or 10.8 mW/sr.

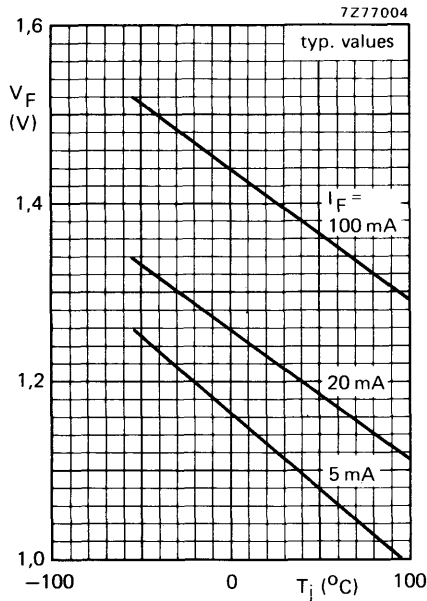

Fig.6

### Luminous intensity groups

The full spread of luminous intensity for light emitting diodes is too large for those applications where a number of devices are in close proximity to each other, i.e. bar graphs and high density displays. It is therefore desirable in such applications to limit the spread of luminous intensity to a level ( $< 2.5 \times$ ) so that it may not be detected by the human eye.

The data sheets will indicate, where appropriate, by means of suffixes the levels of luminous intensity into which our production is normally grouped.

The total spread of luminous intensity for light emitting materials is large (a factor of 10 x is not uncommon), yet within individual production batches it may be much less. This means that, over a period of time, some of the selections of radiant intensity may not be available. It is prudent, therefore, for those applications requiring a reduced spread of luminous intensity, to specify at least two adjacent selections. When ordering, please indicate all the selections which are acceptable. Users not requiring a reduced spread of luminous intensity should order the basic type number, without a suffix, thus indicating their acceptance of the total product.

Before ordering, it may be advisable to discuss a particular application with our engineers.







**RATINGS**

Limiting values in accordance with the Absolute Maximum System (IEC 134)

Continuous reverse voltage	$V_R$	max.	5 V
Forward current			
d.c.	$I_F$	max.	20 mA
peak value; $t_p = 1$ ms; $f = 300$ Hz	$I_{FM}$	max.	60 mA
peak value; $t_p = 1$ $\mu$ s; $\delta = 0,033$	$I_{FM}$	max.	1000 mA
Total power dissipation up to $T_{amb} = 55$ °C	$P_{tot}$	max.	60 mW
Storage temperature	$T_{stg}$	max.	100 °C
Junction temperature	$T_j$		-55 to + 100 °C
Lead soldering temperature			
up to 1,5 mm of the seating plane; $t_{sld} < 7$ s	$T_{sld}$	max.	230 °C

**THERMAL RESISTANCE**

From junction to ambient in free air	$R_{thj-a}$	=	750 °C/W
--------------------------------------	-------------	---	----------

**CHARACTERISTICS**

$T_j = 25$  °C

Forward voltage			
$I_F = 10$ mA	$V_F$	typ.	2,1 V
		<	3 V
Reverse current			
$V_R = 5$ V	$I_R$	<	100 $\mu$ A
Diode capacitance			
$V_R = 0$ ; $f = 1$ MHz	$C_d$	typ.	35 pF
Luminous intensity (on-axis)			
$I_F = 10$ mA	$I_v$	>	0,5 mcd
		typ.	1,5 mcd
Wavelength at peak emission			
	<b>CQW10</b>	$\lambda_{pk}$	typ. 630 nm
	<b>CQW11</b>	$\lambda_{pk}$	typ. 560 nm
	<b>CQW12</b>	$\lambda_{pk}$	typ. 590 nm
Beamwidth between half-intensity directions		$\alpha_{50\%}$	typ. 100°



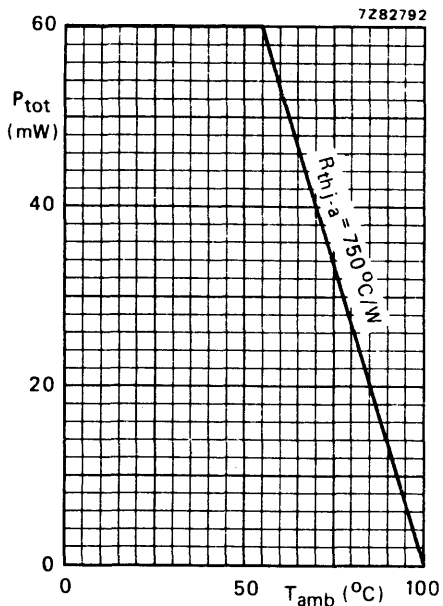

Fig. 2 Maximum permissible total power dissipation versus ambient temperature.

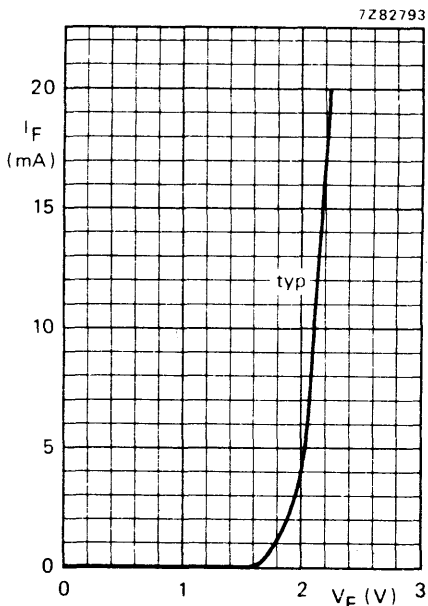

Fig. 3  $T_j = 25^{\circ}C$ .

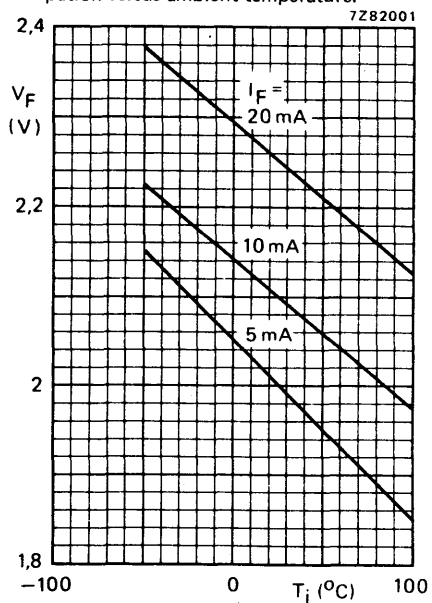

Fig. 4 Typical values.

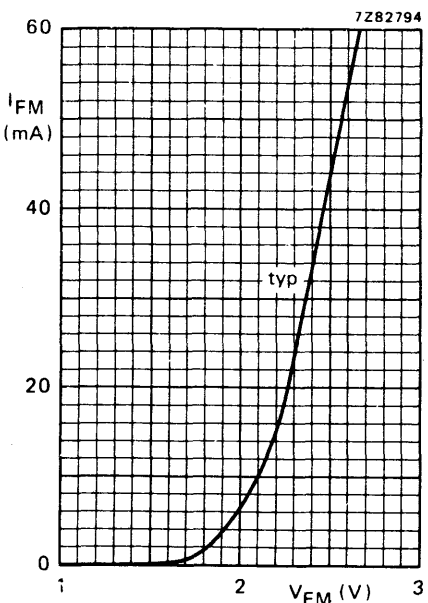

Fig. 5  $t_p = 50 \mu s$ ;  $T = 5\text{ ms}$ ;  $T_j = 25^{\circ}C$ .



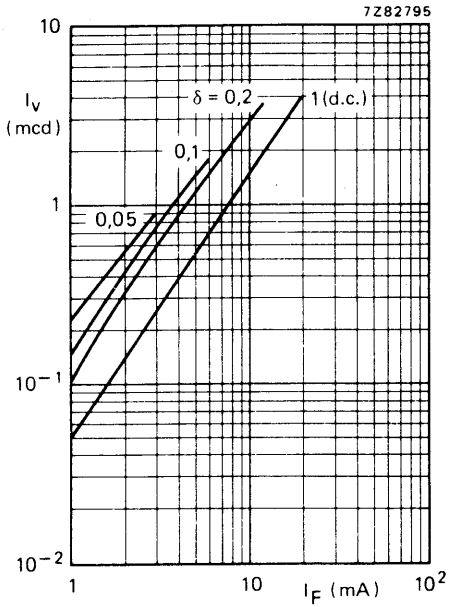

Fig. 6 Typical values;  $T_j = 25\text{ }^\circ\text{C}$ .

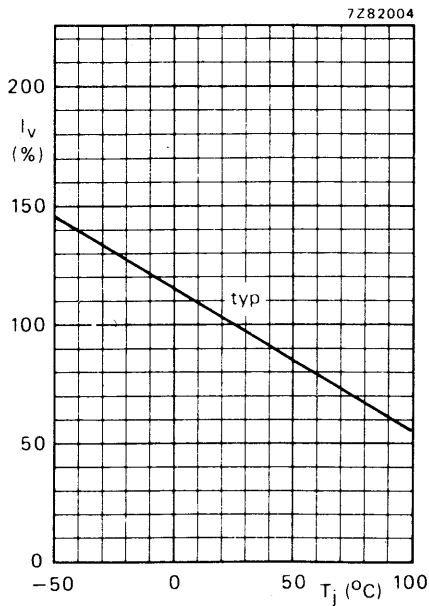

Fig. 7  $I_F = 10\text{ mA}$ .





7Z82005

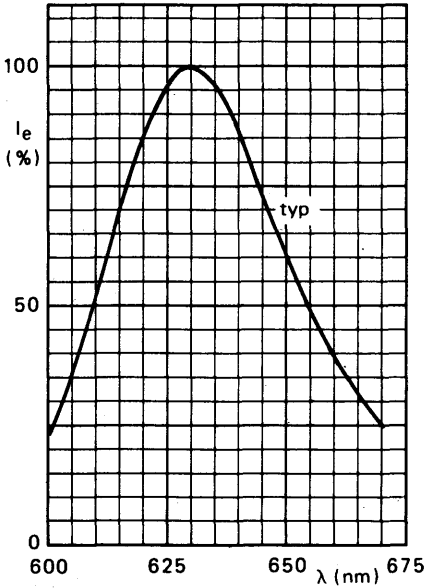

Fig. 8 CQW10.

7Z82006

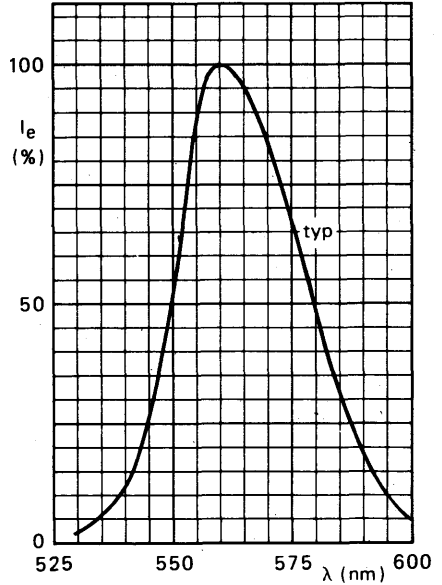

Fig. 9 CQW11.

7Z82007

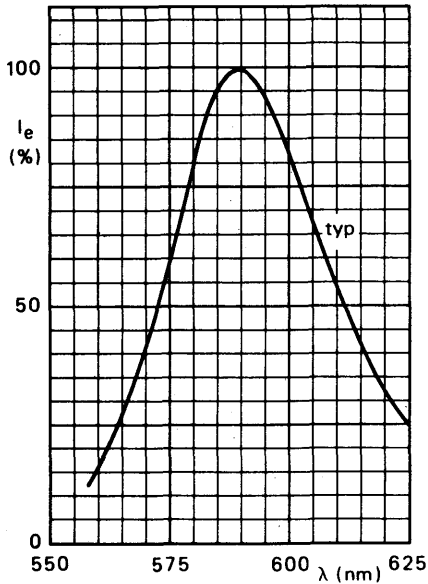
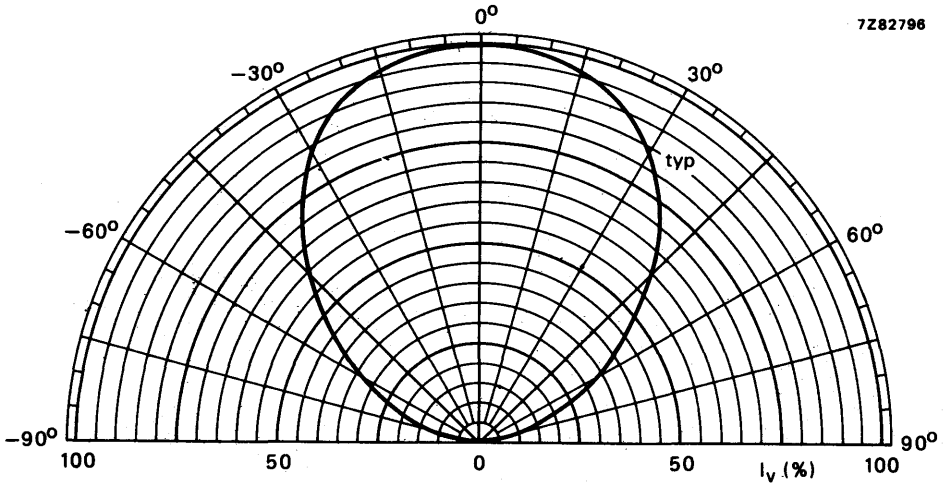

Fig. 10 CQW12.





## STACKABLE SUPER-RED LIGHT EMITTING DIODE

Gallium arsenide phosphide light emitting diode which emits super-red light when forward biased.  
Supplied in flat plastic package suitable for stacking

### QUICK REFERENCE DATA

Continuous reverse voltage	$V_R$	max.	5	V
Forward current (d.c.)	$I_F$	max.	30	mA
Total power dissipation up to $T_{amb} = 25\text{ }^\circ\text{C}$	$P_{tot}$	max.	120	mW
Luminous intensity at $I_F = 10\text{ mA}$	$I_v$	min.	0.7	mcd
	$I_v$	typ.	1.0	mcd
Wavelength at peak emission	$\lambda_{pk}$	typ.	630	nm
Beamwidth between half intensity directions, in the plane of the connections	$\theta_{50\%}$	typ.	50	degrees
in the plane perpendicular to the connections	$\theta_{50\%}$	typ.	40	degrees
Thermal resistance from junction to ambient	$R_{th\ j-a}$	max.	0.625	$^\circ\text{C}/\text{mW}$

This data must be read in conjunction with GENERAL SAFETY RECOMMENDATIONS – OPTOELECTRONIC DEVICES

### PRODUCT SAFETY

Modern high technology materials have been used in the manufacture of this device to ensure high performance. Some of these materials are toxic in certain circumstances. Mechanical or electrical damage is unlikely to give rise to any hazard, but toxic vapours may be generated if the device is heated to destruction. Disposal of large quantities should therefore be carried out in accordance with the Deposit of Poisonous Waste Act 1972 and the Control of Pollution Act 1974, or with the latest legislation.

### MECHANICAL DATA

Dimensions in mm

SOD-65

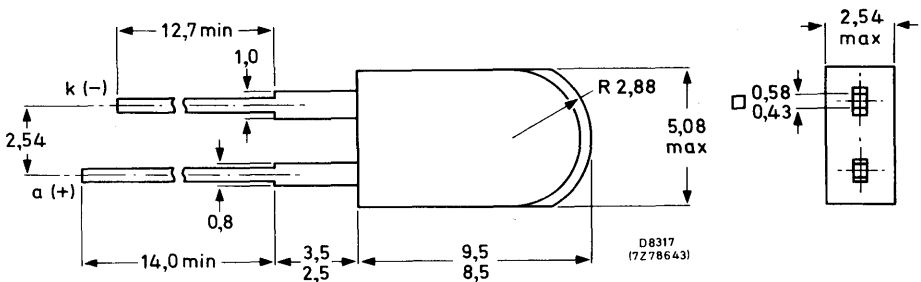

## RATINGS

Limiting values in accordance with the Absolute Maximum System (IEC 134)

Continuous reverse voltage	$V_R$	max.	5 V
Forward current (d.c.)	$I_F$	max.	30 mA
Forward current (peak value)			
$t_p = 10 \mu\text{s}$ , non-repetitive	$I_{FSM}$	max.	1000 mA
Power dissipation up to $T_{amb} = 25^\circ\text{C}$	$P_{tot}$	max.	120 mW
Storage temperature	$T_{stg}$		-55 to +100 °C
Junction temperature	$T_j$	max.	100 °C
Soldering temperature, up to the seating plane,			
$t_{sld} < 10 \text{ s}$	$T_{sld}$	max.	260 °C

## THERMAL RESISTANCE

From junction to ambient	$R_{th j-a}$	max.	0.625 °C/mW
From junction to ambient, device mounted on a printed circuit board	$R_{th j-a}$	max.	0.5 °C/mW

## CHARACTERISTICS

 $T_j = 25^\circ\text{C}$ 

Forward voltage

$I_F = 10 \text{ mA}$	$V_F$	typ.	2.1 V
		<	3.0 V

Reverse current

$V_R = 3 \text{ V}$	$I_R$	<	100 $\mu\text{A}$
---------------------	-------	---	-------------------

Diode capacitance

$V_R = 0$ , $f = 1 \text{ MHz}$	$C_d$	typ.	35 pF
---------------------------------	-------	------	-------

Luminous intensity \*

$I_F = 10 \text{ mA}$ , CQX10	$I_v$	>	0.5 mcd
CQX10-I	$I_v$		0.7 to 1.6 mcd
CQX10-II	$I_v$		1.0 to 2.2 mcd
CQX10-III	$I_v$		1.6 to 3.5 mcd
CQX10-IV	$I_v$	>	3.0 mcd

Wavelength at peak emission

$\lambda_{pk}$	typ.	630 nm
----------------	------	--------

Beamwidth between half intensity directions

in the plane of the connections	$\theta_{50\%}$	typ.	50 degrees
in the plane perpendicular to the connections	$\theta_{50\%}$	typ.	40 degrees

\* For applications using a number of devices in close proximity, thus requiring spreads of luminous intensity of less than 2.5 times, production is graded into groups indicated by suffixes. Specific groupings, subject to availability, may be obtained only by negotiation with the supplier.



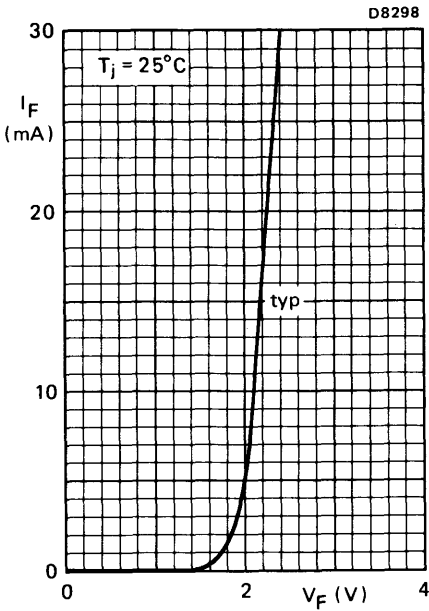

Fig.1

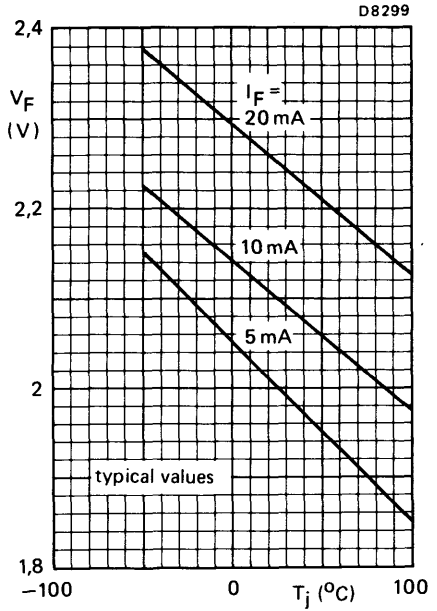

Fig.2



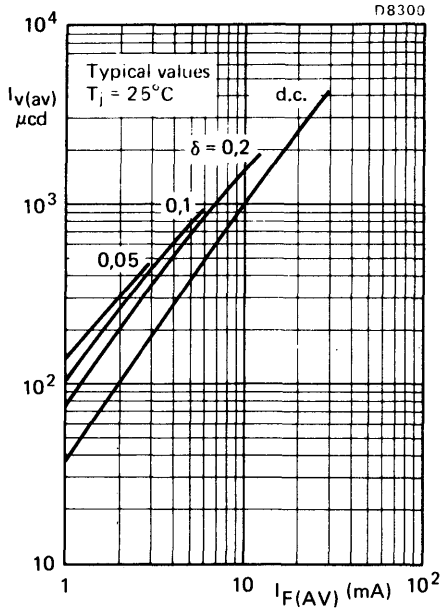

Fig.3

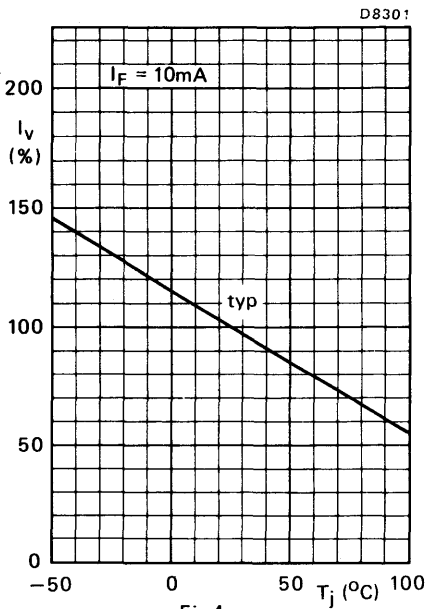

Fig.4

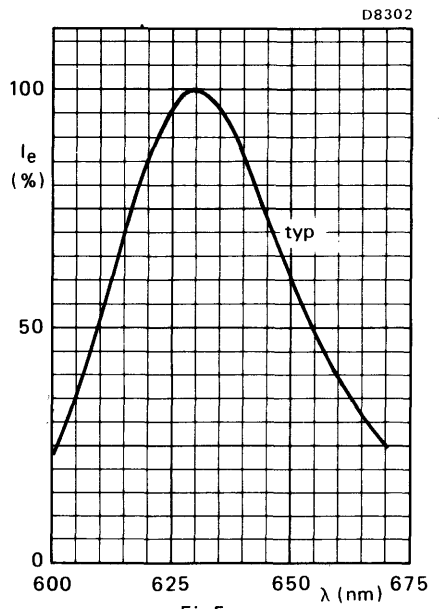
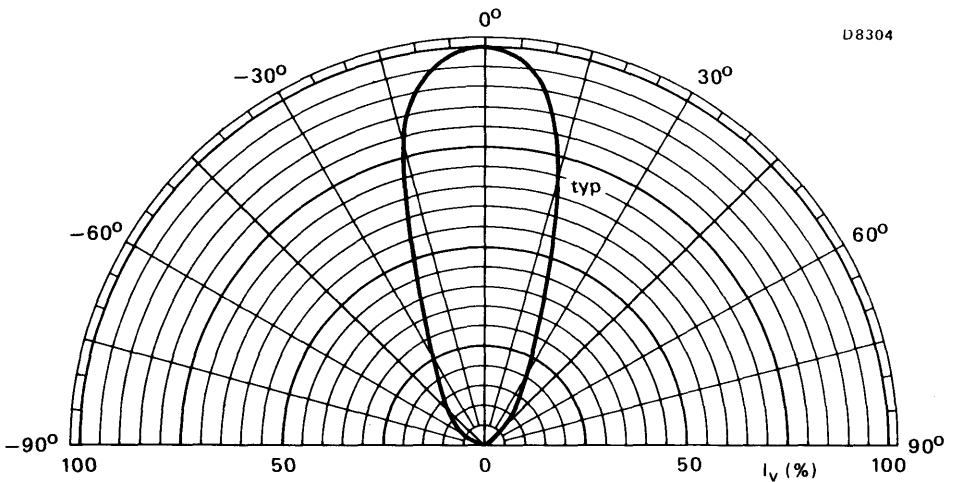
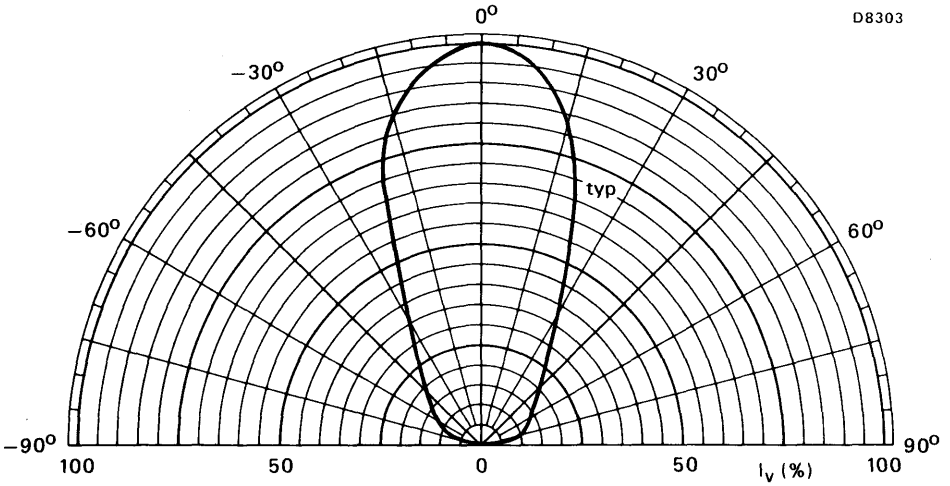

Fig.5









## STACKABLE GREEN LIGHT EMITTING DIODE

Gallium phosphide light emitting diode which emits green light when forward biased. Supplied in flat plastic package suitable for stacking.

### QUICK REFERENCE DATA

Continuous reverse voltage	$V_R$	max.	5	V
Forward current (d.c.)	$I_F$	max.	30	mA
Total power dissipation up to $T_{amb} = 25\text{ }^\circ\text{C}$	$P_{tot}$	max.	120	mW
Luminous intensity at $I_F = 10\text{ mA}$	$I_v$	min.	0.7	mcd
	$I_v$	typ.	1.0	mcd
Wavelength at peak emission	$\lambda_{pk}$	typ.	560	nm
Beamwidth between half intensity directions, in the plane of the connections	$\theta_{50\%}$	typ.	50	degrees
	$\theta_{50\%}$	typ.	40	degrees
Thermal resistance from junction to ambient	$R_{th\ j-a}$	max.	0.625	$^\circ\text{C}/\text{mW}$

This data must be read in conjunction with GENERAL SAFETY RECOMMENDATIONS – OPTOELECTRONIC DEVICES

### PRODUCT SAFETY

Modern high technology materials have been used in the manufacture of this device to ensure high performance. Some of these materials are toxic in certain circumstances. Mechanical or electrical damage is unlikely to give rise to any hazard, but toxic vapours may be generated if the device is heated to destruction. Disposal of large quantities should therefore be carried out in accordance with the Deposit of Poisonous Waste Act 1972 and the Control of Pollution Act 1974, or with the latest legislation.

### MECHANICAL DATA

Dimensions in mm

SOD-65

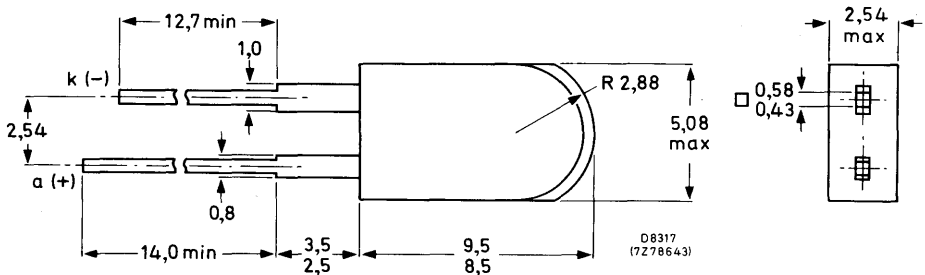



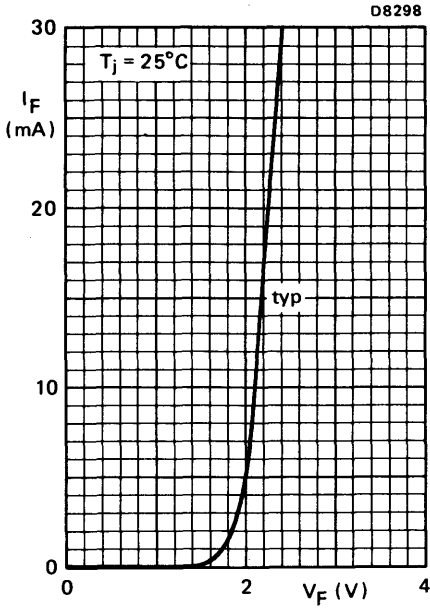

Fig.1

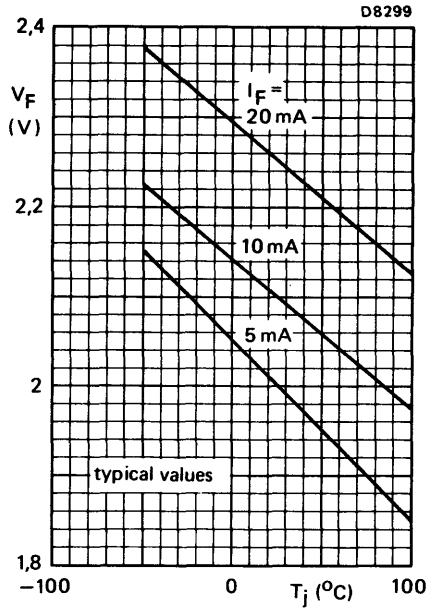

Fig.2



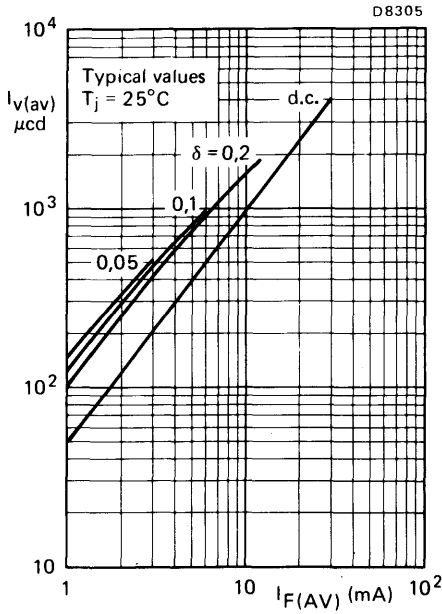

Fig.3

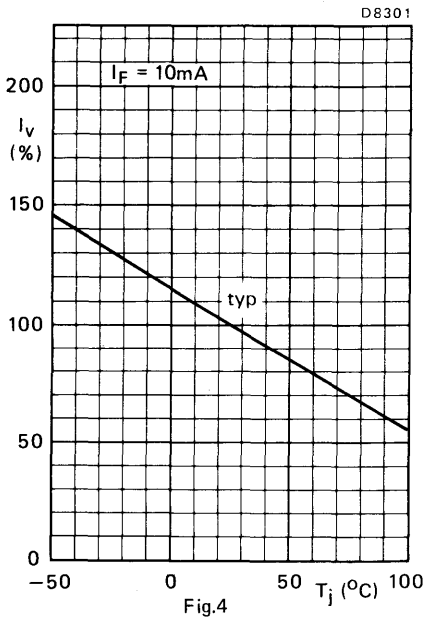

Fig.4

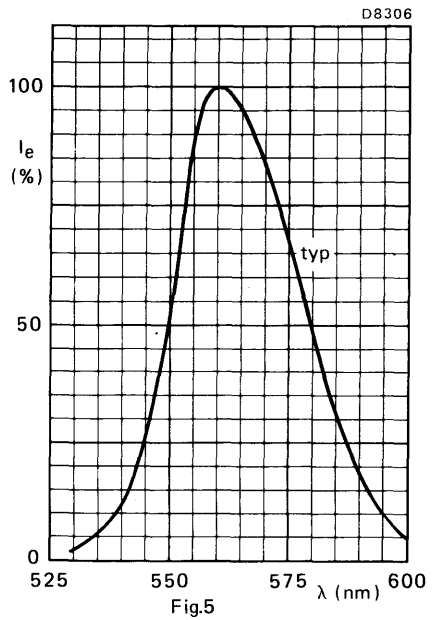

Fig.5



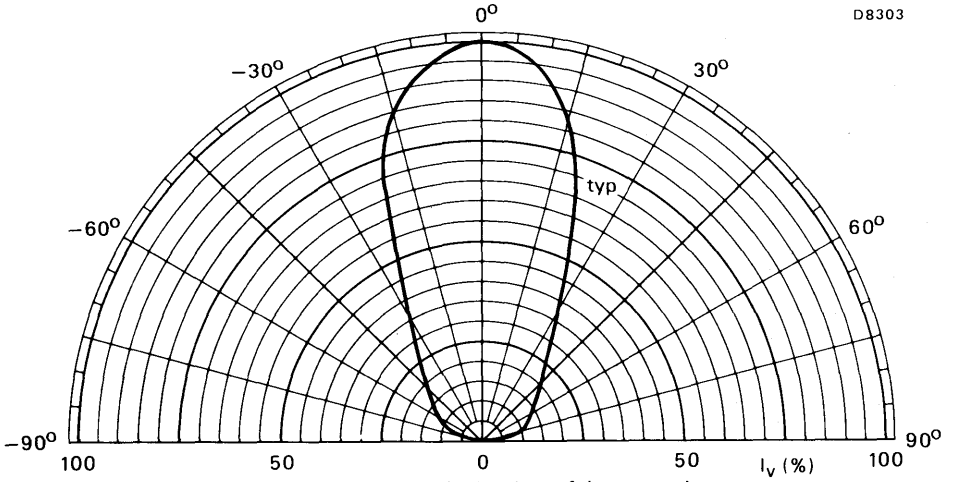

Fig. 6 Spatial distribution in the plane of the connections

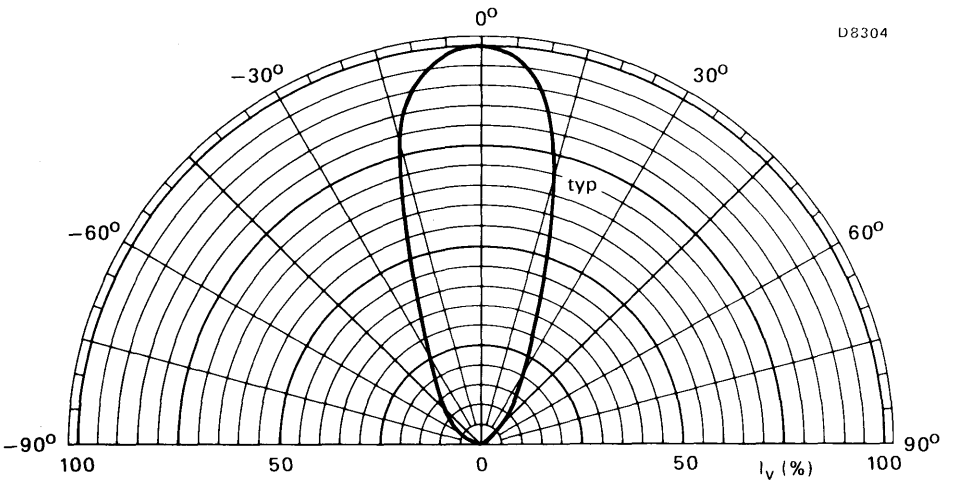

Fig. 7 Spatial distribution in the plane perpendicular to the connections





## STACKABLE YELLOW LIGHT EMITTING DIODE

Gallium arsenide phosphide light emitting diode which emits yellow light when forward biased.  
Supplied in flat plastic package suitable for stacking.

### QUICK REFERENCE DATA

Continuous reverse voltage	$V_R$	max.	5	V
Forward current (d.c.)	$I_F$	max.	30	mA
Total power dissipation up to $T_{amb} = 25\text{ }^\circ\text{C}$	$P_{tot}$	max.	120	mW
Luminous intensity at $I_F = 10\text{ mA}$	$I_v$	min.	0.7	mcd
	$I_v$	typ.	1.0	mcd
Wavelength at peak emission	$\lambda_{pk}$	typ.	590	nm
Beamwidth between half intensity directions, in the plane of the connections	$\theta_{50\%}$	typ.	50	degrees
	$\theta_{50\%}$	typ.	40	degrees
Thermal resistance from junction to ambient	$R_{th\ j-a}$	max.	0.625	$^\circ\text{C}/\text{mW}$

This data must be read in conjunction with GENERAL SAFETY RECOMMENDATIONS – OPTOELECTRONIC DEVICES

### PRODUCT SAFETY

Modern high technology materials have been used in the manufacture of this device to ensure high performance. Some of these materials are toxic in certain circumstances. Mechanical or electrical damage is unlikely to give rise to any hazard, but toxic vapours may be generated if the device is heated to destruction. Disposal of large quantities should therefore be carried out in accordance with the Deposit of Poisonous Waste Act 1972 and the Control of Pollution Act 1974, or with the latest legislation.

### MECHANICAL DATA

Dimensions in mm

SOD-65

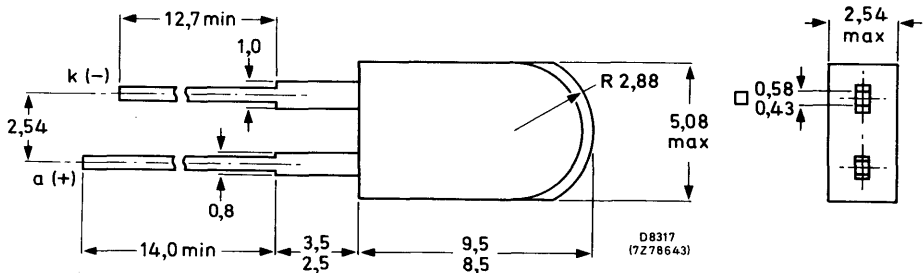

**RATINGS**

Limiting values in accordance with the Absolute Maximum System (IEC 134)

Continuous reverse voltage	$V_R$	max.	5	V
Forward current (d.c.)	$I_F$	max.	30	mA
Forward current (peak value) $t_p = 10 \mu s$ , non-repetitive	$I_{FSM}$	max.	1000	mA
Power dissipation up to $T_{amb} = 25^\circ C$	$P_{tot}$	max.	120	mW
Storage temperature	$T_{stg}$		-55 to +100	$^\circ C$
Junction temperature	$T_j$	max.	100	$^\circ C$
Soldering temperature, up to the seating plane $t_{sld} < 10 s$	$T_{sld}$	max.	260	$^\circ C$

**THERMAL RESISTANCE**

From junction to ambient	$R_{th j-a}$	max.	0.625	$^\circ C/mW$
From junction to ambient, device mounted on a printed circuit board	$R_{th j-a}$	max.	0.5	$^\circ C/mW$

**CHARACTERISTICS**

$T_j = 25^\circ C$

Forward voltage

$I_F = 10 mA$	$V_F$	typ. <	2.1 3.0	V V
---------------	-------	-----------	------------	--------

Reverse current

$V_R = 3 V$	$I_R$	<	100	$\mu A$
-------------	-------	---	-----	---------

Diode capacitance

$V_R = 0, f = 1 MHz$	$C_d$	typ.	35	pF
----------------------	-------	------	----	----

Luminous intensity \*

$I_F = 10 mA$	CQX12	$I_v$	>	0.5	mcd
	CQX12-I	$I_v$		0.7 to 1.6	mcd
	CQX12-II	$I_v$		1.0 to 2.2	mcd
	CQX12-III	$I_v$		1.6 to 3.5	mcd
	CQX12-IV	$I_v$	>	3.0	mcd

Wavelength at peak emission

$\lambda_{pk}$	typ.	590	nm
----------------	------	-----	----

Beamwidth between half intensity directions

in the plane of the connections	$\theta_{50\%}$	typ.	50	degrees
in the plane perpendicular to the connections	$\theta_{50\%}$	typ.	40	degrees

\*For applications using a number of devices in close proximity, thus requiring spreads of luminous intensity of less than 2.5 times, production is graded into groups indicated by suffixes. Specific groupings, subject to availability, may be obtained only by negotiation with the supplier.





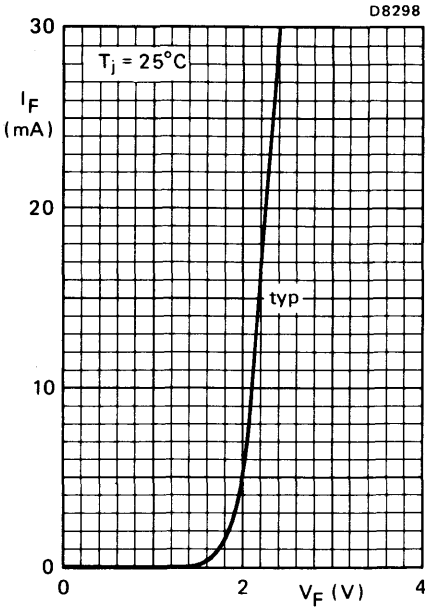

Fig.1

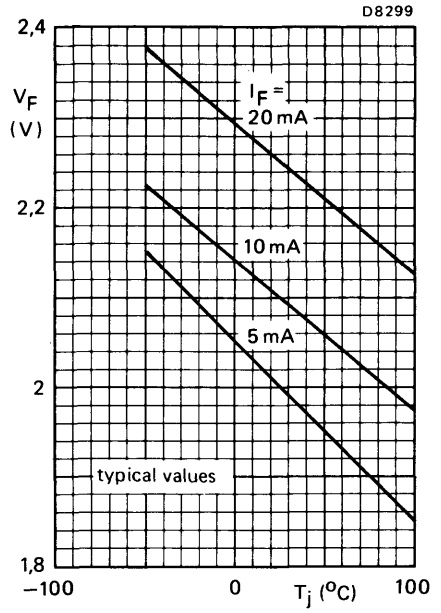

Fig.2



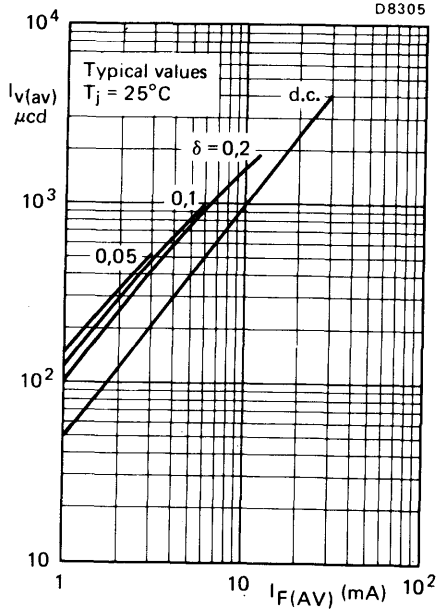

Fig.3

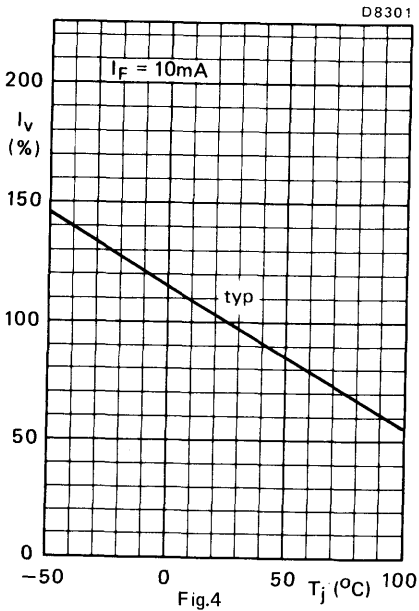

Fig.4

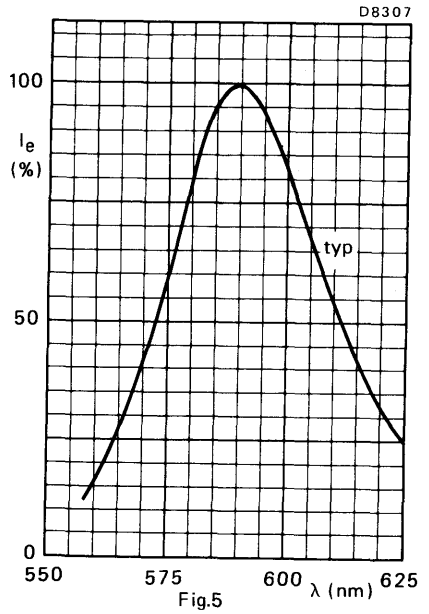

Fig.5



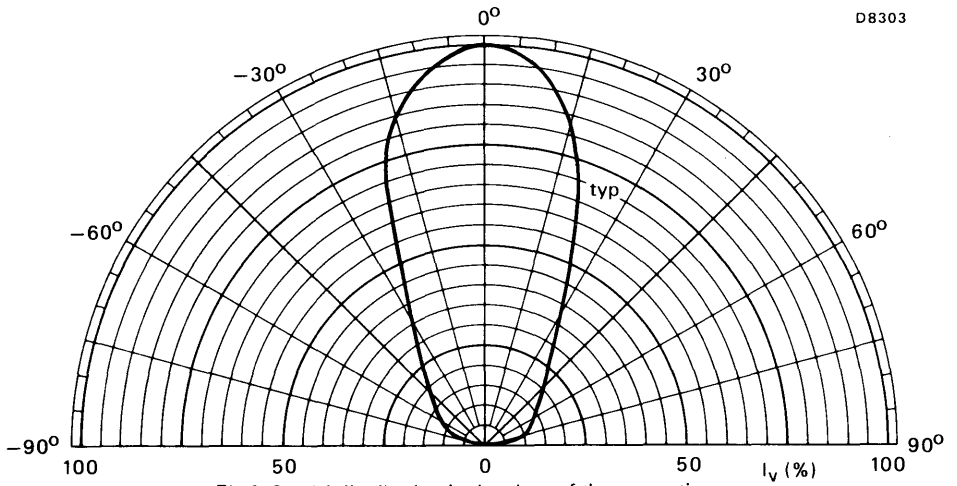

Fig.6 Spatial distribution in the plane of the connections

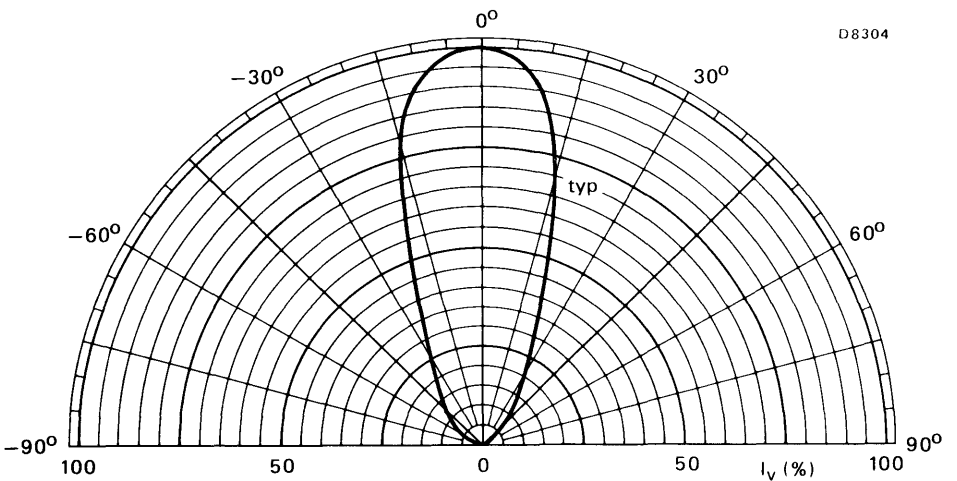

Fig.7 Spatial distribution in the plane perpendicular to the connections





## HIGH-EFFICIENCY GaAsP RED LIGHT EMITTING DIODE

Gallium arsenide phosphide light emitting diode which emits visible super-red light. Red, light-diffusing plastic envelope.

### QUICK REFERENCE DATA

Continuous reverse voltage	$V_R$	max.	3 V
Forward current (d.c.)	$I_F$	max.	20 mA
Total power dissipation up to $T_{amb} = 55\text{ }^\circ\text{C}$	$P_{tot}$	max.	60 mW
Luminous intensity (on-axis) at $I_F = 10\text{ mA}$	$I_v$	min.	1.6 mcd
		typ.	3.0 mcd
Wavelength at peak emission	$\lambda_{pk}$	typ.	630 nm
Beamwidth between half-intensity directions	$\alpha_{50\%}$	typ.	$55^\circ$

This data must be read in conjunction with GENERAL SAFETY RECOMMENDATIONS – OPTOELECTRONIC DEVICES

### PRODUCT SAFETY

Modern high technology materials have been used in the manufacture of this device to ensure high performance. Some of these materials are toxic in certain circumstances. Mechanical or electrical damage is unlikely to give rise to any hazard, but toxic vapours may be generated if the device is heated to destruction. Disposal of large quantities should therefore be carried out in accordance with the Deposit of Poisonous Waste Act 1972 and the Control of Pollution Act 1974, or with the latest legislation.

### MECHANICAL DATA

Dimensions in mm

Fig. 1 SOD-63 (T-1%)

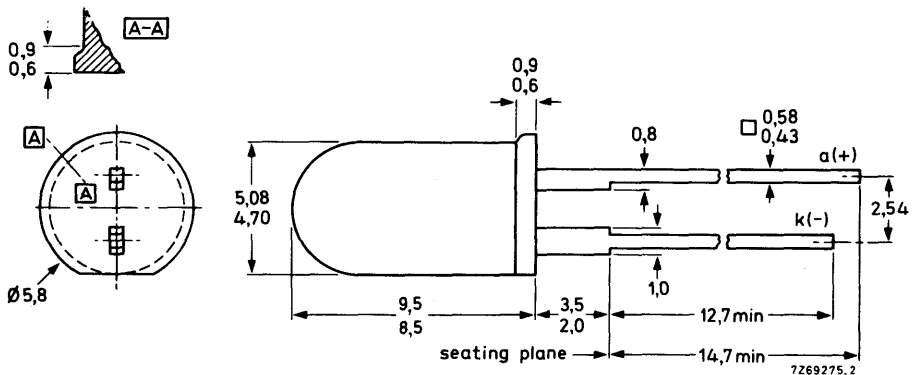

CQX51

Accessories for panel mounting (panel thickness < 4 mm)

Plastic clip and ring  
black type RTC757A

Hole diameter

6,4 mm for panel thickness < 3 mm

6,5 mm for panel thickness > 3 mm

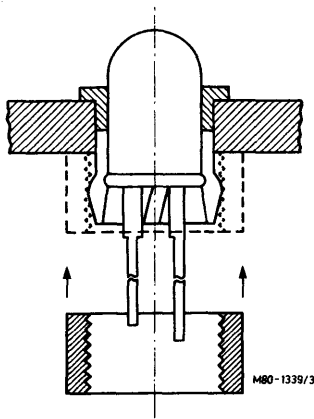
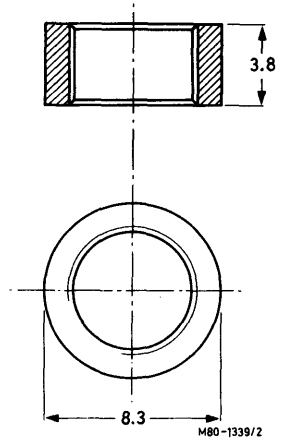
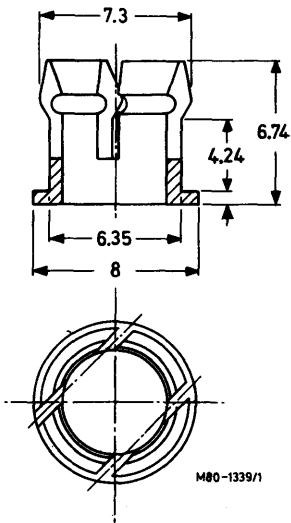

**RATINGS**

Limiting values in accordance with the Absolute Maximum System (IEC 134)

Continuous reverse voltage	$V_R$	max.	3 V
Forward current (d.c.)	$I_F$	max.	20 mA
Forward current (peak value)			
$t_p = 1 \text{ ms}; \delta = 0,33$	$I_{FM}$	max.	60 mA
$t_p = 1 \mu\text{s}; f = 300 \text{ Hz}$	$I_{FM}$	max.	1000 mA
Total power dissipation up to $T_{amb} = 55 \text{ }^\circ\text{C}$	$P_{tot}$	max.	60 mW
Storage temperature	$T_{stg}$		$-55 \text{ to } +100 \text{ }^\circ\text{C}$
Junction temperature	$T_j$	max.	100 $^\circ\text{C}$
Lead soldering temperature			
$> 1,5 \text{ mm}$ from the seating plane; $t_{sld} < 7 \text{ s}$	$T_{sld}$	max.	230 $^\circ\text{C}$

**THERMAL RESISTANCE**

From junction to ambient			
in free air	$R_{th \text{ j-a}}$	=	750 $^\circ\text{C/W}$
mounted on a printed-circuit board	$R_{th \text{ j-a}}$	=	500 $^\circ\text{C/W}$

**CHARACTERISTICS**

$T_j = 25 \text{ }^\circ\text{C}$  unless otherwise specified

Forward voltage			
$I_F = 10 \text{ mA}$	$V_F$	typ.	2,1 V
		<	3 V
Reverse current			
$V_R = 3 \text{ V}$	$I_R$	<	100 $\mu\text{A}$
Diode capacitance			
$V_R = 0; f = 1 \text{ MHz}$	$C_d$	typ.	35 pF
Luminous intensity (on-axis)*			
$I_F = 10 \text{ mA}$	CQX51-I	$I_v$	1,6 to 4,2 mcd
	CQX51-II	$I_v$	3 to 7 mcd
	CQX51-III	$I_v$	5 to 11 mcd
Wavelength at peak emission	$\lambda_{pk}$	typ.	630 nm
Beamwidth between half-intensity directions	$\alpha_{50\%}$	typ.	55 $^\circ$

For applications using a number of devices in close proximity, thus requiring spreads of luminous intensity of less than 2.5 times, production is graded into groups indicated by suffixes. Specific groupings, subject to availability may be obtained only by negotiation with the supplier.



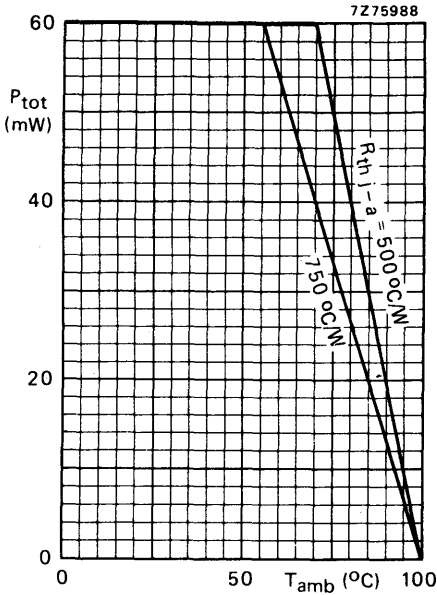

Fig. 5 Maximum permissible power dissipation as a function of ambient temperature.

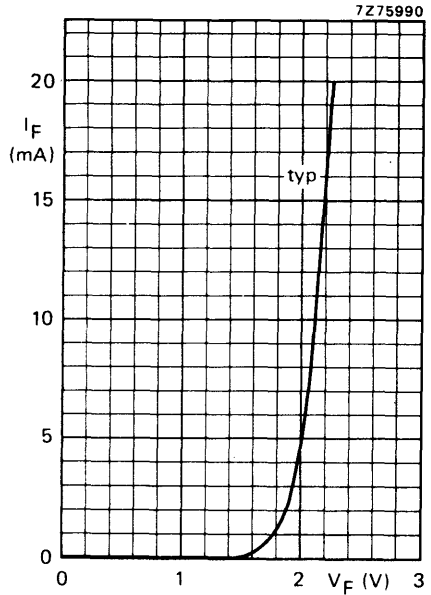

Fig. 6  $T_j = 25\text{ }^\circ\text{C}$ .

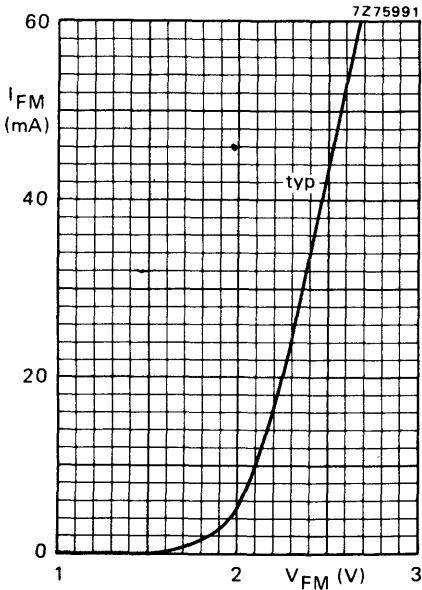

Fig. 7  $t_p = 50\text{ }\mu\text{s}$ ;  $T = 5\text{ ms}$ ;  $T_j = 25\text{ }^\circ\text{C}$ .

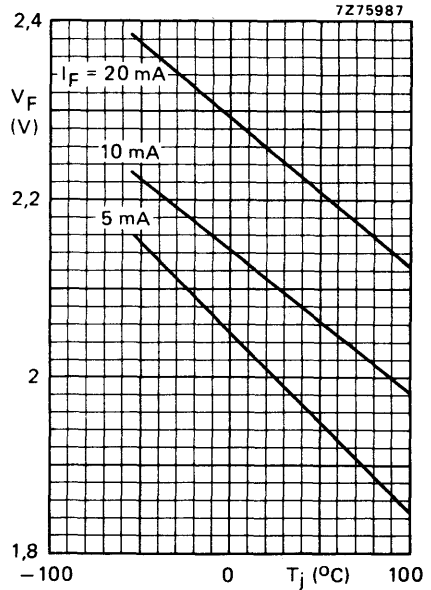

Fig. 8 Typical values.





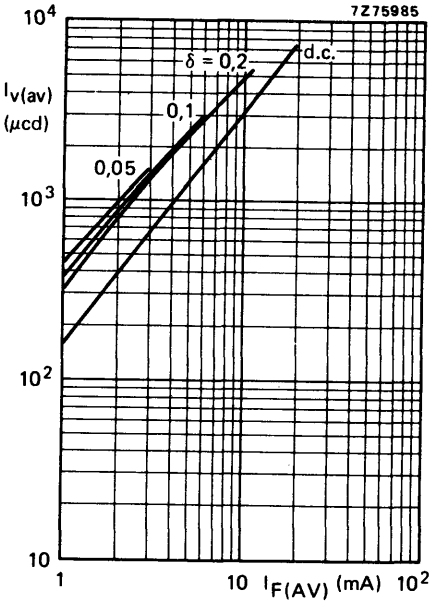

Fig. 9 Typical values;  $T_j = 25^\circ\text{C}$ .

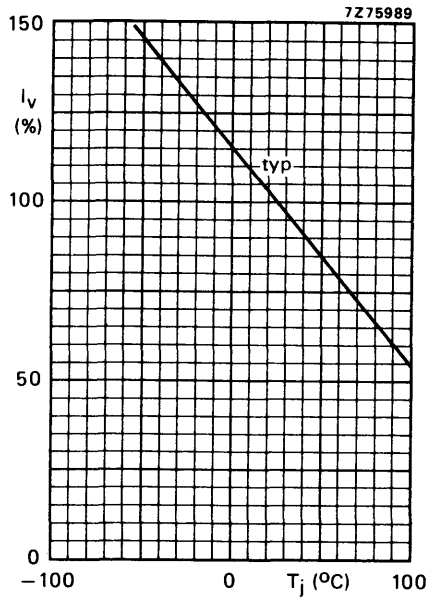

Fig. 10  $I_F = 10$  mA.



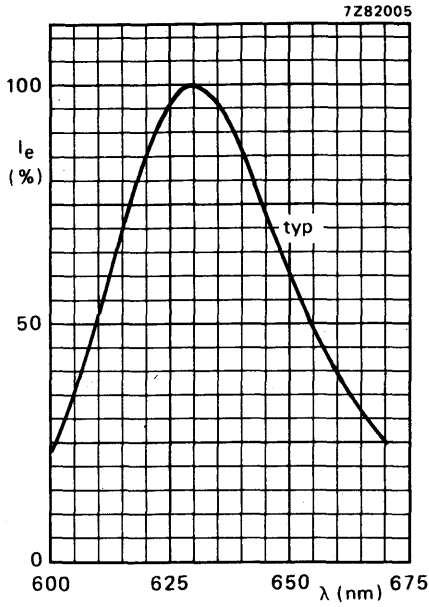

Fig. 11.

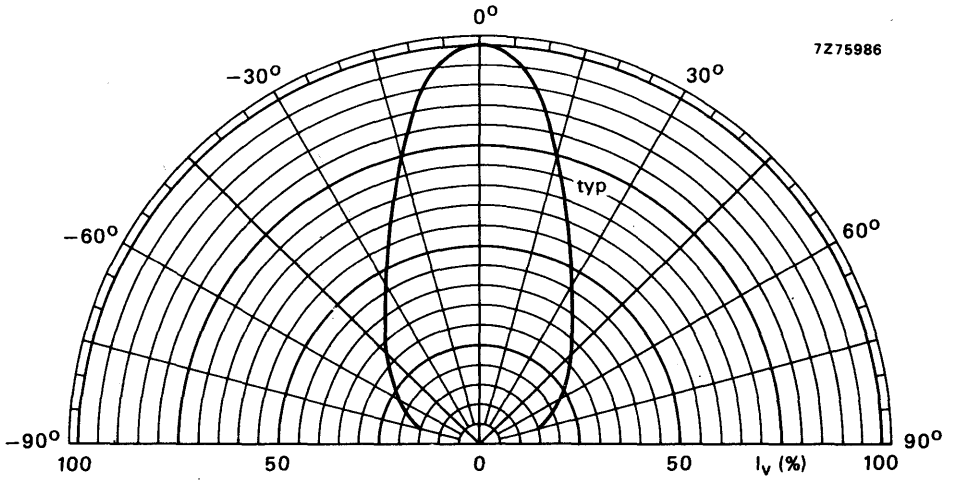

Fig. 12.



## DEVELOPMENT SAMPLE DATA

This information is derived from development samples made available for evaluation. It does not necessarily imply that the device will go into regular production.

CQX54

# HIGH-EFFICIENCY GaAsP RED LIGHT EMITTING DIODE

Gallium arsenide phosphide light emitting diode which emits visible super-red light when forward biased. Plastic envelope with colourless epoxy lens.

## QUICK REFERENCE DATA

Continuous reverse voltage	$V_R$	max.	5 V
Forward current (d.c.)	$I_F$	max.	20 mA
Total power dissipation up to $T_{amb} = 55^\circ\text{C}$	$P_{tot}$	max.	60 mW
Luminous intensity (on-axis) at $I_F = 10\text{ mA}$	$I_v$	>	15 mcd
Wavelength at peak emission	$\lambda_{pk}$	typ.	630 nm
Beamwidth between half-intensity directions	$\alpha_{50\%}$	typ.	$20^\circ$

This data must be read in conjunction with GENERAL SAFETY RECOMMENDATIONS – OPTOELECTRONIC DEVICES

## PRODUCT SAFETY

Modern high technology materials have been used in the manufacture of this device to ensure high performance. Some of these materials are toxic in certain circumstances. Mechanical or electrical damage is unlikely to give rise to any hazard, but toxic vapours may be generated if the device is heated to destruction. Disposal of large quantities should therefore be carried out in accordance with the Deposit of Poisonous Waste Act 1972 and the Control of Pollution Act 1974, or with the latest legislation.

## MECHANICAL DATA

Dimensions in mm

Fig.1 SOD-63 (except distance between base and seating plane), (T-1¼)

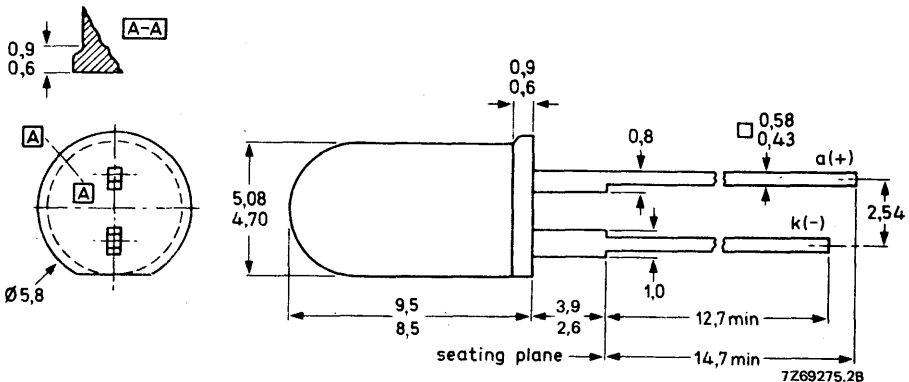

Mullard

December 1980

1

Accessories for panel mounting (panel thickness < 4 mm)

Plastic clip and ring

black type RTC757A

Hole diameter

6,4 mm for panel thickness < 3 mm

6,5 mm for panel thickness > 3 mm

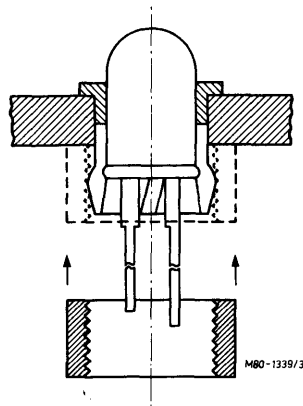
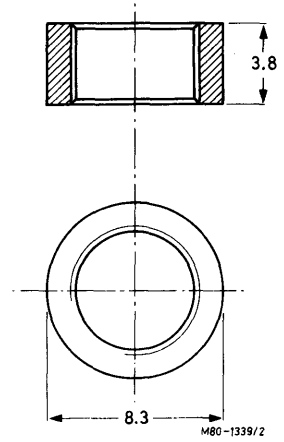
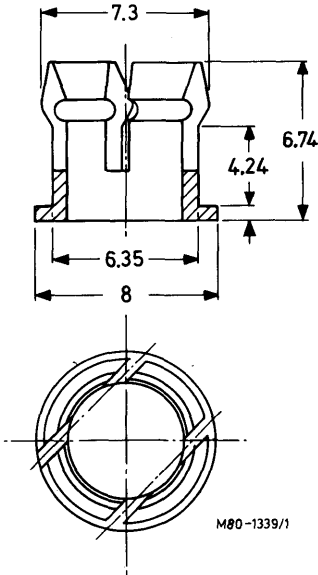

**RATINGS**

Limiting values in accordance with the Absolute Maximum System (IEC 134)

Continuous reverse voltage	$V_R$	max.	5 V
Forward current (d.c.)	$I_F$	max.	20 mA
Forward current (peak value)			
$t_p = 1 \text{ ms}; \delta = 0,33$	$I_{FM}$	max.	60 mA
$t_p = 1 \mu\text{s}; f = 300 \text{ Hz}$	$I_{FM}$	max.	1000 mA
Total power dissipation up to $T_{amb} = 55 \text{ }^\circ\text{C}$	$P_{tot}$	max.	60 mW
Storage temperature	$T_{stg}$		-55 to +100 $^\circ\text{C}$
Junction temperature	$T_j$	max.	100 $^\circ\text{C}$
Lead soldering temperature			
> 1,5 mm from the seating plane; $t_{sld} < 7 \text{ s}$	$T_{sld}$	max.	230 $^\circ\text{C}$

**THERMAL RESISTANCE**

From junction to ambient			
in free air	$R_{th j-a}$	=	750 $^\circ\text{C/W}$
mounted on a printed-circuit board	$R_{th j-a}$	=	500 $^\circ\text{C/W}$

**CHARACTERISTICS**

$T_j = 25 \text{ }^\circ\text{C}$  unless otherwise specified

Forward voltage			
$I_F = 10 \text{ mA}$	$V_F$	typ.	2,1 V
		<	3 V
Reverse current			
$V_R = 5 \text{ V}$	$I_R$	<	100 $\mu\text{A}$
Diode capacitance			
$V_R = 0; f = 1 \text{ MHz}$	$C_d$	typ.	35 pF
Luminous intensity (on-axis)			
$I_F = 10 \text{ mA}$	$I_v$	>	15 mcd
		typ.	20 mcd
Wavelength at peak emission	$\lambda_{pk}$	typ.	630 nm
Beamwidth between half-intensity directions	$\alpha_{50\%}$	typ.	20 $^\circ$



DEVELOPMENT SAMPLE DATA



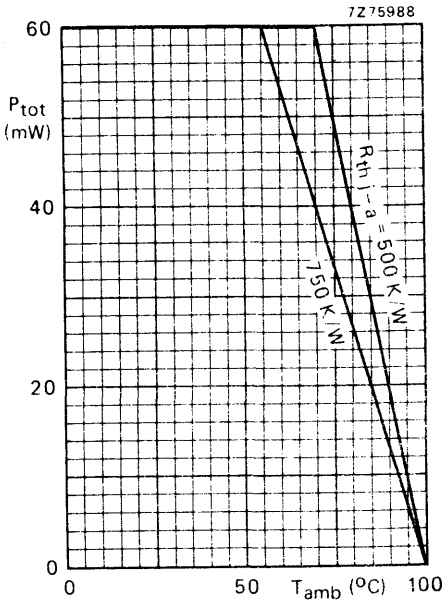

Fig. 5 Maximum permissible power dissipation as a function of ambient temperature.

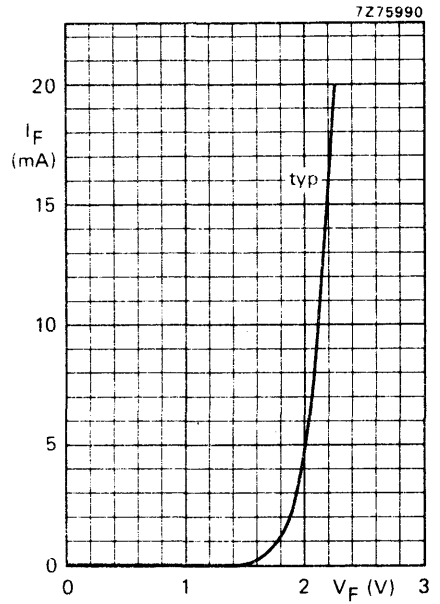

Fig. 6  $T_j = 25 \text{ °C}$ .

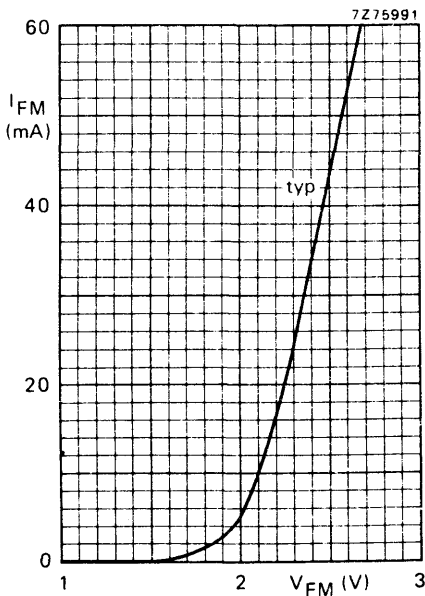

Fig. 7  $t_p = 50 \mu\text{s}$ ;  $T = 5 \text{ ms}$ ;  $T_j = 25 \text{ °C}$ .

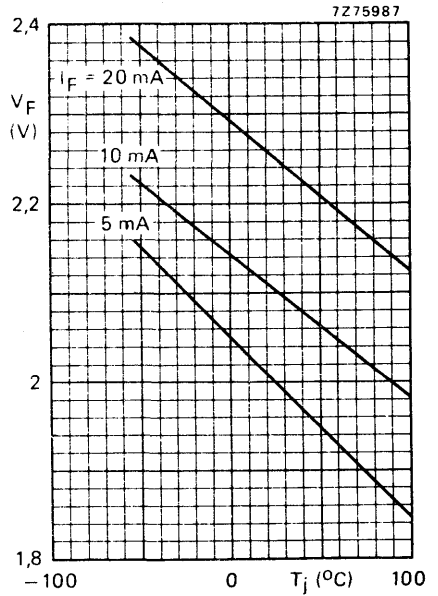

Fig. 8 Typical values.



DEVELOPMENT SAMPLE DATA

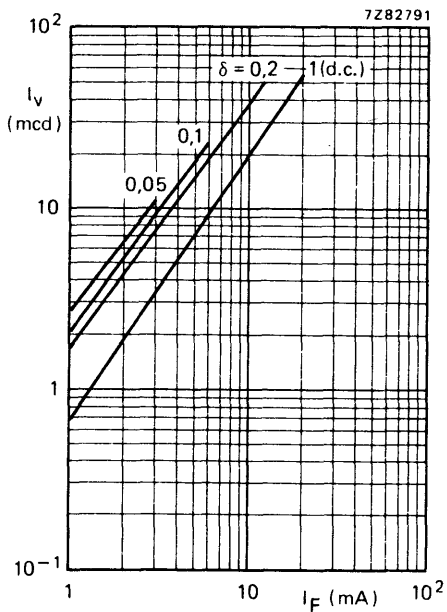

Fig. 9 Typical values;  $T_j = 25^\circ\text{C}$ .

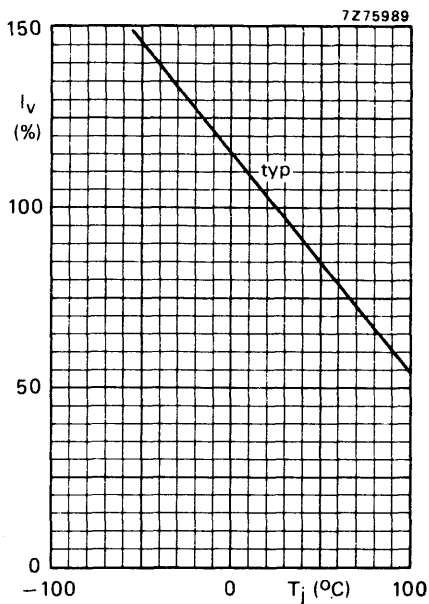

Fig. 10  $I_F = 10\text{ mA}$ .



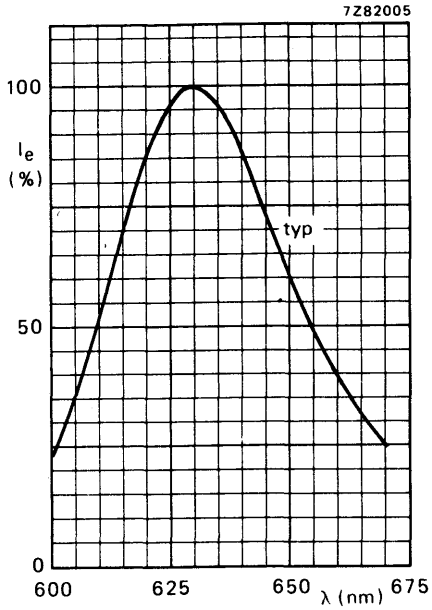

Fig. 11.

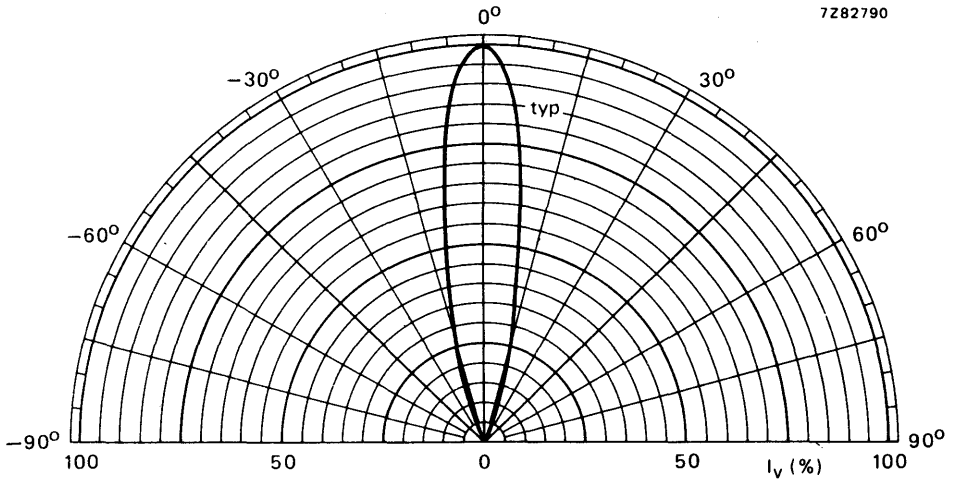

Fig. 12.







CQX55 to 58  
 CQX65 to 68  
 CQX75 to 78

Fig. 1b SOD-63T applicable to CQX56/66/76.

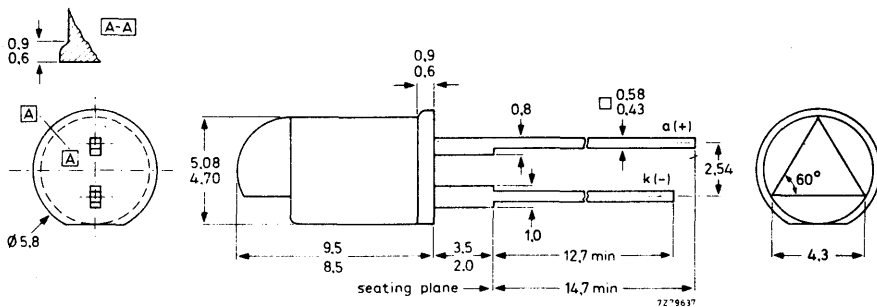

Fig. 1c SOD-63P applicable to CQX57/67/77.

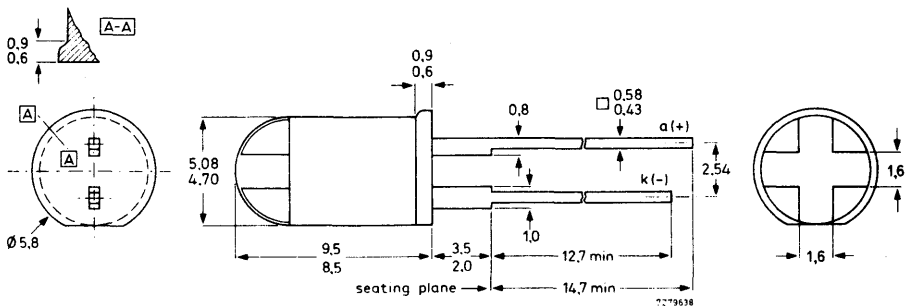
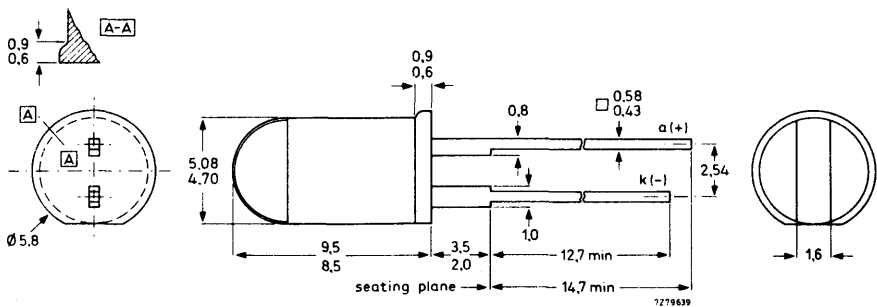

Fig. 1d SOD-63M applicable to CQX58/68/78.



## RATINGS

Limiting values in accordance with the Absolute Maximum System (IEC 134)

Continuous reverse voltage	$V_R$	max.	5 V
Forward current (d.c.)	$I_F$	max.	30 mA
Non-repetitive peak forward current ( $t_p = 10 \mu\text{s}$ )	$I_{FSM}$	max.	1000 mA
Total power dissipation up to $T_{amb} = 25 \text{ }^\circ\text{C}$	$P_{tot}$	max.	120 mW
Storage temperature	$T_{stg}$		-55 to + 100 $^\circ\text{C}$
Junction temperature	$T_j$	max.	100 $^\circ\text{C}$
Lead soldering temperature up to the seating plane; $t_{slid} < 10 \text{ s}$	$T_{slid}$	max.	260 $^\circ\text{C}$

## THERMAL RESISTANCE

From junction to ambient in free air	$R_{th\ j-a}$	=	625 $^\circ\text{C/W}$
--------------------------------------	---------------	---	------------------------

## CHARACTERISTICS

 $T_j = 25 \text{ }^\circ\text{C}$ 

Forward voltage $I_F = 10 \text{ mA}$	$V_F$	typ. <	2,1 V 3,0 V
Reverse current $V_R = 5 \text{ V}$	$I_R$	<	100 $\mu\text{A}$
Diode capacitance $V_R = 0$ ; $f = 1 \text{ MHz}$	$C_d$	typ.	35 pF
Luminous intensity (on-axis) $I_F = 10 \text{ mA}$	$I_v$	> typ.	0,5 mcd 1,0 mcd
Wavelength at peak emission $I_F = 10 \text{ mA}$	$\lambda_{pk}$	typ.	630 nm
	$\lambda_{pk}$	typ.	560 nm
	$\lambda_{pk}$	typ.	590 nm

CQX55 to 58

CQX65 to 68

CQX75 to 78

 $\lambda_{pk}$  $\lambda_{pk}$  $\lambda_{pk}$ 

typ.

typ.

typ.

630 nm

560 nm

590 nm



CQX55 to 58  
 CQX65 to 68  
 CQX75 to 78

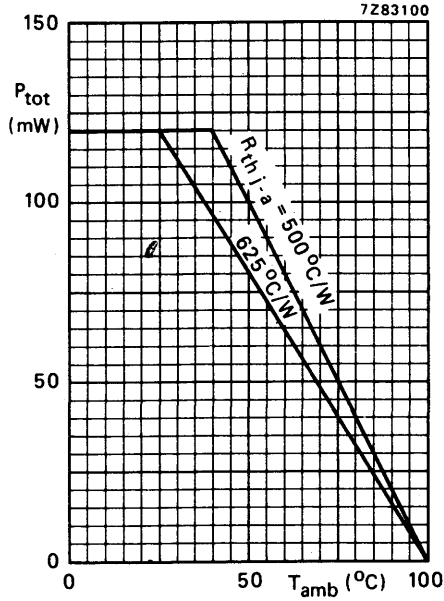

Fig. 2 Power/temperature derating curves.

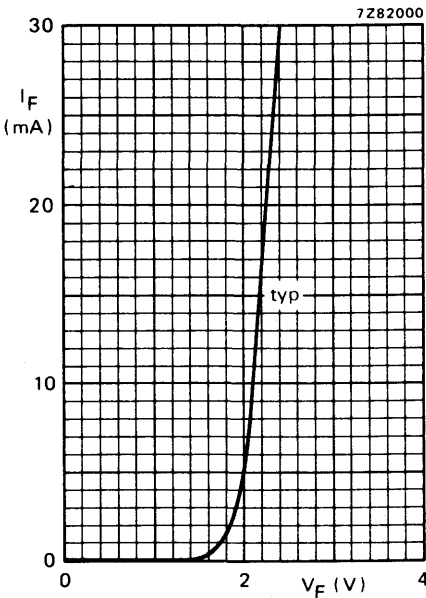

Fig. 3  $T_j = 25\text{ }^{\circ}\text{C}$ .

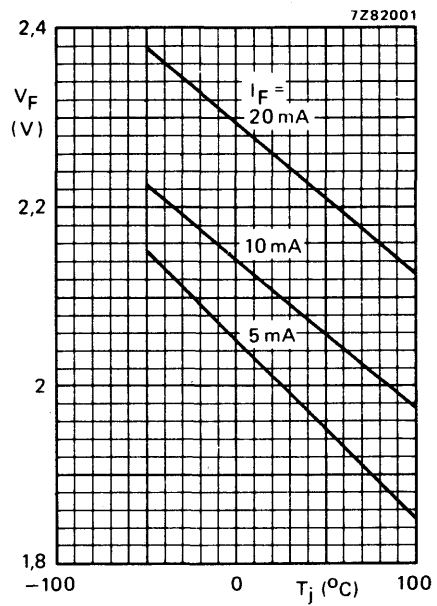

Fig. 4 Typical values.



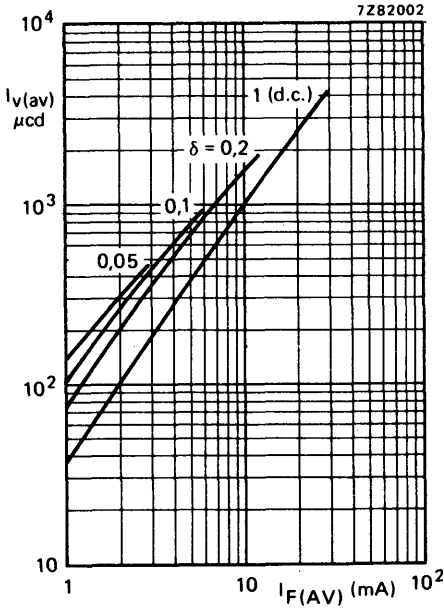

Fig. 5 CQX55 to 58; typ. values;  $T_j = 25^\circ\text{C}$ .

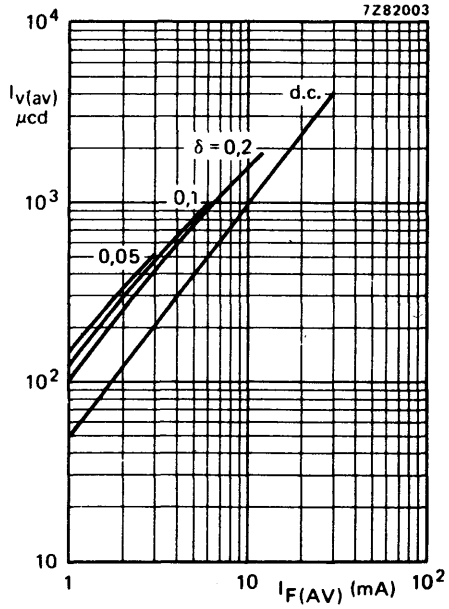

Fig. 6 CQX65 to 68; CQX75 to 78; typical values;  $T_j = 25^\circ\text{C}$ .

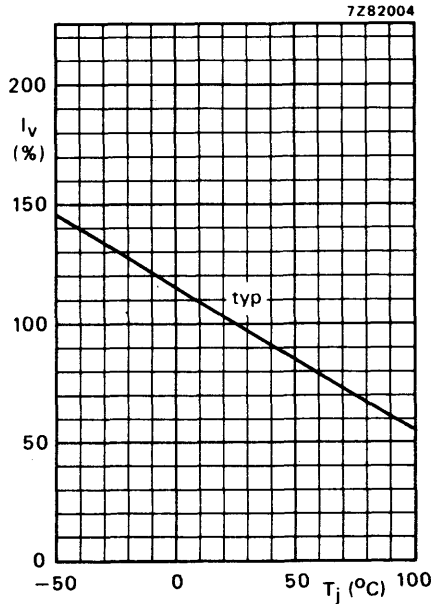

Fig. 7  $I_F = 10\text{ mA}$ .



CQX55 to 58  
 CQX65 to 68  
 CQX75 to 78

7Z82005

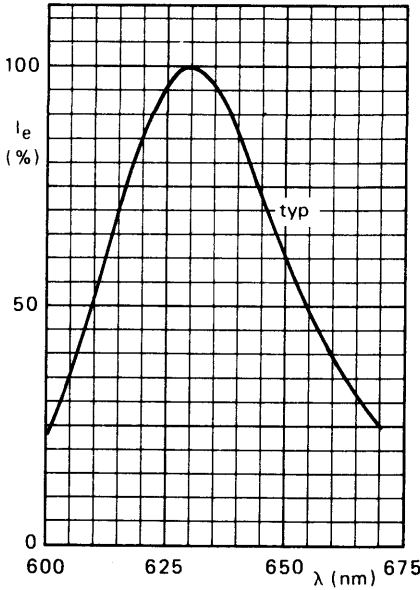

Fig. 8 CQX55 to 58.

7Z82006

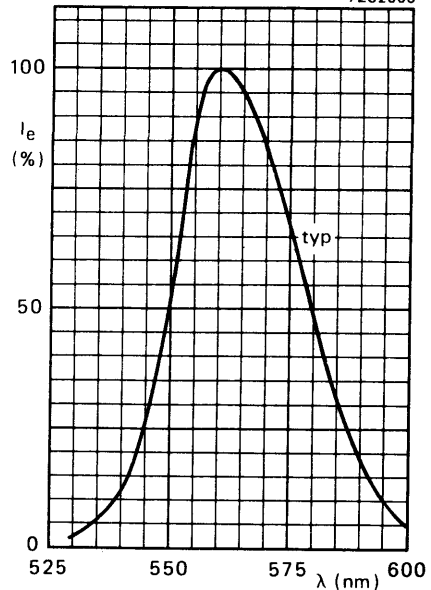

Fig. 9 CQX65 to 68.

7Z82007

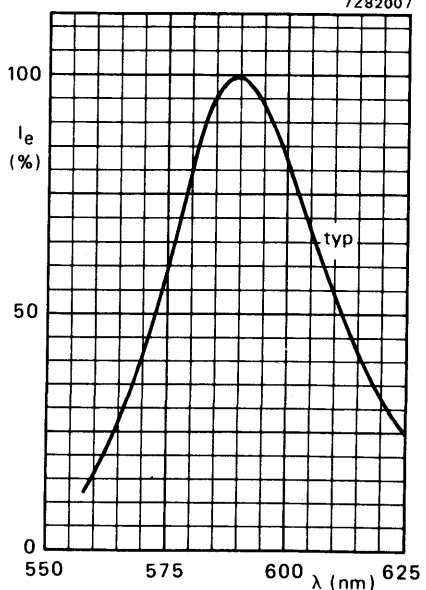

Fig. 10 CQX75 to 78.



## DEVELOPMENT SAMPLE DATA

This information is derived from development samples made available for evaluation. It does not necessarily imply that the device will go into regular production.

CQX64

## HIGH-EFFICIENCY GaP GREEN LIGHT EMITTING DIODE

Gallium phosphide light emitting diode which emits green light when forward biased. Plastic envelope with colourless epoxy lens.

### QUICK REFERENCE DATA

Continuous reverse voltage	$V_R$	max.	5 V
Forward current (d.c.)	$I_F$	max.	20 mA
Total power dissipation up to $T_{amb} = 55^\circ\text{C}$	$P_{tot}$	max.	60 mW
Luminous intensity (on-axis) at $I_F = 10\text{ mA}$	$I_v$	>	15 mcd
Wavelength at peak emission	$\lambda_{pk}$	typ.	560 nm
Beamwidth between half-intensity directions	$\alpha_{50\%}$	typ.	$20^\circ$

This data must be read in conjunction with GENERAL SAFETY RECOMMENDATIONS – OPTOELECTRONIC DEVICES

### PRODUCT SAFETY

Modern high technology materials have been used in the manufacture of this device to ensure high performance. Some of these materials are toxic in certain circumstances. Mechanical or electrical damage is unlikely to give rise to any hazard, but toxic vapours may be generated if the device is heated to destruction. Disposal of large quantities should therefore be carried out in accordance with the Deposit of Poisonous Waste Act 1972 and the Control of Pollution Act 1974, or with the latest legislation.

### MECHANICAL DATA

Dimensions in mm

Fig. 1 SOD-63 (except distance between base and seating plane), (T-1¼)

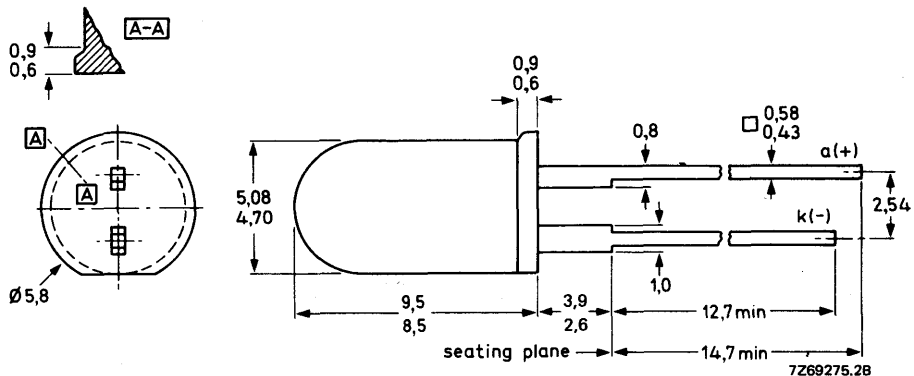

Mullard

November 1980

1

Accessories for panel mounting (panel thickness < 4 mm)

Plastic clip and ring

black type RTC757A

Hole diameter

6,4 mm for panel thickness < 3 mm

6,5 mm for panel thickness > 3 mm

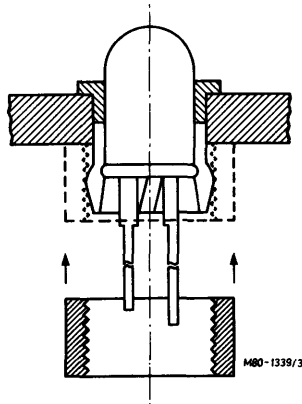
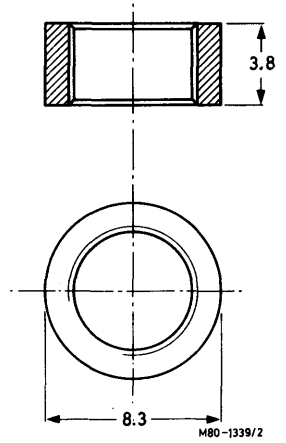
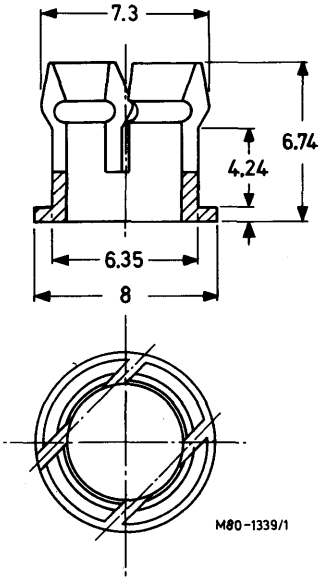



**RATINGS**

Limiting values in accordance with the Absolute Maximum System (IEC 134)

Continuous reverse voltage	$V_R$	max.	5 V
Forward current (d.c.)	$I_F$	max.	20 mA
Forward current (peak value)			
$t_p = 1 \text{ ms}; \delta = 0,33$	$I_{FM}$	max.	60 mA
$t_p = 1 \mu\text{s}; f = 300 \text{ Hz}$	$I_{FM}$	max.	1000 mA
Total power dissipation up to $T_{amb} = 55 \text{ }^\circ\text{C}$	$P_{tot}$	max.	60 mW
Storage temperature	$T_{stg}$		-55 to +100 $^\circ\text{C}$
Junction temperature	$T_j$	max.	100 $^\circ\text{C}$
Lead soldering temperature			
> 1,5 mm from the seating plane; $t_{sld} < 7 \text{ s}$	$T_{sld}$	max.	230 $^\circ\text{C}$

**THERMAL RESISTANCE**

From junction to ambient in free air	$R_{th j-a}$	=	750 $^\circ\text{C/W}$
mounted on a printed-circuit board	$R_{th j-a}$	=	500 $^\circ\text{C/W}$

**CHARACTERISTICS**

$T_j = 25 \text{ }^\circ\text{C}$  unless otherwise specified

Forward voltage			
$I_F = 10 \text{ mA}$	$V_F$	typ. <	2,1 V 3 V
Reverse current			
$V_R = 5 \text{ V}$	$I_R$	<	100 $\mu\text{A}$
Diode capacitance			
$V_R = 0; f = 1 \text{ MHz}$	$C_d$	typ.	35 pF
Luminous intensity (on-axis)			
$I_F = 10 \text{ mA}$	$I_v$	> typ.	15 mcd 20 mcd
Wavelength at peak emission	$\lambda_{pk}$	typ.	560 nm
Beamwidth between half-intensity directions	$\alpha_{50\%}$	typ.	20 $^\circ$

DEVELOPMENT SAMPLE DATA



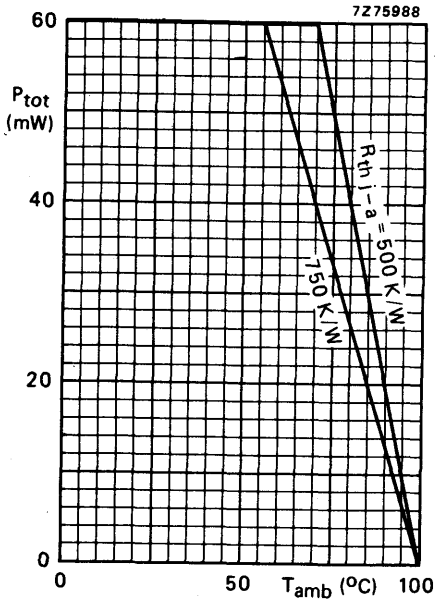

Fig. 5 Maximum permissible power dissipation as a function of ambient temperature.

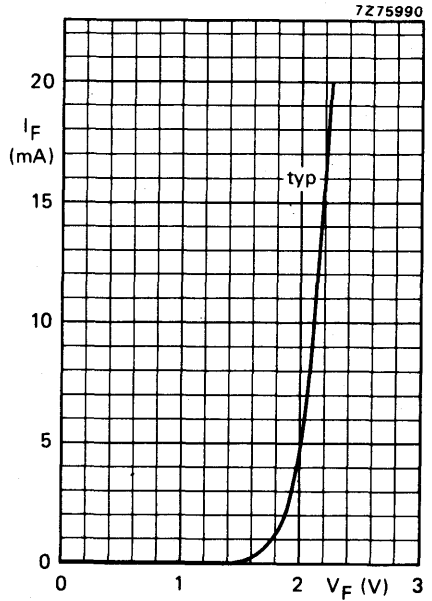

Fig. 6  $T_j = 25\text{ }^\circ\text{C}$ .

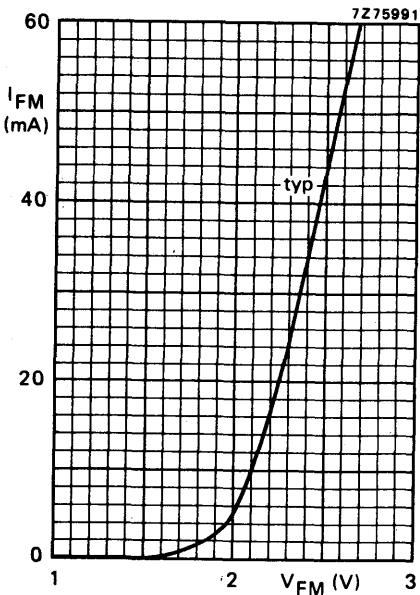

Fig. 7  $t_p = 50\text{ }\mu\text{s}$ ;  $T = 5\text{ ms}$ ;  $T_j = 25\text{ }^\circ\text{C}$ .

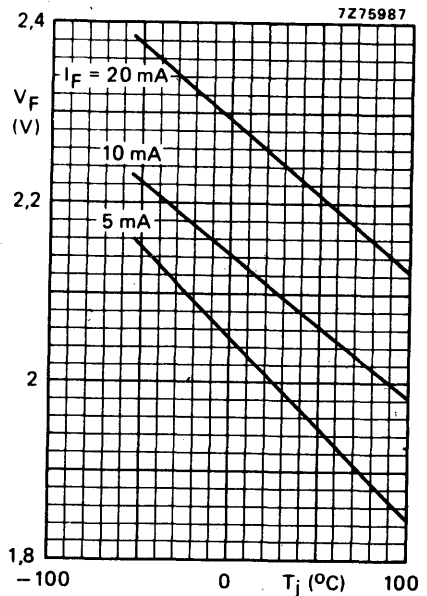

Fig. 8 Typical values.



DEVELOPMENT SAMPLE DATA

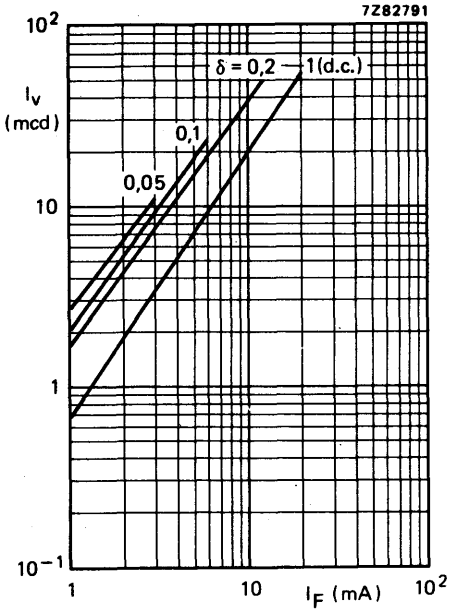

Fig. 9 Typical values;  $T_j = 25^\circ C.$

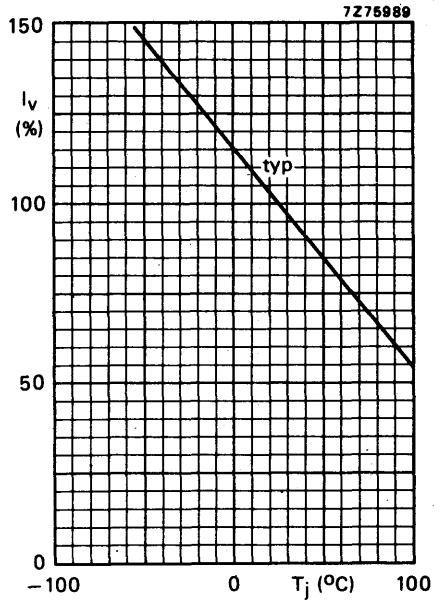

Fig. 10  $I_F = 10$  mA.



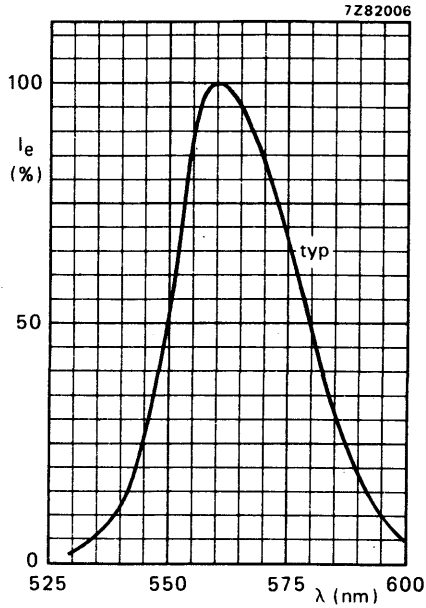

Fig. 11.

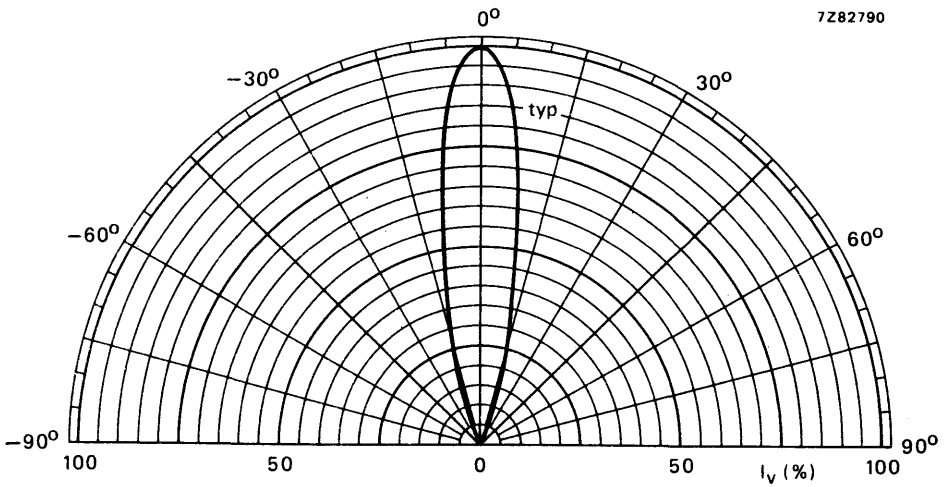

Fig. 12.



## DEVELOPMENT SAMPLE DATA

This information is derived from development samples made available for evaluation. It does not necessarily imply that the device will go into regular production.

CQX74

## HIGH-EFFICIENCY GaAsP YELLOW LIGHT EMITTING DIODE

Gallium arsenide phosphide light emitting diode which emits yellow light when forward biased. Plastic envelope with colourless epoxy lens.

### QUICK REFERENCE DATA

Continuous reverse voltage	$V_R$	max.	5 V
Forward current (d.c.)	$I_F$	max.	20 mA
Total power dissipation up to $T_{amb} = 55\text{ }^\circ\text{C}$	$P_{tot}$	max.	60 mW
Luminous intensity (on-axis) at $I_F = 10\text{ mA}$	$I_v$	>	15 mcd
Wavelength at peak emission	$\lambda_{pk}$	typ.	590 nm
Beamwidth between half-intensity directions	$\alpha_{50\%}$	typ.	$20^\circ$

This data must be read in conjunction with GENERAL SAFETY RECOMMENDATIONS – OPTOELECTRONIC DEVICES

### PRODUCT SAFETY

Modern high technology materials have been used in the manufacture of this device to ensure high performance. Some of these materials are toxic in certain circumstances. Mechanical or electrical damage is unlikely to give rise to any hazard, but toxic vapours may be generated if the device is heated to destruction. Disposal of large quantities should therefore be carried out in accordance with the Deposit of Poisonous Waste Act 1972 and the Control of Pollution Act 1974, or with the latest legislation.

### MECHANICAL DATA

Dimensions in mm

Fig. 1 SOD-63 (except distance between base and seating plane). (T-1%)

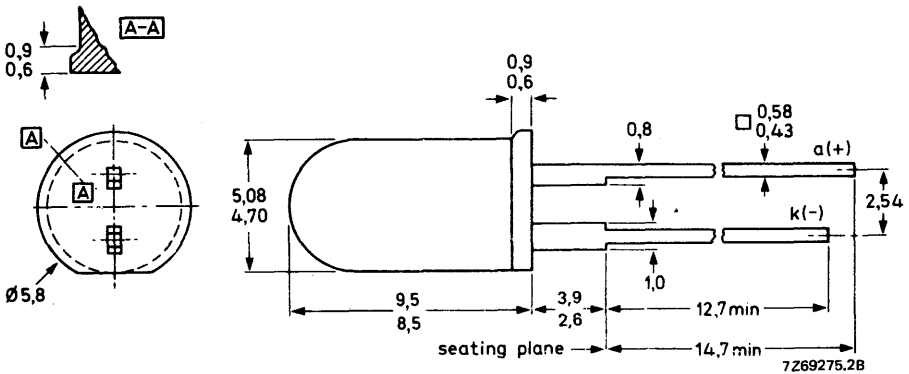

Mullard

November 1980

1

CQX74

**Accessories for panel mounting** (panel thickness < 4 mm)

Plastic clip and ring

black type RTC757A

Hole diameter

6,4 mm for panel thickness < 3 mm

6,5 mm for panel thickness > 3 mm

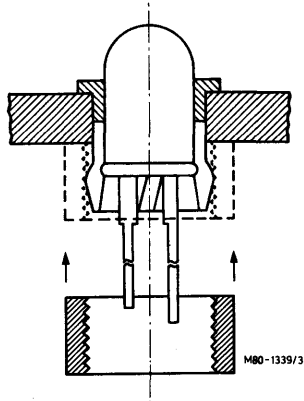
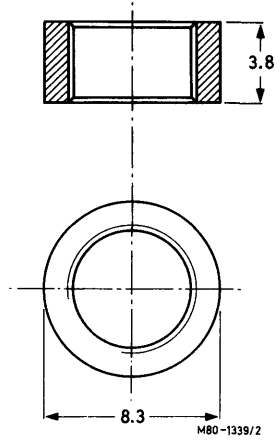
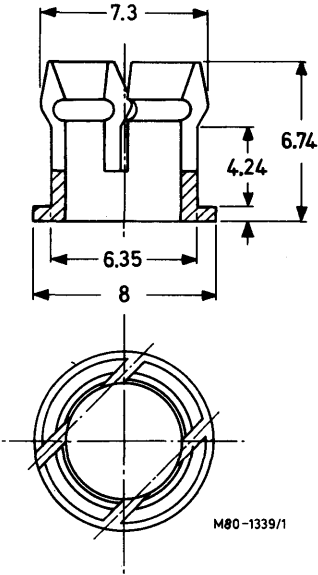

**RATINGS**

Limiting values in accordance with the Absolute Maximum System (IEC 134)

Continuous reverse voltage	$V_R$	max.	5 V
Forward current (d.c.)	$I_F$	max.	20 mA
Forward current (peak value)			
$t_p = 1 \text{ ms}; \delta = 0,33$	$I_{FM}$	max.	60 mA
$t_p = 1 \mu\text{s}; f = 300 \text{ Hz}$	$I_{FM}$	max.	1000 mA
Total power dissipation up to $T_{amb} = 55 \text{ }^\circ\text{C}$	$P_{tot}$	max.	60 mW
Storage temperature	$T_{stg}$		-55 to +100 $^\circ\text{C}$
Junction temperature	$T_j$	max.	100 $^\circ\text{C}$
Lead soldering temperature			
>1,5 mm from the seating plane; $t_{sld} < 7 \text{ s}$	$T_{sld}$	max.	230 $^\circ\text{C}$

**THERMAL RESISTANCE**

From junction to ambient			
in free air	$R_{th\ j-a}$	=	750 $^\circ\text{C/W}$
mounted on a printed-circuit board	$R_{th\ j-a}$	=	500 $^\circ\text{C/W}$

**CHARACTERISTICS**

$T_j = 25 \text{ }^\circ\text{C}$  unless otherwise specified

Forward voltage			
$I_F = 10 \text{ mA}$	$V_F$	typ.	2,1 V
		<	3 V
Reverse current			
$V_R = 5 \text{ V}$	$I_R$	<	100 $\mu\text{A}$
Diode capacitance			
$V_R = 0; f = 1 \text{ MHz}$	$C_d$	typ.	35 pF
Luminous intensity (on-axis)			
$I_F = 10 \text{ mA}$	$I_v$	>	15 mcd
		typ.	20 mcd
Wavelength at peak emission	$\lambda_{pk}$	typ.	590 nm
Beamwidth between half-intensity directions	$\alpha_{50\%}$	typ.	20 $^\circ$

DEVELOPMENT SAMPLE DATA



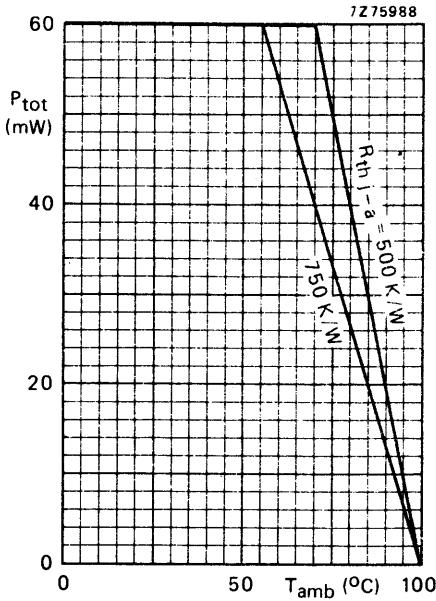

Fig. 5 Maximum permissible power dissipation as a function of ambient temperature.

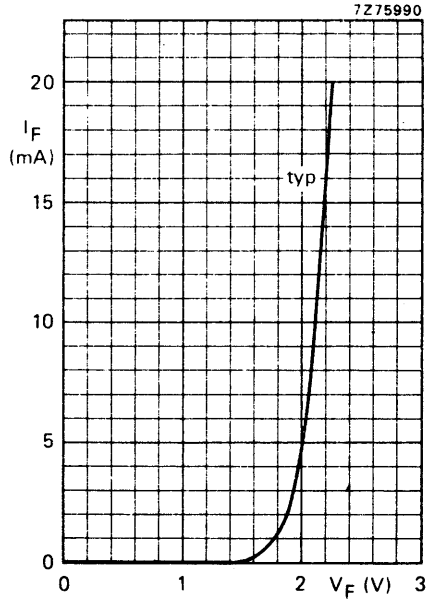

Fig. 6  $T_j = 25\text{ }^\circ\text{C}$ .

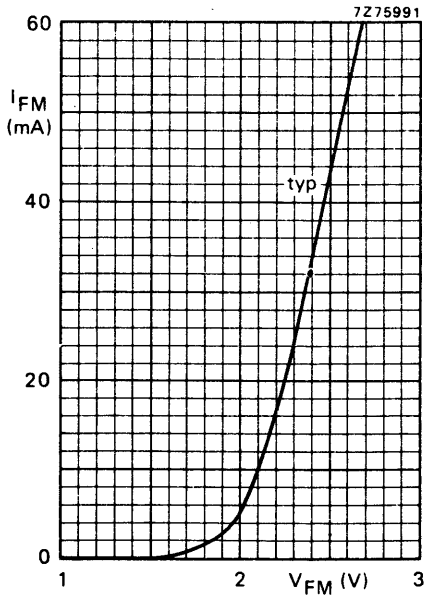

Fig. 7  $t_p = 50\text{ }\mu\text{s}$ ;  $T = 5\text{ ms}$ ;  $T_j = 25\text{ }^\circ\text{C}$ .

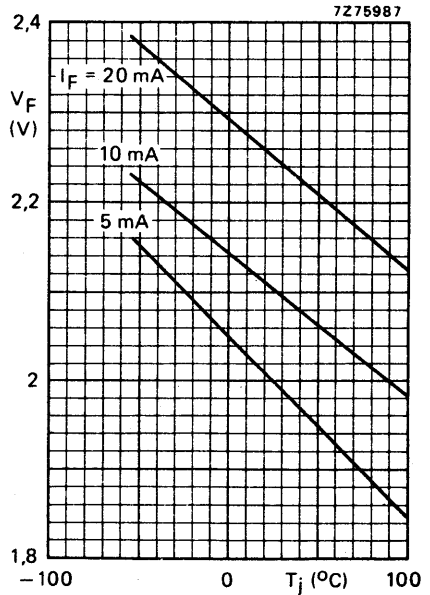

Fig. 8 Typical values.





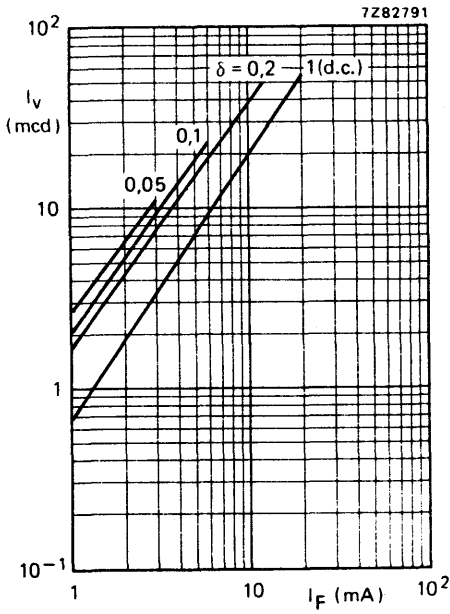

Fig. 9 Typical values;  $T_j = 25^\circ\text{C}$ .

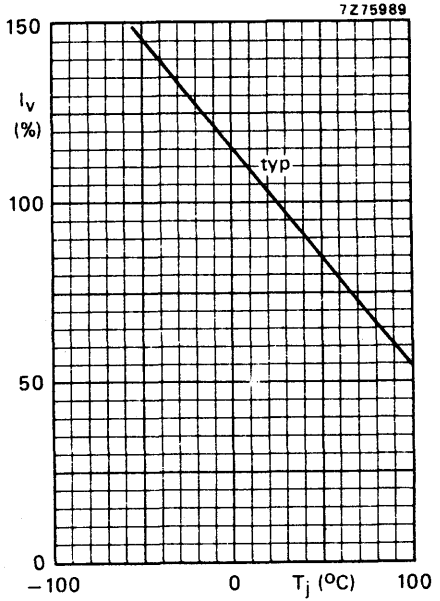
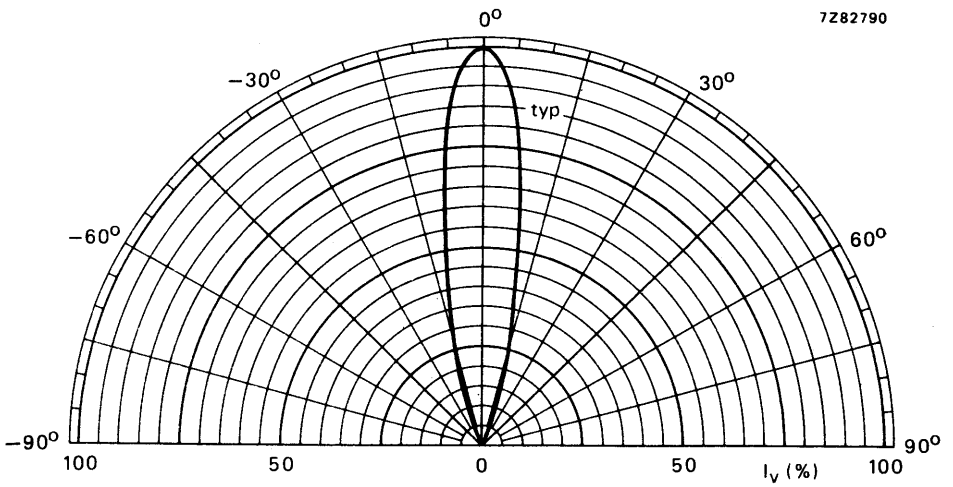
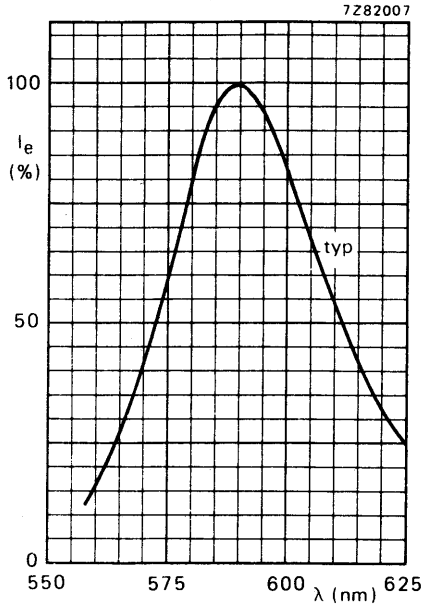

Fig. 10  $I_F = 10\text{ mA}$ .

DEVELOPMENT SAMPLE DATA





## GaAs LIGHT EMITTING DIODE

Gallium arsenide light emitting diode intended for optical coupling and encoding. It emits radiation in the near infrared when forward biased. The diode is provided with a flat glass window.

### QUICK REFERENCE DATA

Continuous reverse voltage	$V_R$	max.	2 V
Forward current (d. c.)	$I_F$	max.	30 mA
Forward current (peak value) $t_p = 100 \mu\text{s}; \delta = 0, 1$	$I_{FM}$	max.	200 mA
Total power dissipation up to $T_{amb} = 95 \text{ }^\circ\text{C}$	$P_{tot}$	max.	50 mW
Total radiant power at $I_F = 20 \text{ mA}$	$\phi_e$	> typ.	60 $\mu\text{W}$ 100 $\mu\text{W}$
Radiant intensity (on-axis) at $I_F = 20 \text{ mA}$	$I_e$	typ.	64 $\mu\text{W/sr}$
Light rise time at $I_{F on} = 20 \text{ mA}$	$t_r$	<	100 ns
Light fall time at $I_{F on} = 20 \text{ mA}$	$t_f$	<	100 ns
Wavelength at peak emission	$\lambda_{pk}$	typ.	880 nm
Thermal resistance from junction to ambient	$R_{th j-a}$	=	0,6 $^\circ\text{C/mW}$

This data must be read in conjunction with GENERAL SAFETY RECOMMENDATIONS – OPTOELECTRONIC DEVICES

### PRODUCT SAFETY

Modern high technology materials have been used in the manufacture of this device to ensure high performance. Some of these materials are toxic in certain circumstances. Mechanical or electrical damage is unlikely to give rise to any hazard, but toxic vapours may be generated if the device is heated to destruction. Disposal of large quantities should therefore be carried out in accordance with the Deposit of Poisonous Waste Act 1972 and the Control of Pollution Act 1974, or with the latest legislation.

### MECHANICAL DATA

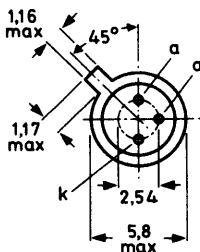

TO-18, except for window

Dimensions in mm

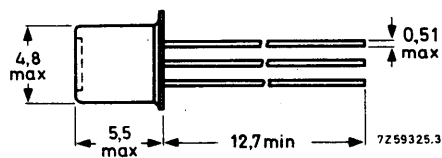

Max. lead diameter is guaranteed only for 12,7 mm



**RATINGS** Limiting values in accordance with the Absolute Maximum System (IEC 134)

Voltage

Continuous reverse voltage  $V_R$  max. 2 V

Current

Forward current (d. c.)  $I_F$  max. 30 mA

Forward current (peak value)  
 $t_p = 100 \mu s; \delta = 0, 1$   $I_{FM}$  max. 200 mA

Power dissipation

Total power dissipation up to  $T_{amb} = 95 \text{ }^\circ\text{C}$   $P_{tot}$  max. 50 mW

Temperature

Storage temperature  $T_{stg}$  -55 to +150  $^\circ\text{C}$

Operating junction temperature  $T_j$  max. 125  $^\circ\text{C}$

**THERMAL RESISTANCE**

From junction to ambient in free air  $R_{th j-a} = 0, 6 \text{ }^\circ\text{C/mW}$

From junction to case  $R_{th j-c} = 0, 22 \text{ }^\circ\text{C/mW}$

**CHARACTERISTICS**

$T_{amb} = 25 \text{ }^\circ\text{C}$  unless otherwise specified

Forward voltage at  $I_F = 30 \text{ mA}$   $V_F$  typ. 1, 3 V  
 < 1, 6 V

$I_{FM} = 0, 2 \text{ A}$   $V_F$  typ. 1, 5 V

Reverse current at  $V_R = 2 \text{ V}$   $I_R$  < 0, 5 mA

Diode capacitance at  $f = 1 \text{ MHz}; V_R = 0$   $C_d$  typ. 65 pF



## CHARACTERISTICS (continued)

 $T_{amb} = 25\text{ }^{\circ}\text{C}$  unless otherwise specified

Radiant output power at $I_F = 20\text{ mA}$	$\phi_e$	>	60	$\mu\text{W}$
		typ.	100	$\mu\text{W}$
$I_F = 20\text{ mA}; T_j = 100\text{ }^{\circ}\text{C}$	$\phi_e$	typ.	50	$\mu\text{W}$
	$I_F = 200\text{ mA}$ <sup>1)</sup>	$\phi_e$	typ.	1, 16
Radiant intensity (on-axis) at $I_F = 20\text{ mA}$	$I_e$	typ.	64	$\mu\text{W}/\text{sr}$
	$L_e$	typ.	1, 6	$\text{mW}/\text{mm}^2\text{sr}$
Radiance at $I_F = 20\text{ mA}$ $I_F = 200\text{ mA}$ <sup>1)</sup>	$L_e$	typ.	15	$\text{mW}/\text{mm}^2\text{sr}$
	$A_e$	typ.	0, 04	$\text{mm}^2$
Emissive area	$\lambda_{pk}$	typ.	880	nm
Wavelength at peak emission	$\Delta\lambda$	typ.	40	nm
Bandwidth at half height	$t_r$	typ.	30	ns
		<	100	ns
Light rise time at $I_{Fon} = 20\text{ mA}$	$t_f$	typ.	30	ns
		<	100	ns
Light fall time at $I_{Fon} = 20\text{ mA}$				

<sup>1)</sup>  $t_p = 100\text{ }\mu\text{s}; \delta = 0, 1.$ 

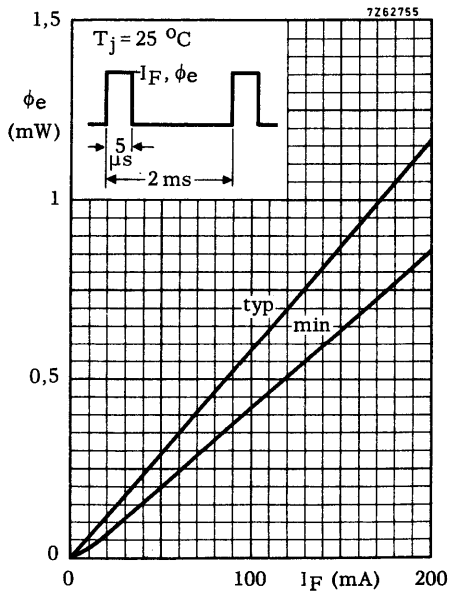
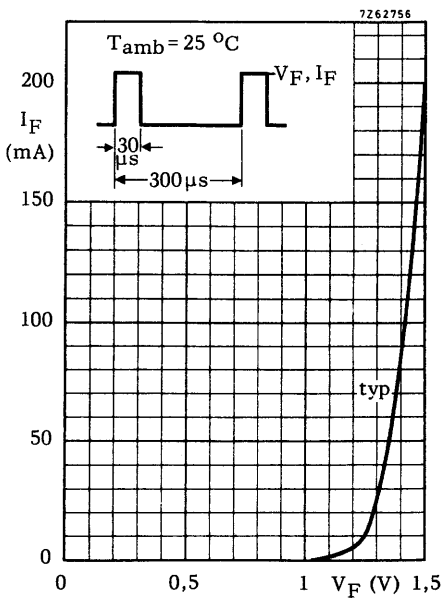
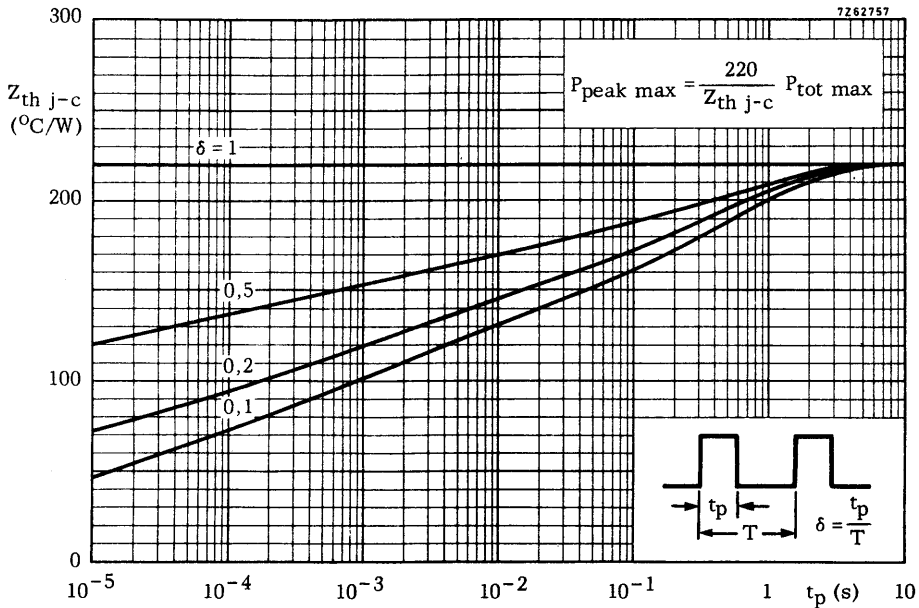

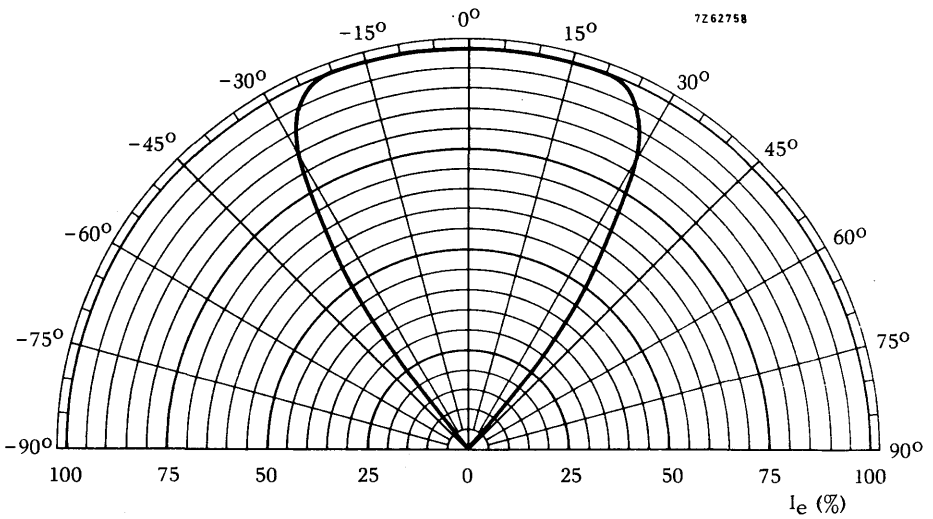
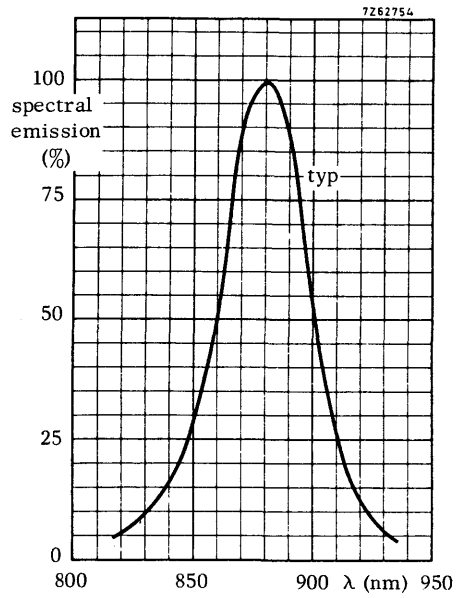
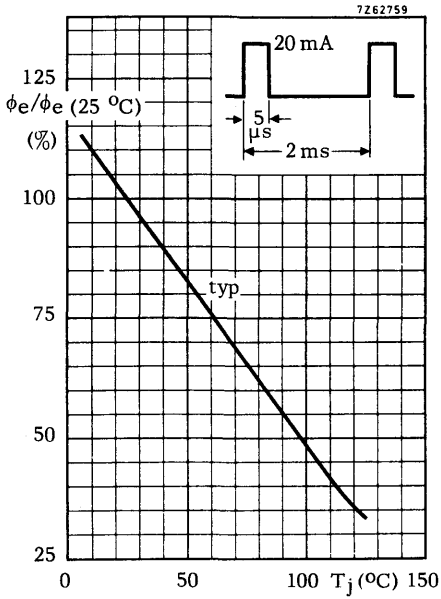





## GALLIUM ARSENIDE LIGHT EMITTING DIODE

Gallium arsenide light emitting diode intended for optical coupling and encoding. It emits radiation in the near infrared when forward biased. Suitable for combination with photo-transistor BPX25 .

QUICK REFERENCE DATA			
Continuous reverse voltage	$V_R$	max.	2 V
Forward current (d. c.)	$I_F$	max.	30 mA
Forward current (peak value)	$I_{FM}$	max.	200 mA
Total power dissipation up to $T_{amb} = 95\text{ }^\circ\text{C}$	$P_{tot}$	max.	50 mW
Total radiant power at $I_F = 20\text{ mA}$	$\phi_e$	typ.	50 $\mu\text{W}$
Radiant intensity (on-axis) at $I_F = 20\text{ mA}$	$I_e$	typ.	1,25 mW/sr
Light rise time at $I_{Fon} = 20\text{ mA}$	$t_r$	<	100 ns
Light fall time at $I_{Fon} = 20\text{ mA}$	$t_f$	<	100 ns
Wavelength at peak emission	$\lambda_{pk}$	typ.	880 nm
Thermal resistance from junction to ambient	$R_{th\ j-a}$	=	0,6 $^\circ\text{C/mW}$

**This data must be read in conjunction with GENERAL SAFETY RECOMMENDATIONS – OPTOELECTRONIC DEVICES**

### PRODUCT SAFETY

Modern high technology materials have been used in the manufacture of this device to ensure high performance. Some of these materials are toxic in certain circumstances. Mechanical or electrical damage is unlikely to give rise to any hazard, but toxic vapours may be generated if the device is heated to destruction. Disposal of large quantities should therefore be carried out in accordance with the Deposit of Poisonous Waste Act 1972 and the Control of Pollution Act 1974, or with the latest legislation.

### MECHANICAL DATA

Dimensions in mm

TO-18, except for lens

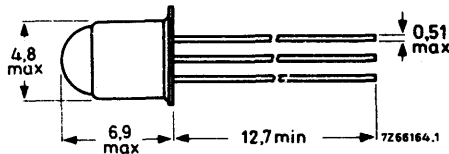
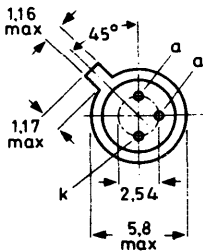

**RATINGS** Limiting values in accordance with the Absolute Maximum System (IEC 134)

Voltage

Continuous reverse voltage  $V_R$  max. 2 V

Current

Forward current (d. c.)  $I_F$  max. 30 mA

Forward current (peak value)  
 $t_p = 100 \mu s; \delta = 0, 1$   $I_{FM}$  max. 200 mA

Power dissipation

Total power dissipation up to  
 $T_{amb} = 95 \text{ }^\circ\text{C}$   $P_{tot}$  max. 50 mW

Temperature

Storage temperature  $T_{stg}$  -55 to +150  $^\circ\text{C}$

Junction temperature  $T_j$  max. 125  $^\circ\text{C}$

**THERMAL RESISTANCE**

From junction to ambient in free air  $R_{th j-a} = 0,6 \text{ }^\circ\text{C/mW}$

From junction to case  $R_{th j-c} = 0,22 \text{ }^\circ\text{C/mW}$

**CHARACTERISTICS**

$T_{amb} = 25 \text{ }^\circ\text{C}$  unless otherwise specified

Forward voltage

$I_F = 30 \text{ mA}$   $V_F$  typ. 1,3 V

< 1,6 V

$I_{FM} = 200 \text{ mA}$   $V_F$  typ. 1,5 V

Reverse current

$V_R = 2 \text{ V}$   $I_R$  < 0,5 mA

Diode capacitance

$V_R = 0; f = 20 \text{ MHz}$   $C_d$  typ. 25 pF

Total radiant power

$I_F = 20 \text{ mA}$   $\phi_e$  typ. 50  $\mu\text{W}$

Radiant intensity (on-axis)

$I_F = 20 \text{ mA}$   $I_e$  typ. 1,25 mW/sr



CHARACTERISTICS (continued)

Mean irradiance

on a receiving area with  $D = 2 \text{ mm}$  at a distance  $a = 10 \text{ mm}$  and at  $I_F = 20 \text{ mA}$ , measured as below

$E_e$	>	0,28	$\text{mW/cm}^2$
	typ.	0,50	$\text{mW/cm}^2$ <sup>1)</sup>

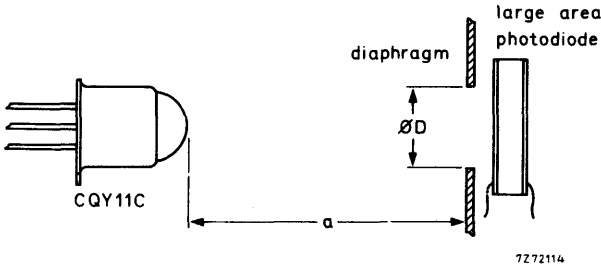

Fig. 1

<u>Decrease of radiant power with temperature</u>	$\frac{\Delta \phi_e}{\Delta T_j}$	typ.	0,7	%/°C
<u>Cross section of the radiant beam</u>				
between 0 to 10 mm from the lens	$A_{\text{beam}}$	typ.	7	$\text{mm}^2$
<u>Angle between optical and mechanical axis</u>				6°
<u>Wavelength at peak emission</u>	$\lambda_{\text{pk}}$	typ.	880	nm
<u>Bandwidth at half height</u>	$B_{50\%}$	typ.	40	nm
<u>Light rise time at <math>I_{F\text{on}} = 20 \text{ mA}</math></u>	$t_r$	typ.	30	ns
		<	100	ns
<u>Light fall time at <math>I_{F\text{on}} = 20 \text{ mA}</math></u>	$t_f$	typ.	30	ns
		<	100	ns

<sup>1)</sup> This corresponds typically with  $I_{\text{CEO(L)}} = 0,4 \text{ mA}$  in a phototransistor BPX25



7272112

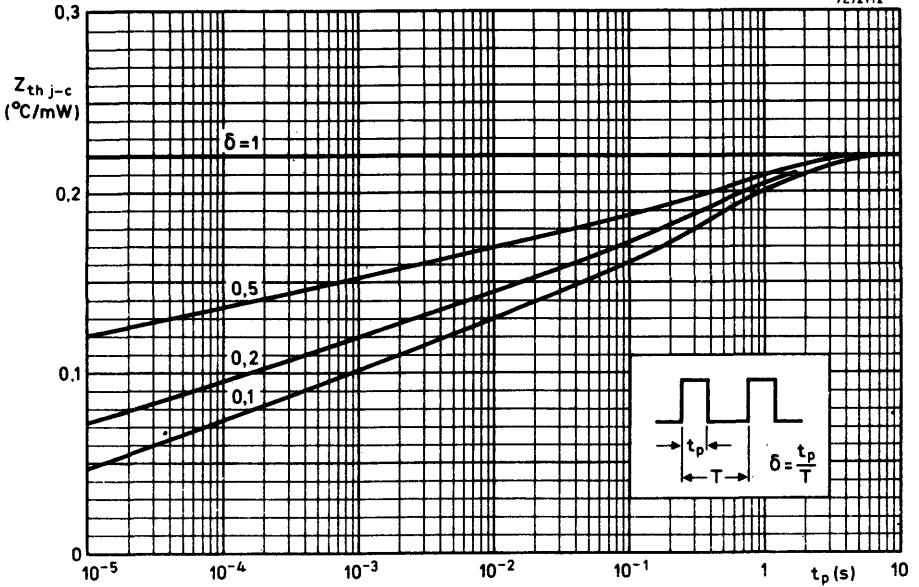

7272106

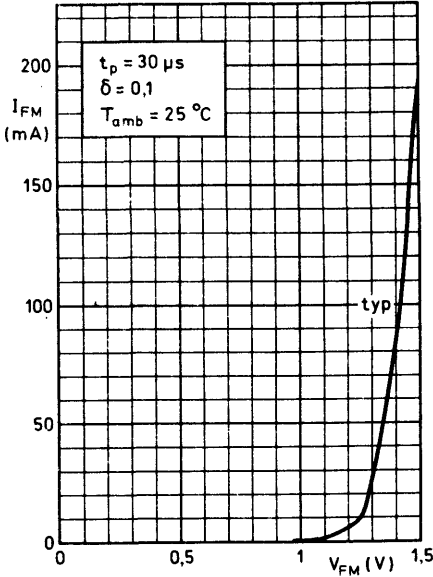

7272110

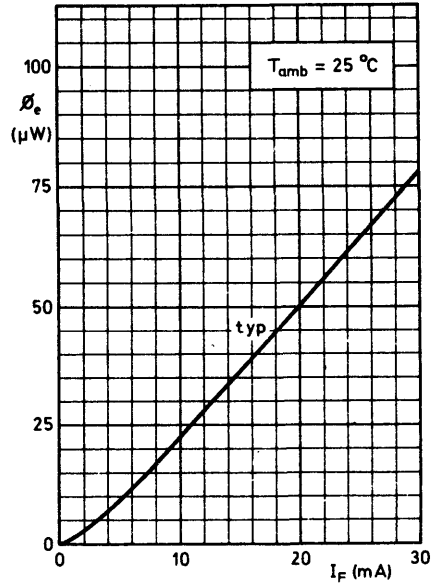

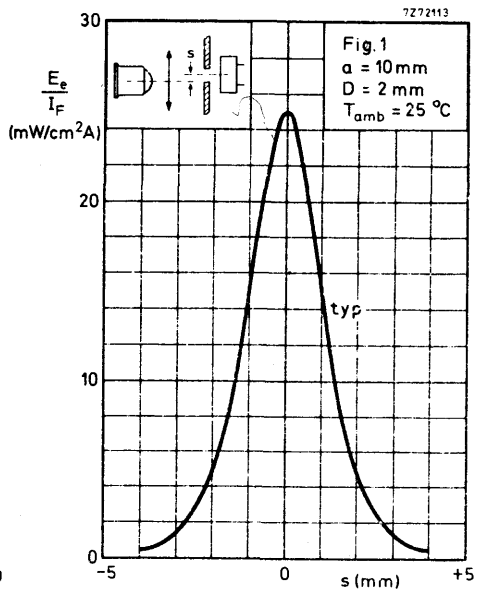
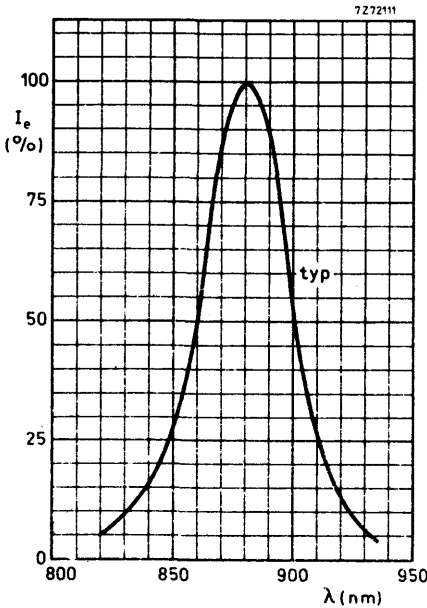
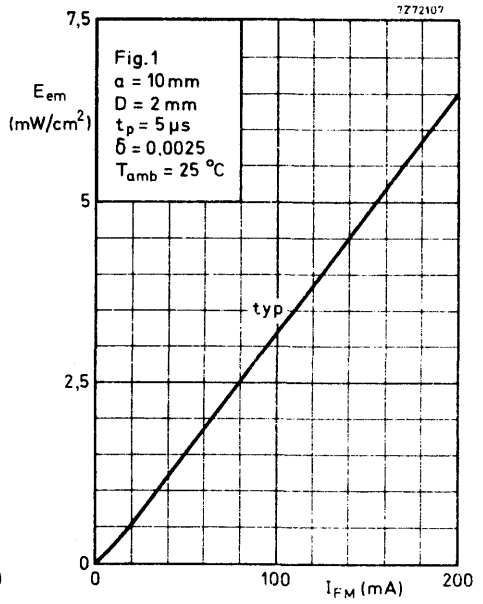
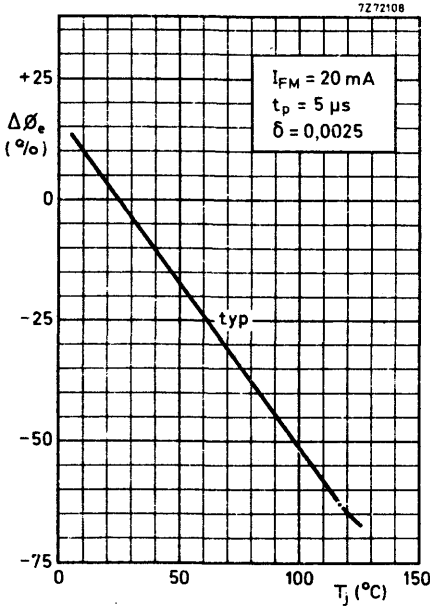

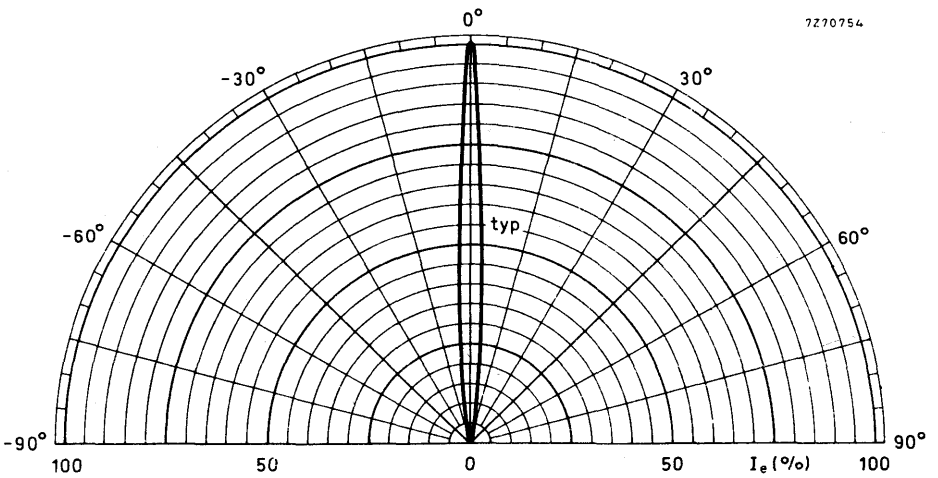
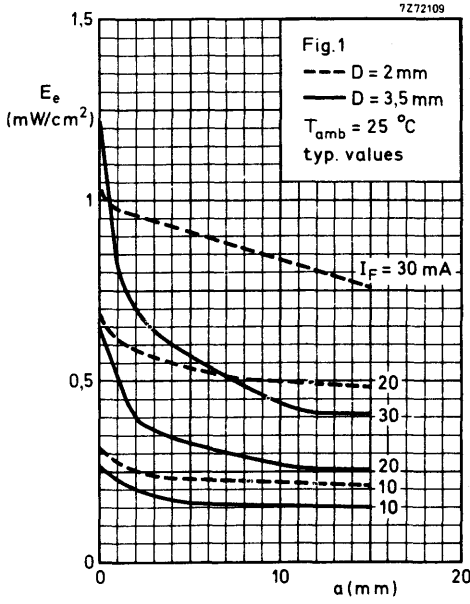

## GaAsP RED LIGHT EMITTING DIODE

Gallium arsenide phosphide light emitting diode which emits visible red light when forward biased. The envelope is of light-diffusing red plastic and the device has been designed for applications where space is at a premium, such as high density arrays.

### QUICK REFERENCE DATA

Continuous reverse voltage	$V_R$	max.	3	V
Forward current (d.c.)	$I_F$	max.	50	mA
Total power dissipation up to $T_{amb} = 37.5\text{ }^\circ\text{C}$	$P_{tot}$	max.	100	mW
Luminous intensity (on-axis) at $I_F = 20\text{ mA}$	$I_v$	min.	0.7	mcd
	$I_v$	typ.	1.5	mcd
Wavelength at peak emission	$\lambda_{pk}$	typ.	650	nm
Beamwidth between half-intensity directions	$\alpha_{50\%}$	typ.	55	degrees
Thermal resistance from junction to ambient	$R_{th\ j-a}$		0.625	$^\circ\text{C}/\text{mW}$

This data must be read in conjunction with GENERAL SAFETY RECOMMENDATIONS – OPTOELECTRONIC DEVICES

### PRODUCT SAFETY

Modern high technology materials have been used in the manufacture of this device to ensure high performance. Some of these materials are toxic in certain circumstances. Mechanical or electrical damage is unlikely to give rise to any hazard, but toxic vapours may be generated if the device is heated to destruction. Disposal of large quantities should therefore be carried out in accordance with the Deposit of Poisonous Waste Act 1972 and the Control of Pollution Act 1974, or with the latest legislation.

### MECHANICAL DATA

Dimensions in mm

SOD-63 (T-1¼)

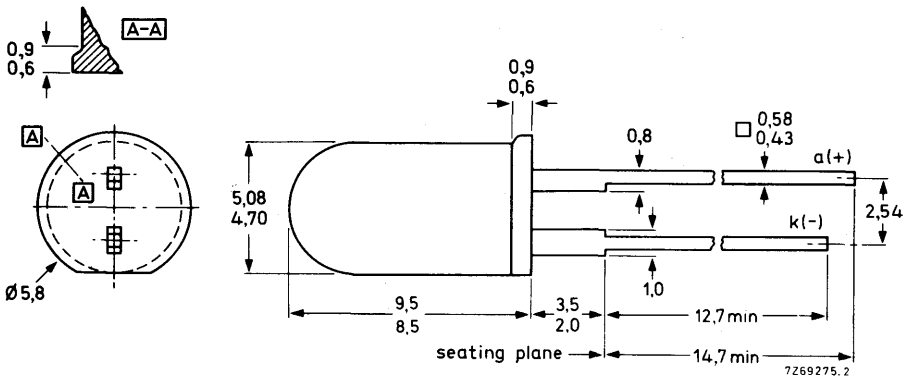

**ACCESSORIES**

For panel mounting (panel thickness < 4 mm)

Plastic clip and ring, black: type RTC757A

Hole diameter 6.4 mm for panel thickness < 3 mm  
6.5 mm for panel thickness > 3 mm

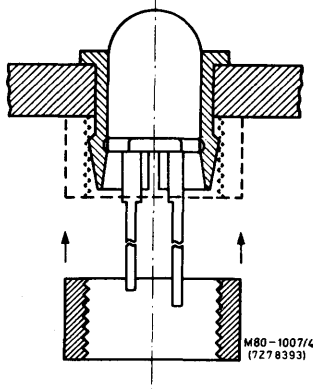
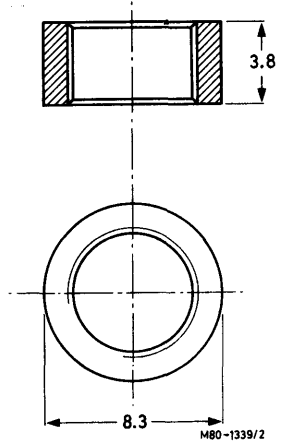
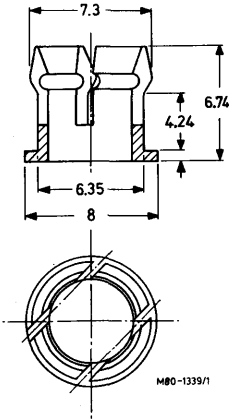



## RATINGS

Limiting values in accordance with the Absolute Maximum System (IEC 134)

Continuous reverse voltage	$V_R$	max.	3	V
Forward current (d.c.)	$I_F$	max.	50	mA
Forward current (peak value)				
$t_p = 1 \mu s, f = 300 \text{ Hz}$	$I_{FM}$	max.	1000	mA
Power dissipation up to $T_{amb} = 37,5 \text{ }^\circ\text{C}$	$P_{tot}$	max.	100	mW
Storage temperature	$T_{stg}$		-55 to +100	$^\circ\text{C}$
Junction temperature	$T_j$	max.	100	$^\circ\text{C}$
Soldering temperature, up to the seating plane, $t_{sld} < 10 \text{ s}$	$T_{sld}$	max.	260	$^\circ\text{C}$

## THERMAL RESISTANCE

From junction to ambient, in free air	$R_{th \text{ j-a}}$		0.625	$^\circ\text{C}/\text{mW}$
From junction to ambient, mounted on a printed circuit board	$R_{th \text{ j-a}}$		0.5	$^\circ\text{C}/\text{mW}$

## CHARACTERISTICS

 $T_j = 25 \text{ }^\circ\text{C}$ 

Forward voltage		typ.	1.7	V
$I_f = 20 \text{ mA}$	$V_F$	<	2.0	V
Negative temperature coefficient of $V_F$	$\frac{-\Delta V_F}{\Delta T_j}$	typ.	1.6	mV/ $^\circ\text{C}$
$I_F = 2.0 \text{ mA}$	$\frac{-\Delta V_F}{\Delta T_j}$	typ.	2.0	mV/ $^\circ\text{C}$

Reverse current				
$V_R = 3 \text{ V}$	$I_R$	<	100	$\mu\text{A}$

Diode capacitance				
$V_R = 0, f = 1 \text{ MHz}$	$C_d$	typ.	60	pF

Luminous intensity (on axis)\*

$I_F = 20 \text{ mA}, T_{amb} = 25 \text{ }^\circ\text{C}$	CQY24B-I	$I_v$	0.7 to 1.6	mcd
	CQY24B-II	$I_v$	1.0 to 2.2	mcd
	CQY24B-III	$I_v$	1.6 to 3.5	mcd
	CQY24B-IV	$I_v$	> 3.0	mcd

Wavelength at peak emission	$\lambda_{pk}$	typ.	650	nm
Bandwidth at half height	B50%	typ.	20	nm
Beamwidth between half intensity directions	$\alpha_{50\%}$	typ.	55	degrees

\*For applications using a number of devices in close proximity, thus requiring spreads of luminous intensity of less than 2.5 times, production is graded into groups indicated by suffixes. Specific groupings, subject to availability, may be obtained only by negotiation with the supplier.



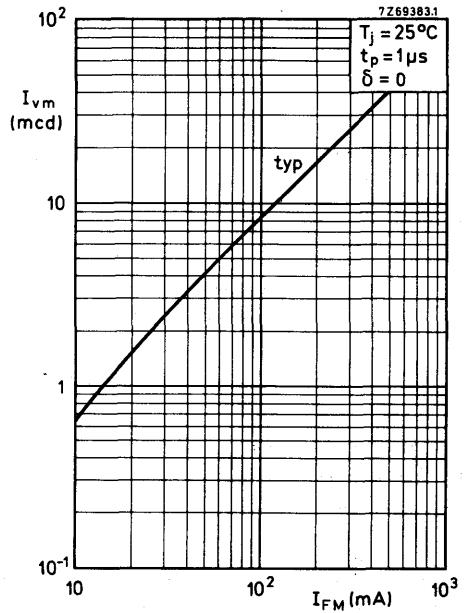
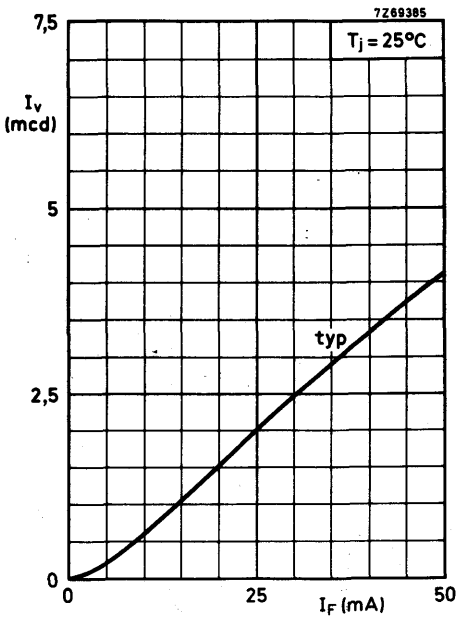
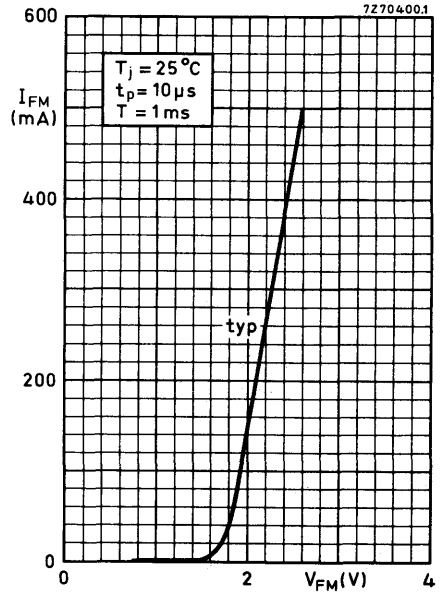
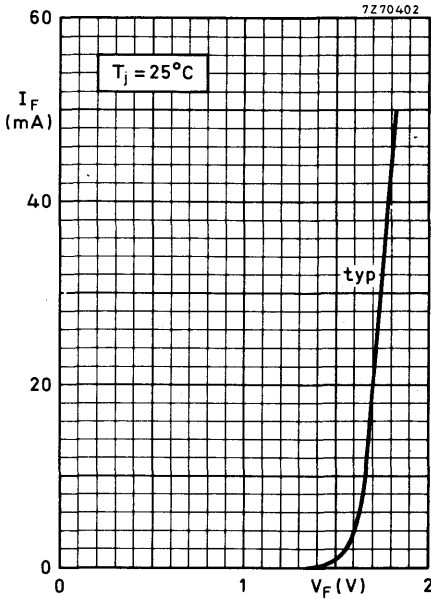

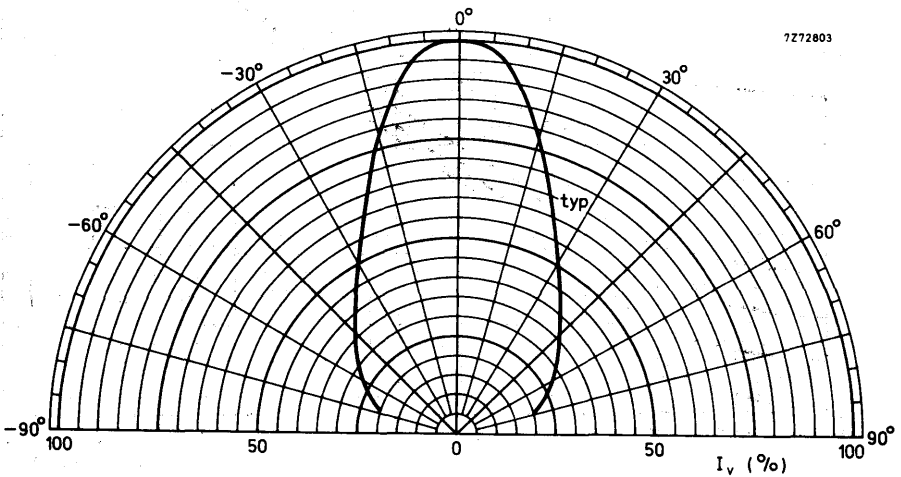
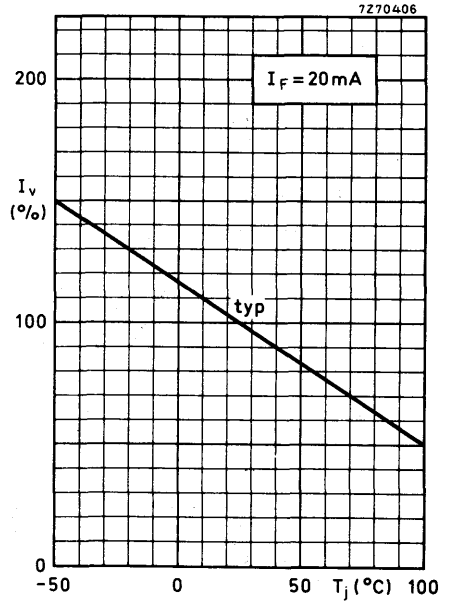
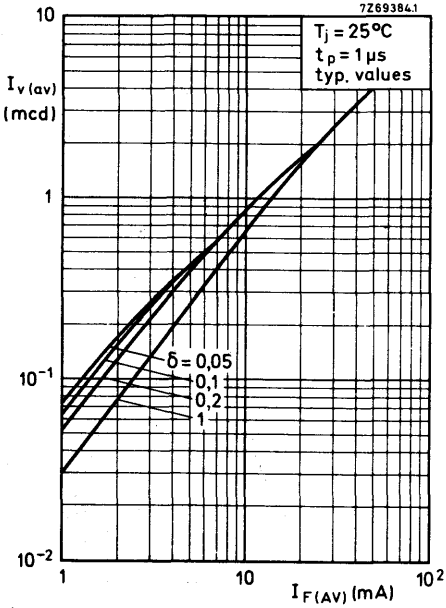

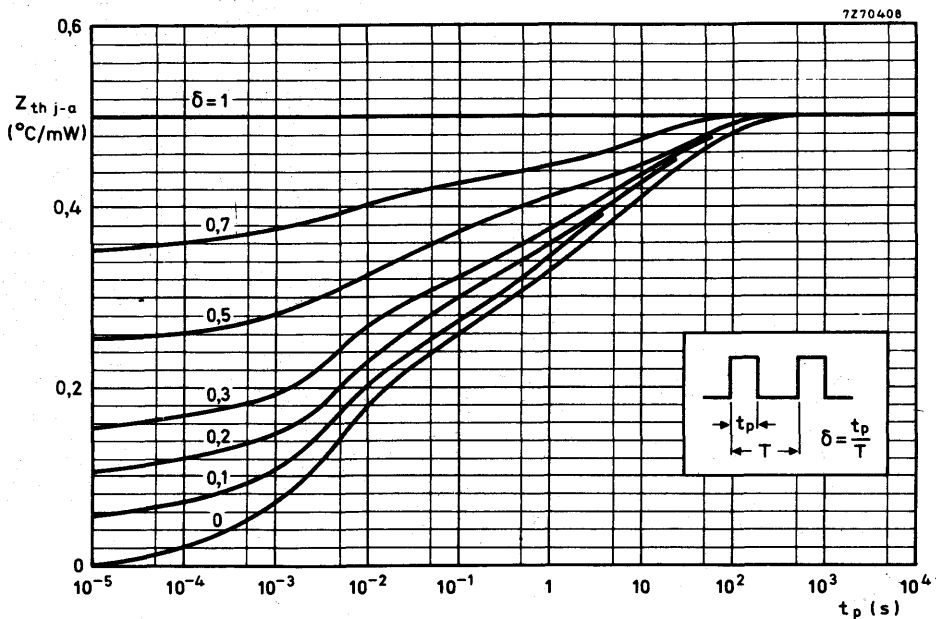
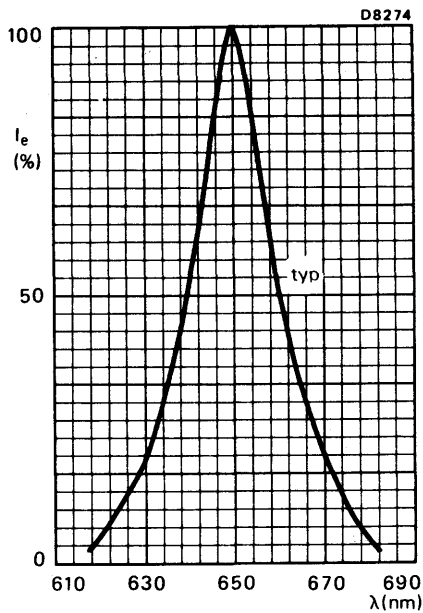
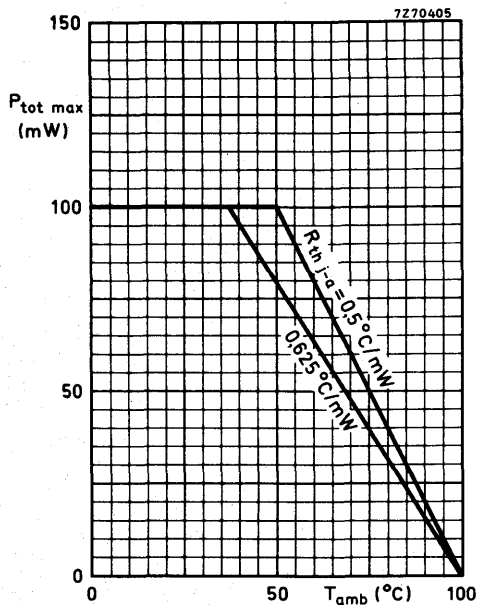

## GaAs LIGHT EMITTING DIODE

Epitaxial gallium arsenide light emitting diode intended for optical coupling and encoding. It emits radiation in the near infrared when forward biased. Envelope similar to TO-18. Suitable for combination with phototransistor BPX25.

### QUICK REFERENCE DATA

Continuous reverse voltage	$V_R$	max.	2 V
Forward current (d. c.)	$I_F$	max.	100 mA
Total power dissipation up to $T_{amb} = 25^\circ\text{C}$	$P_{tot}$	max.	150 mW
Radiant intensity (on-axis) at $I_F = 50\text{ mA}$	$I_e$	>	3 mW/sr
Wavelength at peak emission	$\lambda_{pk}$	typ.	930 nm
Thermal resistance from junction to ambient	$R_{th\ j-a}$	=	0,665 $^\circ\text{C}/\text{mW}$

This data must be read in conjunction with GENERAL SAFETY RECOMMENDATIONS – OPTOELECTRONIC DEVICES

### PRODUCT SAFETY

Modern high technology materials have been used in the manufacture of this device to ensure high performance. Some of these materials are toxic in certain circumstances. Mechanical or electrical damage is unlikely to give rise to any hazard, but toxic vapours may be generated if the device is heated to destruction. Disposal of large quantities should therefore be carried out in accordance with the Deposit of Poisonous Waste Act 1972 and the Control of Pollution Act 1974, or with the latest legislation.

### MECHANICAL DATA

Dimensions in mm

TO-18 except for lens

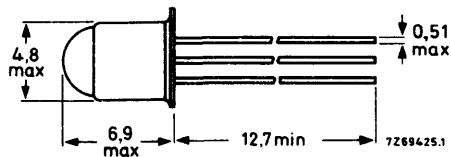
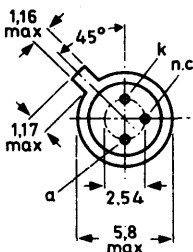

**RATINGS** Limiting values in accordance with the Absolute Maximum System (IEC 134)

Voltage

Continuous reverse voltage  $V_R$  max. 2 V

Current

Forward current (d. c.)  $I_F$  max. 100 mA

Forward current (peak value)  
 $t_p < 10 \mu s; \delta < 0,01$   $I_{FM}$  max. 1 A

Power dissipation

Total power dissipation up to  $T_{amb} = 25 \text{ }^\circ\text{C}$   $P_{tot}$  max. 150 mW

Temperature

Storage temperature  $T_{stg}$  -40 to +100  $^\circ\text{C}$

Operating junction temperature  $T_j$  max. 125  $^\circ\text{C}$

Lead soldering temperature  
 $> 1,5 \text{ mm}$  from the body;  $t_{sld} < 10 \text{ s}$   $T_{sld}$  max. 260  $^\circ\text{C}$

**THERMAL RESISTANCE**

From junction to ambient in free air  $R_{th j-a} = 0,665 \text{ }^\circ\text{C/mW}$

From junction to case  $R_{th j-c} = 0,3 \text{ }^\circ\text{C/mW}$



## CHARACTERISTICS

 $T_j = 25\text{ }^\circ\text{C}$  unless otherwise specifiedForward voltage at  $I_F = 50\text{ mA}$ 

$V_F$	typ.	1, 3	V
	<	1, 5	V

Reverse current at  $V_R = 2\text{ V}$ 

$I_R$	<	100	$\mu\text{A}$
-------	---	-----	---------------

Diode capacitance $V_R = 0; f = 1\text{ MHz}$ 

$C_d$	typ.	55	pF
-------	------	----	----

Radiant intensity (on-axis) at  $I_F = 50\text{ mA}$ 

$I_e$	>		3 mW/sr
	typ.		5 mW/sr

Wavelength at peak emission

$\lambda_{pk}$	typ.	930	nm
----------------	------	-----	----

Bandwidth at half height

$B_{50\%}$	typ.	50	nm
------------	------	----	----

Beamwidth between half-intensity directions

$\alpha_{50\%}$	typ.		$15^\circ$
-----------------	------	--	------------

Angle between optical and mechanical axis

	typ.		$6^\circ$
--	------	--	-----------

Switching times $I_{Fon} = 50\text{ mA}; t_p = 2\text{ }\mu\text{s}; f = 45\text{ kHz}$ 

Light rise time

$t_r$	typ.	600	ns
-------	------	-----	----

Light fall time

$t_f$	typ.	350	ns
-------	------	-----	----



# CQY49C

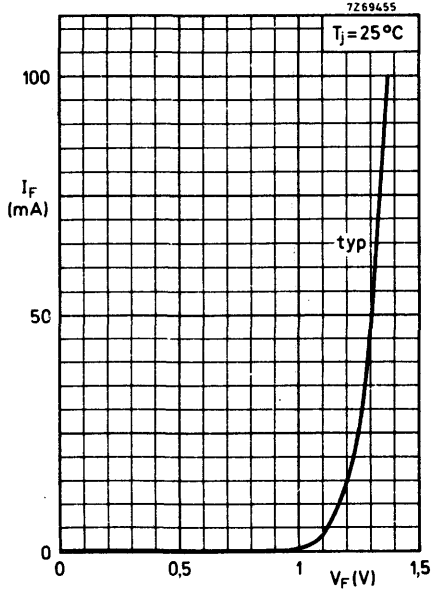
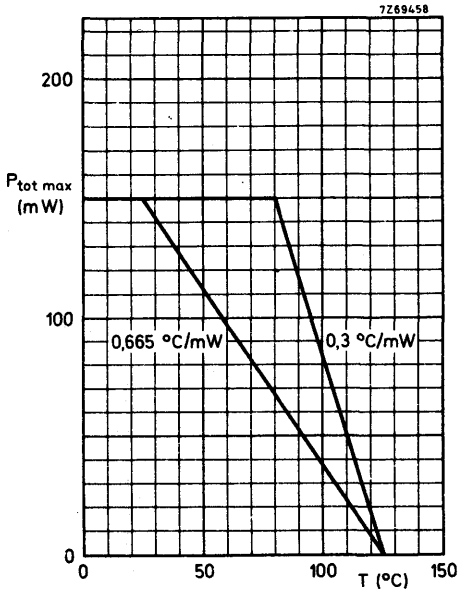
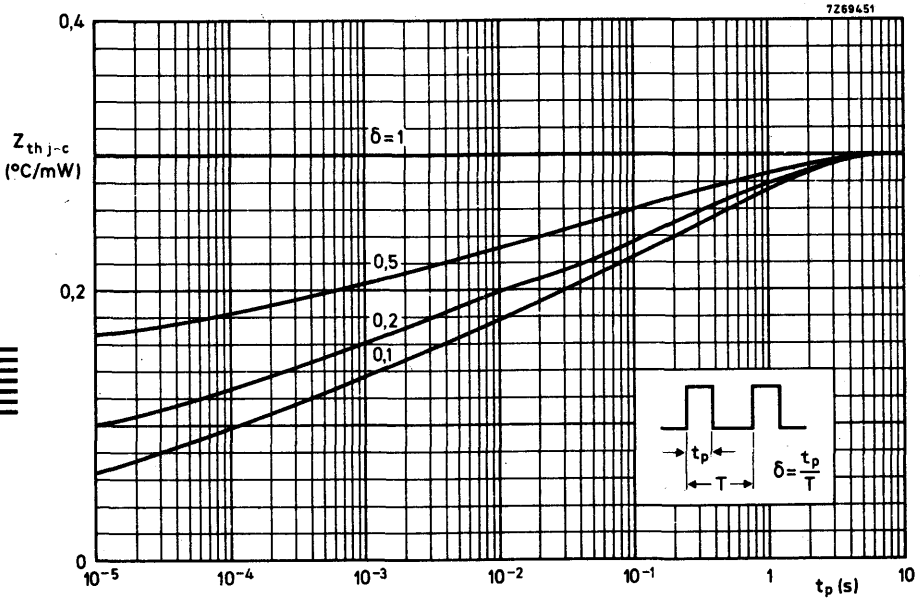



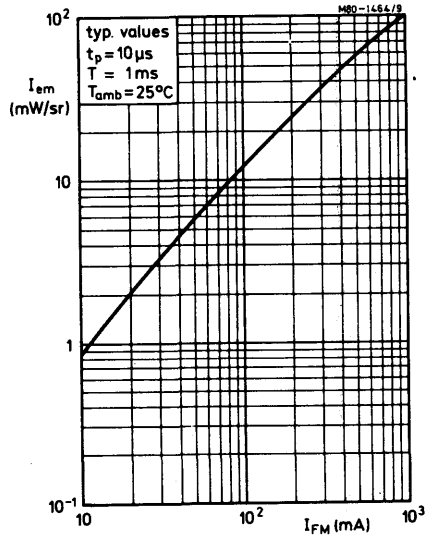
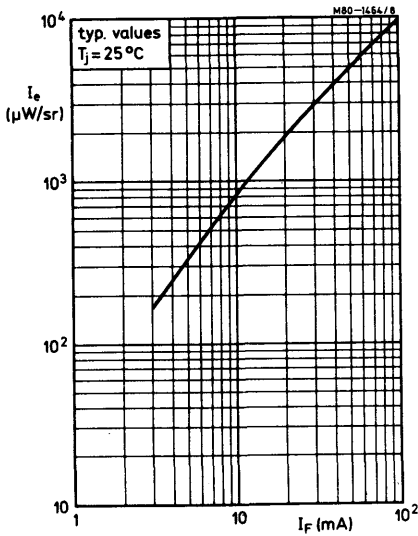
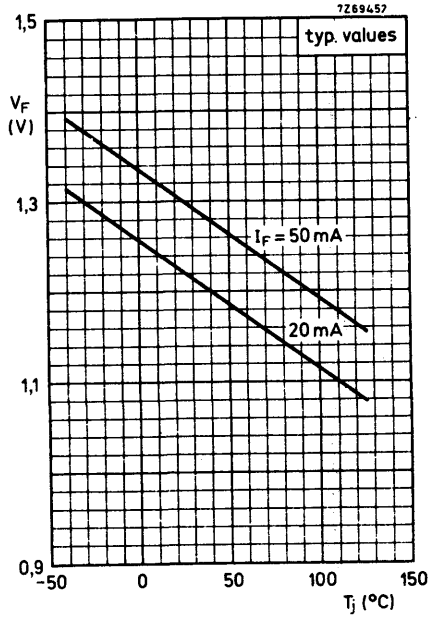
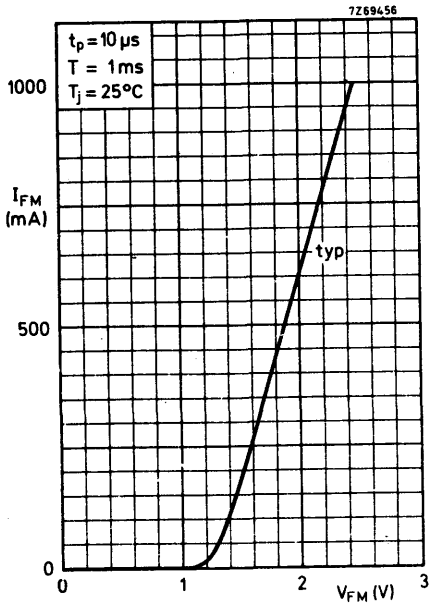

# CQY49C

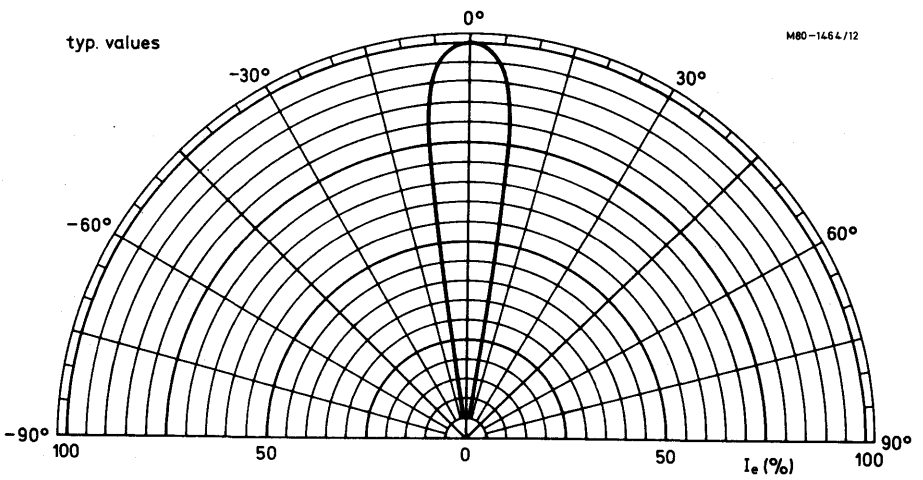
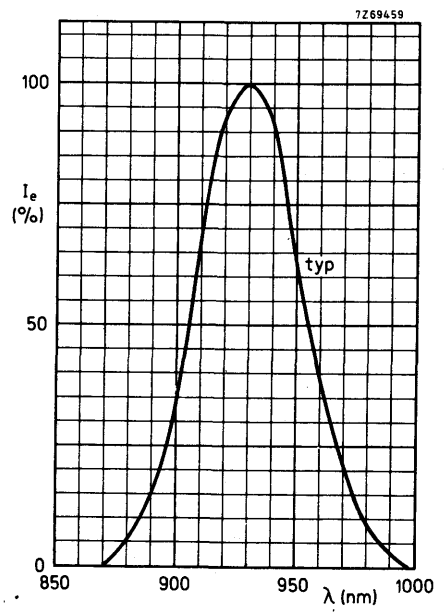
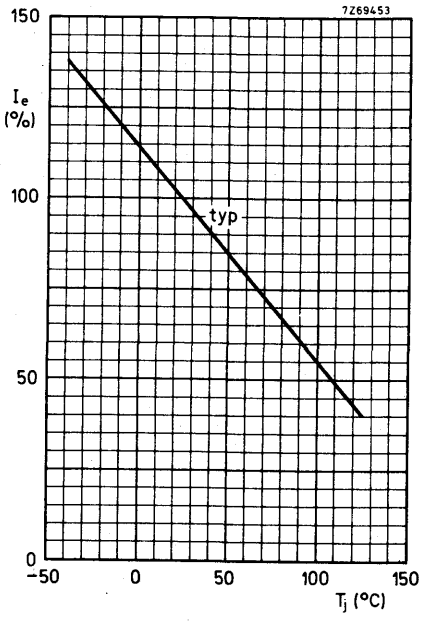

## GaAs LIGHT EMITTING DIODES

Gallium arsenide light emitting diodes which emit near-infrared light when forward biased. Ceramic-metal envelope with glass lens suitable for matrix layout on printed circuit boards. In conjunction with a suitable phototransistor also suitable for punched card reading.

## QUICK REFERENCE DATA

Continuous reverse voltage	$V_R$	max.	2	V				
Forward current (d. c.)	$I_F$	max.	100	mA				
Total power dissipation up to $T_{amb} = 25\text{ }^\circ\text{C}$ mounted on printed circuit board	$P_{tot}$	max.	150	mW				
Total radiant power at $I_F = 20\text{ mA}$	$\phi_e$	>	<table border="1" style="display: inline-table; vertical-align: middle;"><thead><tr><th>CQY50</th><th>CQY52</th></tr></thead><tbody><tr><td>160</td><td>400</td></tr></tbody></table>	CQY50	CQY52	160	400	$\mu\text{W}$
CQY50	CQY52							
160	400							
Radiant intensity (on-axis) at $I_F = 20\text{ mA}$	$I_e$	>	<table border="1" style="display: inline-table; vertical-align: middle;"><thead><tr><th>CQY50</th><th>CQY52</th></tr></thead><tbody><tr><td>180</td><td>450</td></tr></tbody></table>	CQY50	CQY52	180	450	$\mu\text{W/sr}$
CQY50	CQY52							
180	450							
Wavelength at peak emission	$\lambda_{pk}$	typ.	930	nm				

This data must be read in conjunction with GENERAL SAFETY RECOMMENDATIONS – OPTOELECTRONIC DEVICES

## PRODUCT SAFETY

Modern high technology materials have been used in the manufacture of this device to ensure high performance. Some of these materials are toxic in certain circumstances. Mechanical or electrical damage is unlikely to give rise to any hazard, but toxic vapours may be generated if the device is heated to destruction. Disposal of large quantities should therefore be carried out in accordance with the Deposit of Poisonous Waste Act 1972 and the Control of Pollution Act 1974, or with the latest legislation.

## MECHANICAL DATA

Dimensions in mm

DO-31 except for length

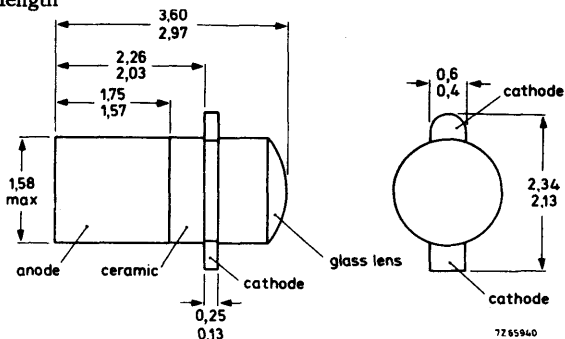

CQY50

CQY52

**RATINGS** Limiting values in accordance with the Absolute Maximum System (IEC 134)

Voltage

Continuous reverse voltage  $V_R$  max. 2 V

Current

Forward current (d. c.)  $I_F$  max. 100 mA

Forward current (peak value)  
 $t_p = 10 \mu s; \delta = 0,01$   $I_{FM}$  max. 500 mA

Temperature

Storage temperature  $T_{stg}$  -65 to +150 °C

Operating junction temperature  $T_j$  max. 125 °C

Power dissipation

Total power dissipation up to  $T_{amb} = 25 \text{ }^\circ\text{C}$   
device mounted on p. c. board <sup>1)</sup>  $P_{tot}$  max. 150 mW

**THERMAL RESISTANCE**

From junction to ambient,  
device mounted on p. c. board <sup>1)</sup>  $R_{th j-a} = 0,66 \text{ }^\circ\text{C/mW}$

<sup>1)</sup> With copper islands of 6 x 2 mm on both sides of 1,6 mm glass-epoxy printed circuit board; thickness of copper 35  $\mu m$ .



**CHARACTERISTICS** $T_{amb} = 25^{\circ}\text{C}$  unless otherwise specified

		CQY50	CQY52	
<u>Forward voltage</u>				
$I_F = 50 \text{ mA}$	$V_F$ typ.	1,3	1,3	V
	$V_F$ <	1,5	1,5	V
$I_F = 500 \text{ mA}; t_p = 10 \mu\text{s}; \delta = 0,01$	$V_F$ typ.	2,3	2,3	V
<u>Reverse current</u>				
$V_R = 2 \text{ V}$	$I_R$ <	100	100	$\mu\text{A}$
<u>Diode capacitance</u>				
$V_R = 0; f = 1 \text{ MHz}$	$C_d$ typ.	45	45	pF
<u>Total radiant power</u>				
$I_F = 20 \text{ mA}$	$\phi_e$ >	160	400	$\mu\text{W}$
$I_F = 50 \text{ mA}$	$\phi_e$ typ.	700	1500	$\mu\text{W}$
<u>Radiant intensity (on-axis)</u>				
$I_F = 20 \text{ mA}$	$I_e$ >	180	450	$\mu\text{W}/\text{sr}$
<u>Wavelength at peak emission</u>				
	$\lambda_{pk}$ typ.	930	930	nm
<u>Bandwidth at half height</u>				
	$B_{50\%}$ typ.	40	40	nm
<u>Beamwidth between half-intensity directions</u>				
	$\alpha_{50\%}$ typ.	$35^{\circ}$	$35^{\circ}$	
<u>Switching times</u>				
$I_{Fon} = 20 \text{ mA}; t_p = 2 \mu\text{s}; f = 45 \text{ kHz}$				
Light rise time	$t_r$ typ.	600	600	ns
Light fall time	$t_f$ typ.	350	350	ns



CQY50

CQY52

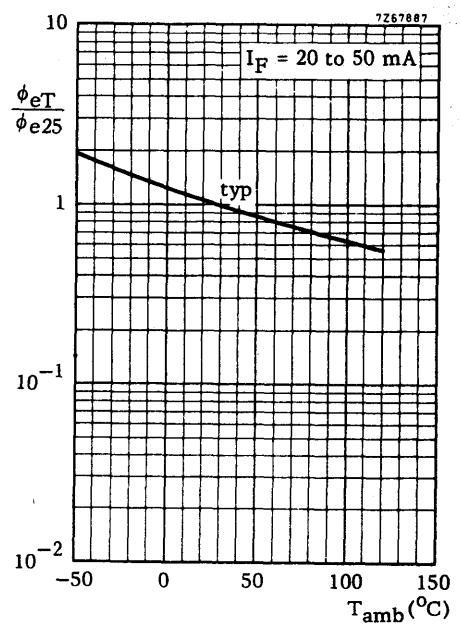
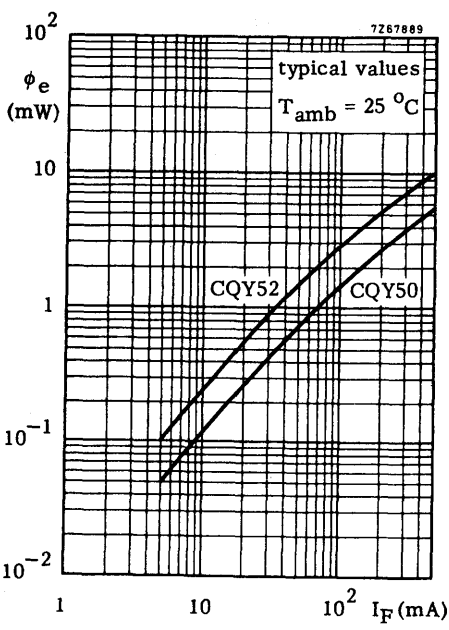
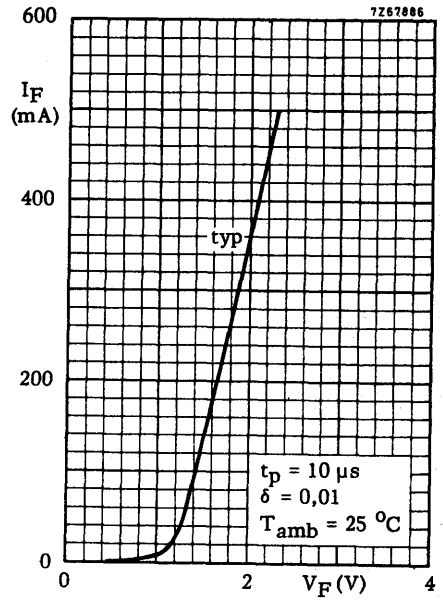
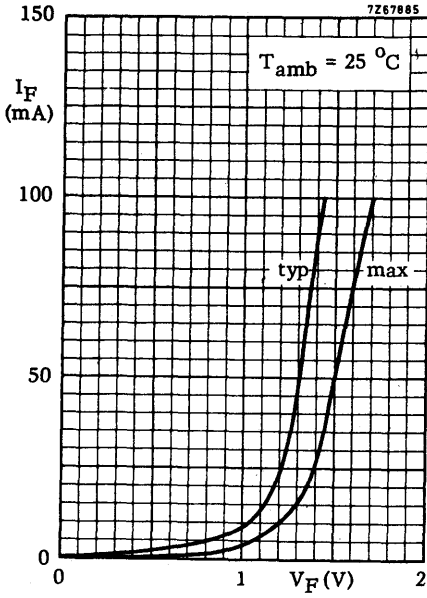

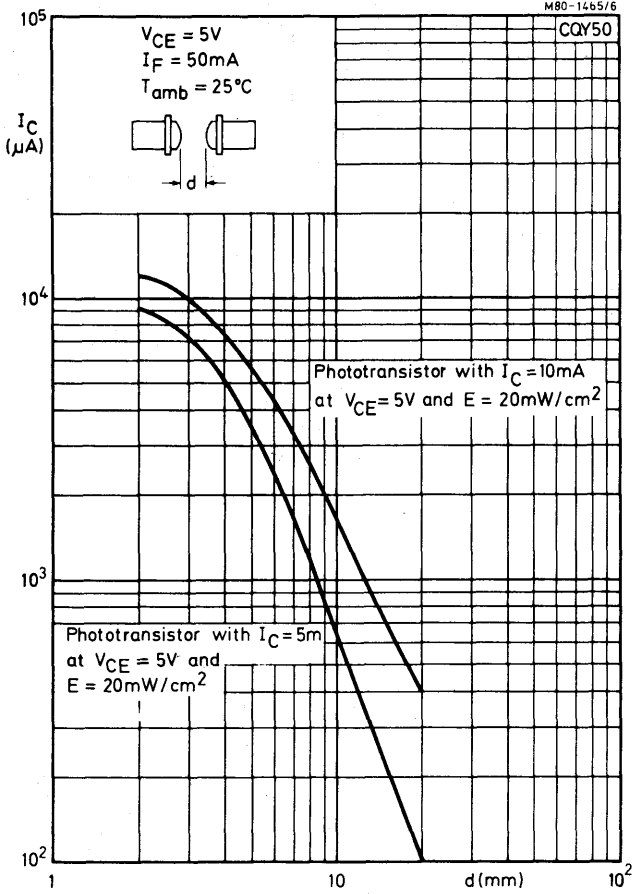

CQY50

CQY52

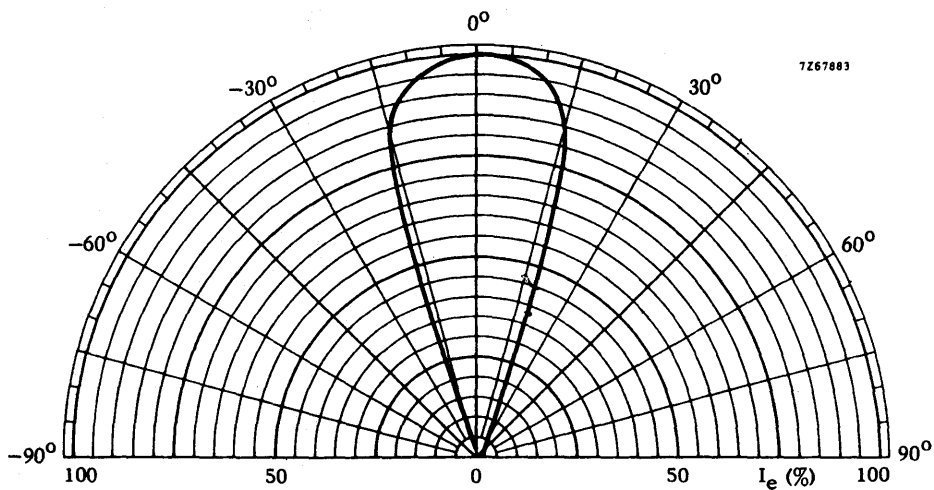
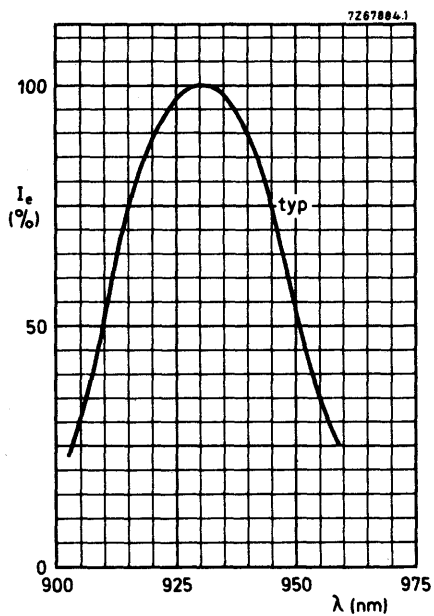
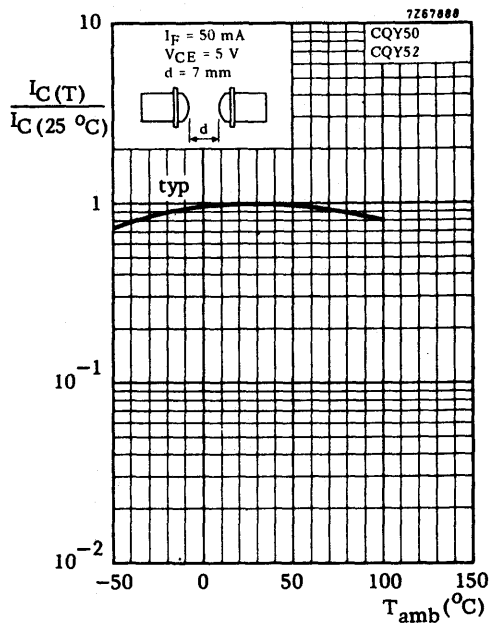



## GaAsP RED LIGHT EMITTING DIODE

Gallium arsenide phosphide light emitting diode which emits visible red light when forward biased. The envelope is of light-diffusing red plastic, and has been designed for high-density arrays.

### QUICK REFERENCE DATA

Continuous reverse voltage	$V_R$	max.	3 V
Forward current (d.c.)	$I_F$	max.	50 mA
Total power dissipation up to $T_{amb} = 37,5^\circ\text{C}$	$P_{tot}$	max.	100 mW
Luminous intensity (on-axis) at $I_F = 20\text{ mA}$	$I_v$	min.	0.3 mcd
$I_F = 20\text{ mA}$	$I_v$	typ.	0.9 mcd

Wavelength at peak emission

Beamwidth between half-intensity directions

This data must be read in conjunction with GENERAL SAFETY RECOMMENDATIONS – OPTOELECTRONIC DEVICES

### PRODUCT SAFETY

Modern high technology materials have been used in the manufacture of this device to ensure high performance. Some of these materials are toxic in certain circumstances. Mechanical or electrical damage is unlikely to give rise to any hazard, but toxic vapours may be generated if the device is heated to destruction. Disposal of large quantities should therefore be carried out in accordance with the Deposit of Poisonous Waste Act 1972 and the Control of Pollution Act 1974, or with the latest legislation.

### MECHANICAL DATA

Dimensions in mm

Fig. 1 SOD-53C (T-1)

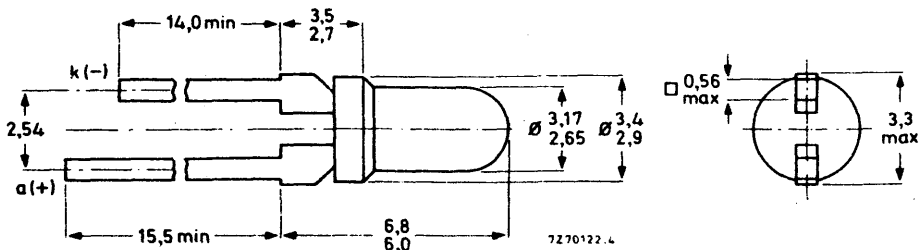

**RATINGS**

Limiting values in accordance with the Absolute Maximum System (IEC 134)

Continuous reverse voltage	$V_R$	max.	3 V
Forward current (d.c.)	$I_F$	max.	50 mA
Forward current (peak value) $t_p = 1 \mu s; f = 300 \text{ Hz}$	$I_{FM}$	max.	1000 mA
Storage temperature	$T_{stg}$		-55 to +100 °C
Junction temperature	$T_j$	max.	100 °C
Total power dissipation up to $T_{amb} = 37,5 \text{ °C}$	$P_{tot}$	max.	100 mW

**THERMAL RESISTANCE**

From junction to ambient,  
in free air  
mounted on a p.c. board

$R_{th j-a}$	=	0,625 °C/mW
$R_{th j-a}$	=	0,500 °C/mW



## CHARACTERISTICS

 $T_j = 25\text{ }^\circ\text{C}$ 

Forward voltage

 $I_F = 20\text{ mA}$ Negative temperature coefficient of  $V_F$  $I_F = 20\text{ mA}$ 

Reverse current

 $V_R = 3\text{ V}$ 

Luminous intensity (on-axis)

 $I_F = 20\text{ mA}$ 

Diode capacitance

 $V_R = 0; F = 1\text{ MHz}$ 

Wavelength at peak emission

Bandwidth at half height

Beamwidth between half-intensity directions

$V_F$	typ.	1,7 V
	<	2,0 V

$\frac{-\Delta V_F}{\Delta T_j}$	typ.	1,6 mV/°C
----------------------------------	------	-----------

$\frac{-\Delta V_F}{\Delta T_j}$	typ.	2 mV/°C
----------------------------------	------	---------

$I_R$	<	100 $\mu\text{A}$
-------	---	-------------------

CQY54

$I_v$	>	0,3 mcd
-------	---	---------

CQY54-I

$I_v$		0,7 to 1,6 mcd
-------	--	----------------

CQY54-II

$I_v$		1 to 2,2 mcd
-------	--	--------------

CQY54-III

$I_v$	>	1,6 mcd
-------	---	---------

$C_d$	typ.	60 pF
-------	------	-------

$\lambda_{pk}$	typ.	650 nm
----------------	------	--------

$B_{50\%}$	typ.	20 nm
------------	------	-------

$\alpha_{50\%}$	typ.	80°
-----------------	------	-----

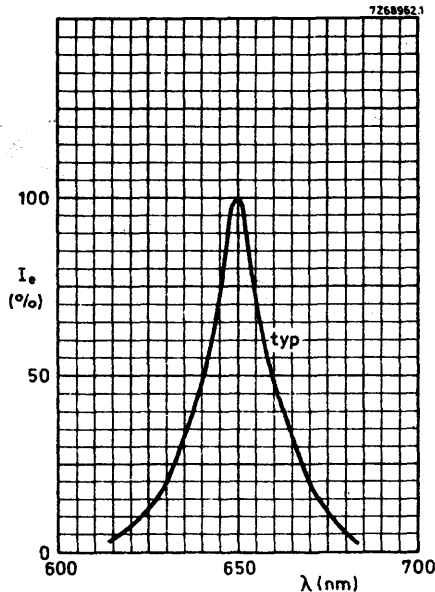
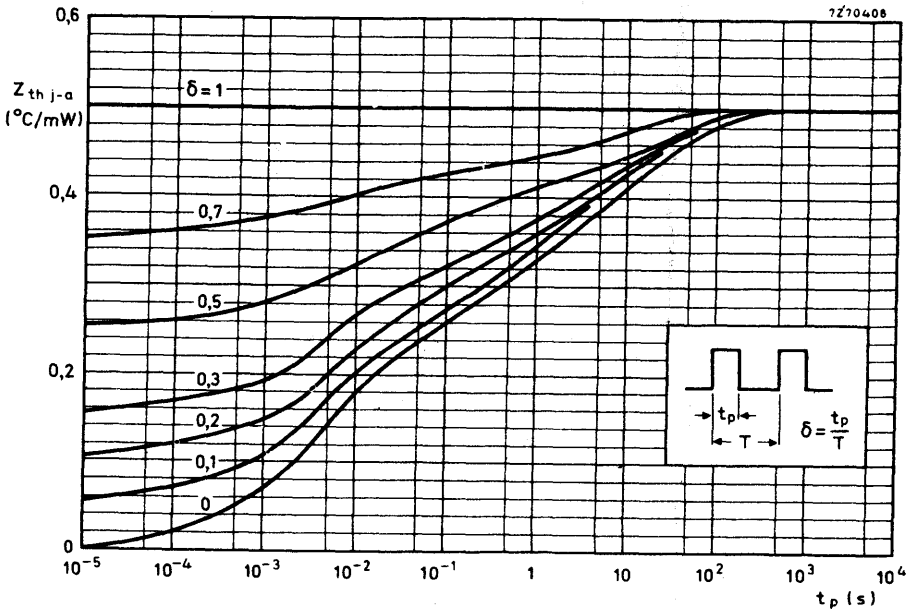
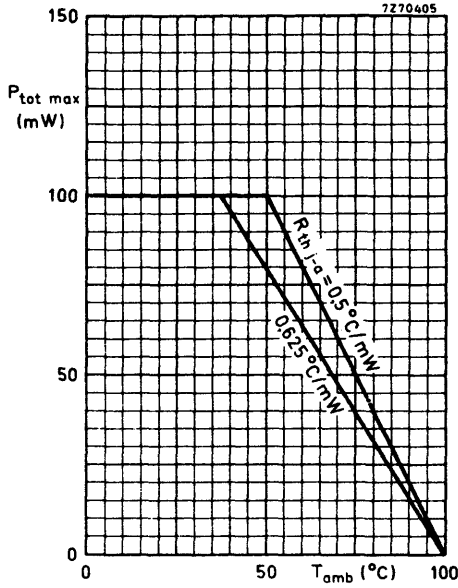
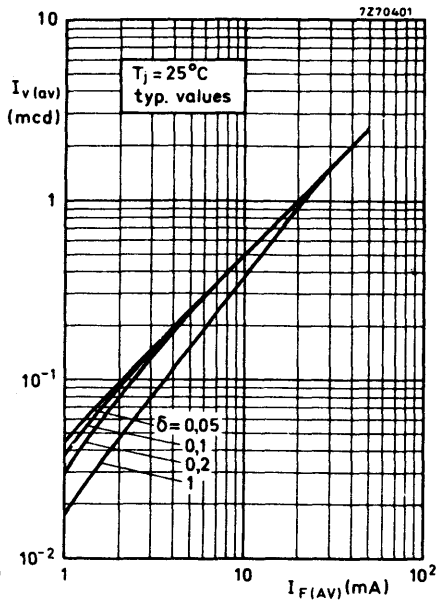
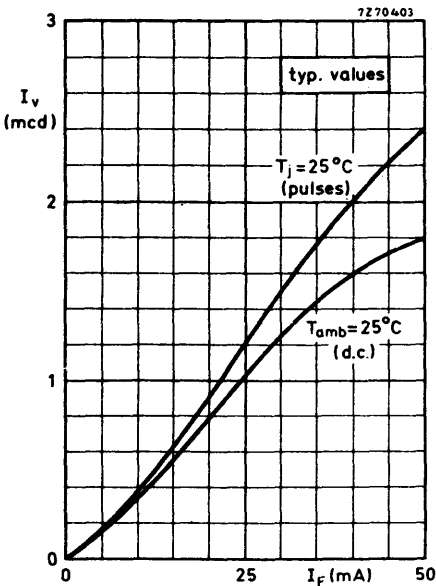
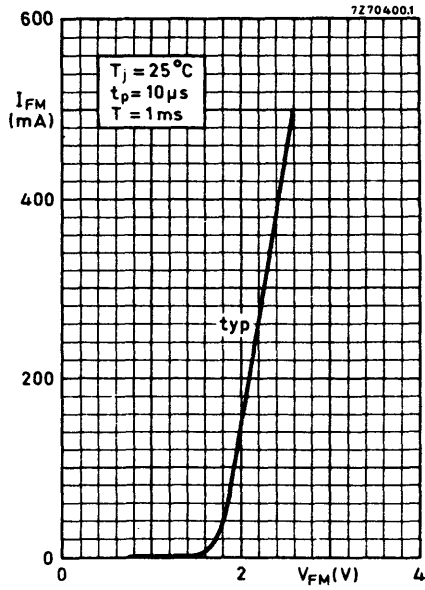
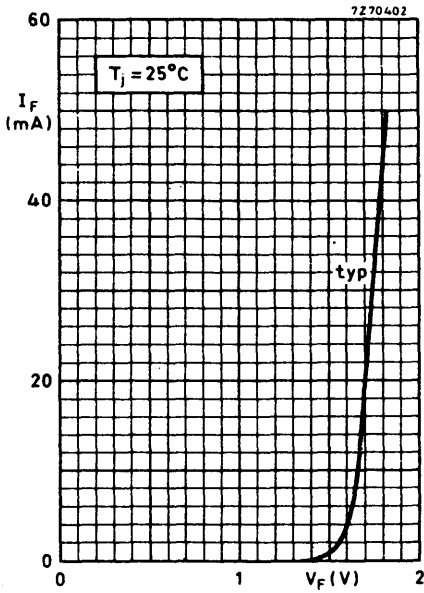
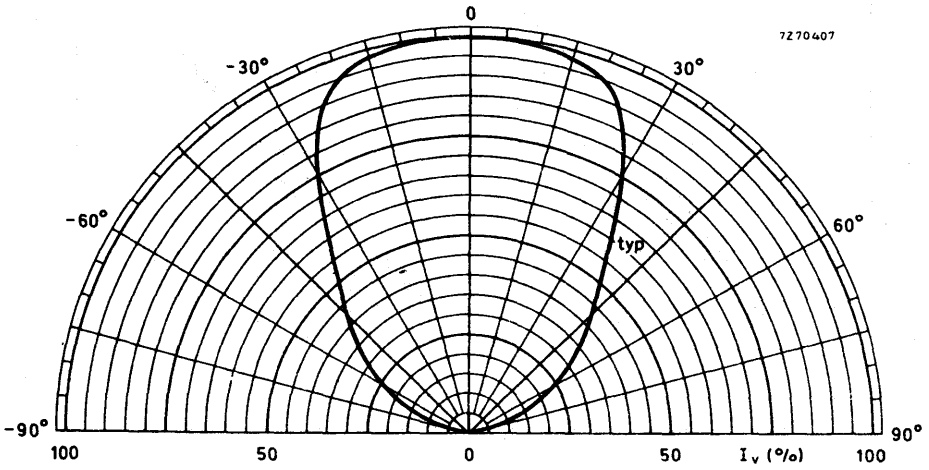
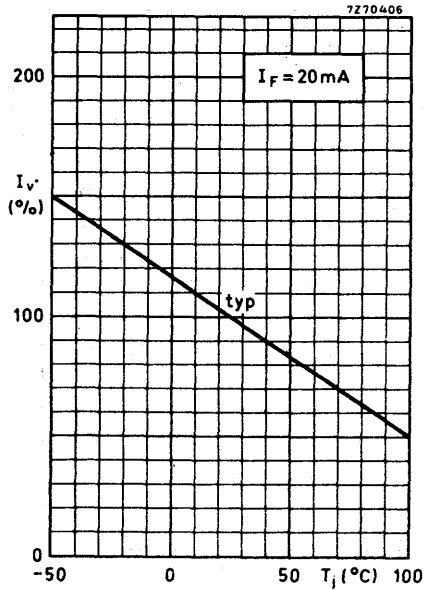
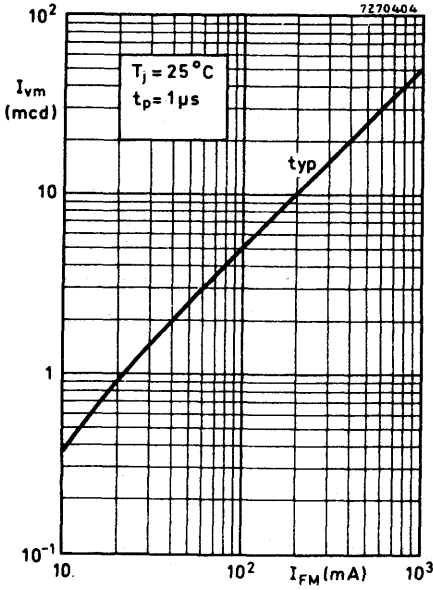

Fig. 2.









### GaAs LIGHT EMITTING DIODE

Diffused planar light emitting diode intended for optical coupling and encoding. It emits radiation in the near infrared when forward biased. Infrared translucent epoxy encapsulation (dark blue). Combination with phototransistor BPW22A is recommended.

#### QUICK REFERENCE DATA

Continuous reverse voltage	$V_R$	max.	5 V
Forward current (d.c.)	$I_F$	max.	50 mA
Total power dissipation up to $T_{amb} = 25 \text{ }^\circ\text{C}$	$P_{tot}$	max.	100 mW
Radiant intensity (on-axis) at $I_F = 20 \text{ mA}$	$I_e$	>	1 mW/sr
Wavelength at peak emission	$\lambda_{pk}$	typ.	930 nm

This data must be read in conjunction with GENERAL SAFETY RECOMMENDATIONS – OPTOELECTRONIC DEVICES

#### PRODUCT SAFETY

Modern high technology materials have been used in the manufacture of this device to ensure high performance. Some of these materials are toxic in certain circumstances. Mechanical or electrical damage is unlikely to give rise to any hazard, but toxic vapours may be generated if the device is heated to destruction. Disposal of large quantities should therefore be carried out in accordance with the Deposit of Poisonous Waste Act 1972 and the Control of Pollution Act 1974, or with the latest legislation.

#### MECHANICAL DATA

Fig. 1 SOD-53D (T-1)

Dimensions in mm

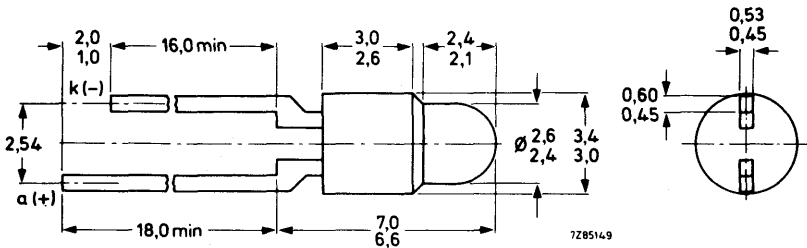

**RATINGS**

Limiting values in accordance with the Absolute Maximum System (IEC 134)

Continuous reverse voltage	$V_R$	max.	5 V
Forward current			
d.c.	$I_F$	max.	50 mA
(peak value); $t_p = 10 \mu s$ ; $\delta = 0,01$	$I_{FM}$	max.	200 mA
Total power dissipation up to $T_{amb} = 25 \text{ }^\circ\text{C}$ (see Fig. 2)	$P_{tot}$	max.	100 mW
Storage temperature	$T_{stg}$		-55 to +100 $^\circ\text{C}$
Junction temperature	$T_j$	max.	100 $^\circ\text{C}$
Lead soldering temperature			
> 3,5 mm from the body; $t_{sld} < 7 \text{ s}$	$T_{sld}$	max.	260 $^\circ\text{C}$

**THERMAL RESISTANCE**

From junction to ambient, device mounted on a printed-circuit board	$R_{th\ j-a}$	=	750 $^\circ\text{C/W}$
--	---------------	---	------------------------

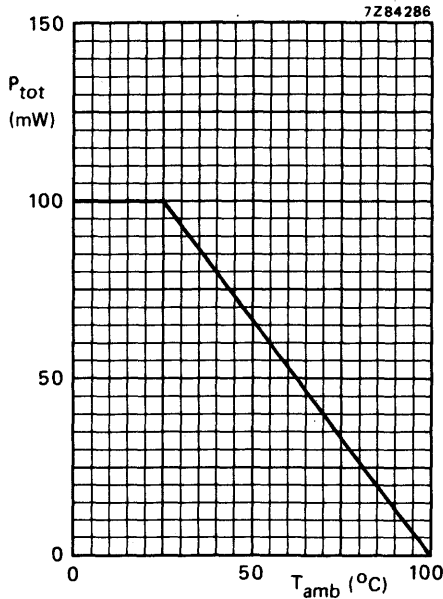

Fig. 2 Power derating curve versus ambient temperature.





## CHARACTERISTICS

 $T_j = 25\text{ }^\circ\text{C}$ 

Forward voltage

 $I_F = 20\text{ mA}$ 

$V_F$	typ.	1,2 V
	<	1,5 V

Reverse current

 $V_R = 5\text{ V}$ 

$I_R$	<	100 $\mu\text{A}$
-------	---	-------------------

Diode capacitance

 $V_R = 0; f = 1\text{ MHz}$ 

$C_d$	typ.	40 pF
-------	------	-------

Total radiant power

 $I_F = 20\text{ mA}$ 

$\phi_e$	typ.	1 mW
----------	------	------

Radiant intensity (on-axis)

 $I_F = 20\text{ mA}$ 

$I_e$	>	1 mW/sr
-------	---	---------

Wavelength at peak emission

$\lambda_{pk}$	typ.	930 nm
----------------	------	--------

Bandwidth at half height

$B_{50\%}$	typ.	50 nm
------------	------	-------

Beamwidth between half-intensity directions

 $I_F = 20\text{ mA}$ 

$\alpha_{50\%}$	typ.	$\pm 10^\circ$
-----------------	------	----------------

Switching times

 $I_{Fon} = 20\text{ mA}$ 

Light rise time

$t_r$	typ.	3 $\mu\text{s}$
-------	------	-----------------

Light fall time

$t_f$	typ.	3 $\mu\text{s}$
-------	------	-----------------



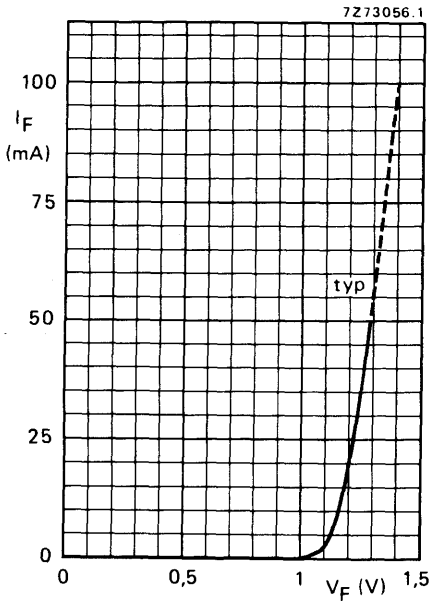

Fig. 3  $T_{amb} = 25\text{ }^\circ\text{C}$ .

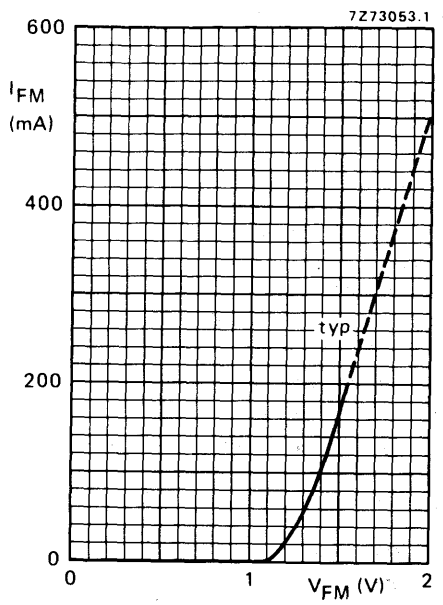

Fig. 4  $t_p = 10\text{ }\mu\text{s}$ ;  $T = 1\text{ ms}$ ;  $T_{amb} = 25\text{ }^\circ\text{C}$ .

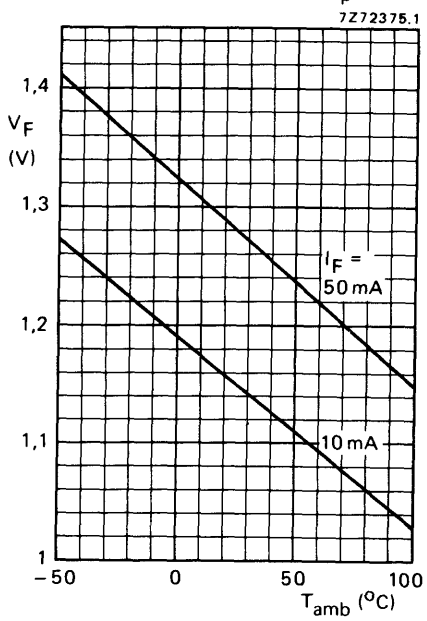

Fig. 5 Typical values.



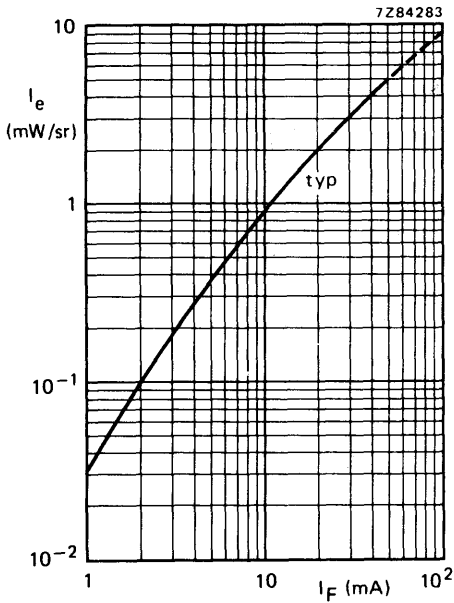

Fig. 6  $T_{amb} = 25\text{ }^\circ\text{C}$ .

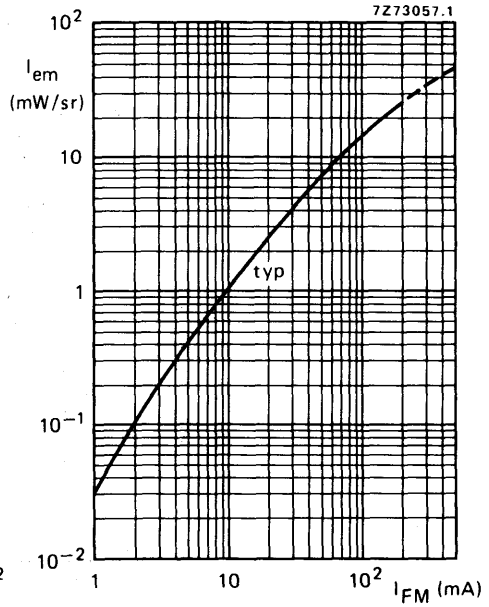

Fig. 7  $t_p = 10\text{ }\mu\text{s}$ ;  $T = 1\text{ ms}$ ;  $T_{amb} = 25\text{ }^\circ\text{C}$ .

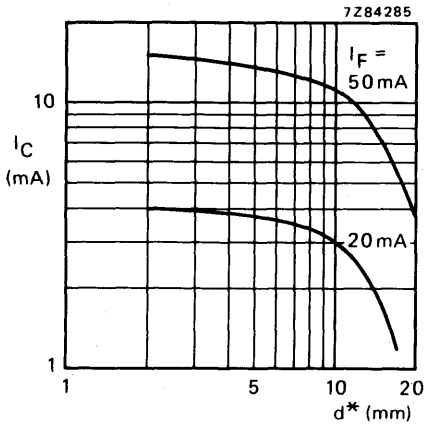

Fig. 8  $V_{CE} = 5\text{ V}$ ;  $T_{amb} = 25\text{ }^\circ\text{C}$ ; typical values.

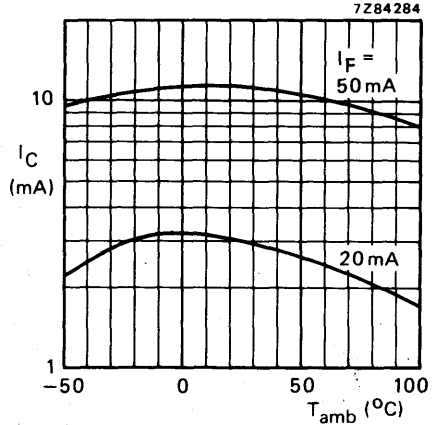

Fig. 9  $V_{CE} = 5\text{ V}$ ;  $d^* = 10\text{ mm}$ ; typical values.

\*  $d$  = shortest free distance of mechanical on-axis when BPW22A is coupled with CQY58A.



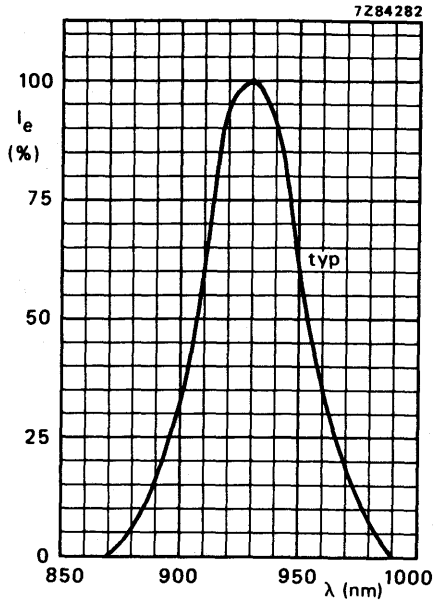

Fig. 10 Spectral response.

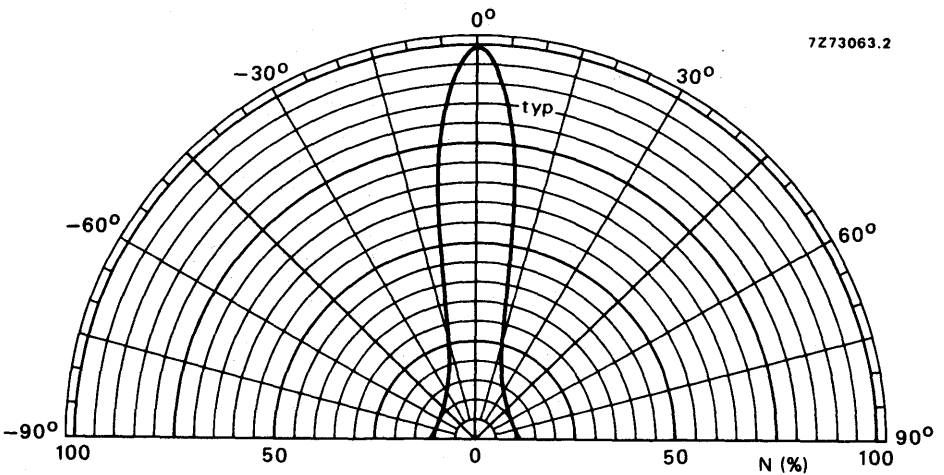

Fig. 11.



## GaAs LIGHT EMITTING DIODE

Epitaxial gallium arsenide light emitting diode intended for remote-control applications. It emits radiation in the near infrared when forward biased. Infrared translucent epoxy encapsulation (dark blue).

## QUICK REFERENCE DATA

Continuous reverse voltage	$V_R$	max.	5	V
Forward current (d.c.)	$I_F$	max.	130	mA
Total power dissipation up to $T_{amb} = 25\text{ }^\circ\text{C}$	$P_{tot}$	max.	215	mW
Junction temperature	$T_j$	max.	100	$^\circ\text{C}$
Radiant intensity (on-axis) at $I_F = 100\text{ mA}$	$I_e$	>	9	mW/sr
Wavelength at peak emission	$\lambda_{pk}$	typ.	930	nm

This data must be read in conjunction with GENERAL SAFETY RECOMMENDATIONS – OPTOELECTRONIC DEVICES

## PRODUCT SAFETY

Modern high technology materials have been used in the manufacture of this device to ensure high performance. Some of these materials are toxic in certain circumstances. Mechanical or electrical damage is unlikely to give rise to any hazard, but toxic vapours may be generated if the device is heated to destruction. Disposal of large quantities should therefore be carried out in accordance with the Deposit of Poisonous Waste Act 1972 and the Control of Pollution Act 1974, or with the latest legislation.

## MECHANICAL DATA

Dimensions in mm

Fig.1 SOD-63 (T-1%)

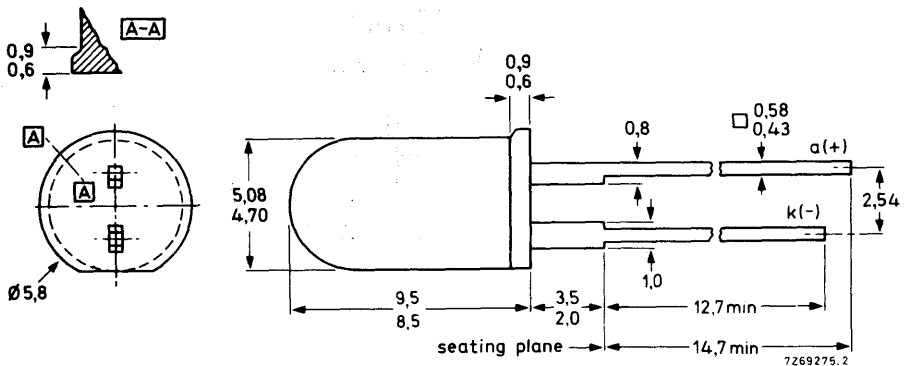

**ACCESSORIES**

For panel mounting (panel thickness < 4 mm)

Plastic clip and ring, black: type RTC757A

Hole diameter 6.4 mm for panel thickness < 3 mm

6.5 mm for panel thickness > 3 mm

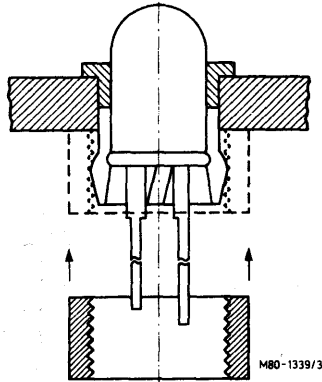
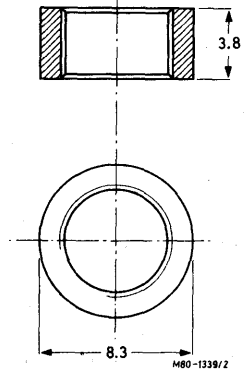
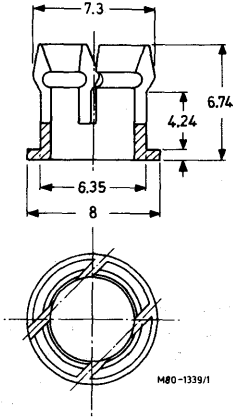

**RATINGS**

Limiting values in accordance with the Absolute Maximum System (IEC 134)

Continuous reverse voltage	$V_R$	max.	5	V
Forward current (d.c.)	$I_F$	max.	130	mA
Forward current (peak value)				
$t_p \leq 50 \mu\text{s}; \delta = 0.05$	$I_{FM}$	max.	1000	mA
Non-repetitive peak forward current ( $t_p \leq 10 \mu\text{s}$ )	$I_{FSM}$	max.	2500	mA
Total power dissipation up to $T_{amb} = 25^\circ\text{C}$	$P_{tot}$	max.	215	mW
Storage temperature	$T_{stg}$		-55 to +100	$^\circ\text{C}$
Junction temperature	$T_j$	max.	100	$^\circ\text{C}$
Lead soldering temperature				
up to the seating plane; $t_{sld} < 10 \text{ s}$	$T_{sld}$	max.	260	$^\circ\text{C}$

**THERMAL RESISTANCE**

From junction to ambient

mounted on a printed board

$R_{th\ j-a}$	=	0.35	$^\circ\text{C}/\text{mW}$
---------------	---	------	----------------------------

**CHARACTERISTICS** $T_j = 25^\circ\text{C}$  unless otherwise specified

Forward voltage				
$I_F = 100 \text{ mA}$	$V_F$	typ.	1.4	V
		<	1.6	V
$I_{FM} = 1500 \text{ mA}$	$V_{FM}$	typ.	2.4	V
Reverse current				
$V_R = 5 \text{ V}$	$I_R$	<	100	$\mu\text{A}$
Diode capacitance				
$V_R = 0; f = 1 \text{ MHz}$	$C_d$	typ.	40	pF
Total radiant power				
$I_F = 100 \text{ mA}$	$\phi_e$	>	7	mW
		typ.	12	mW
Decrease of radiant power with temperature	$\frac{\Delta\phi_e}{\Delta T_j}$			
$I_F = 100 \text{ mA}$		typ.	1	%/ $^\circ\text{C}$
Radiant intensity (on-axis)				
$I_F = 100 \text{ mA}$	$I_e$	>	9	mW/sr
		typ.	15	mW/sr
Wavelength at peak emission				
$I_F = 100 \text{ mA}$	$\lambda_{pk}$	typ.	930	nm



# CQY89A

Bandwidth at half height

$I_F = 100 \text{ mA}$

$B_{50\%}$  typ. 50 nm

Beamwidth between half-intensity directions

$I_F = 100 \text{ mA}$

$\alpha_{50\%}$  typ. 40 degrees

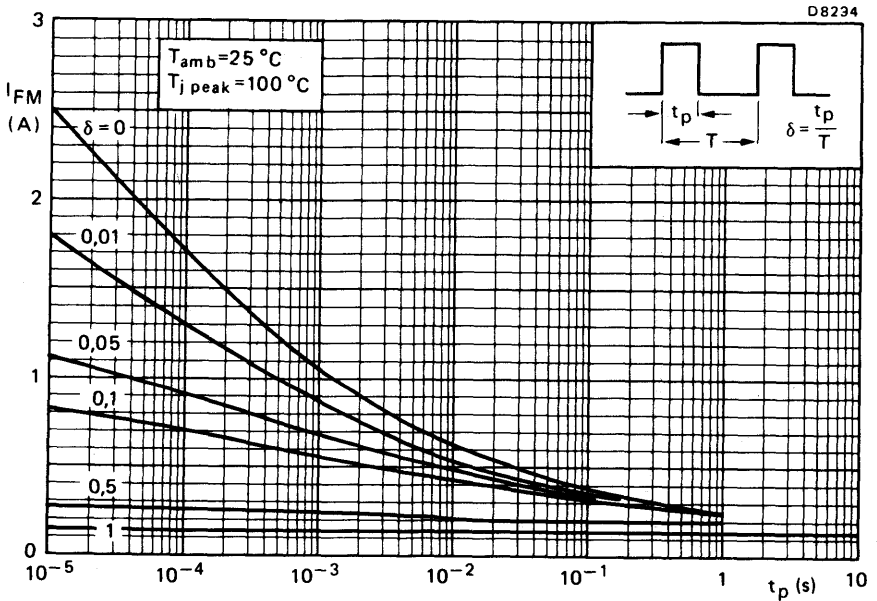

Fig.1





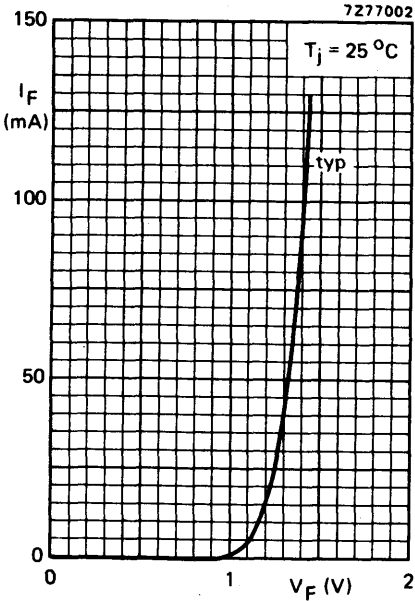

Fig.2

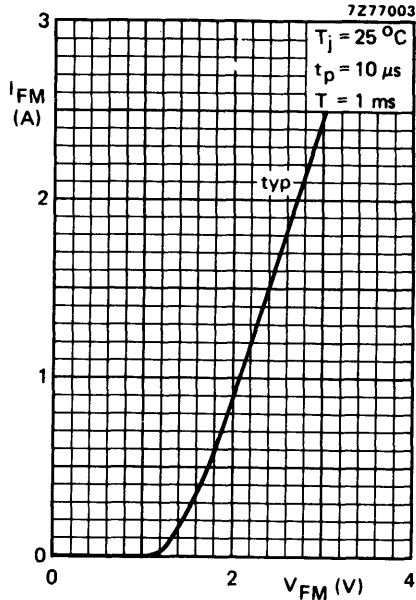

Fig.3

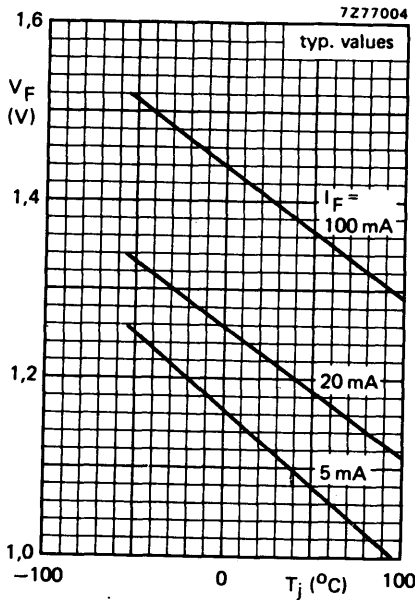

Fig.4



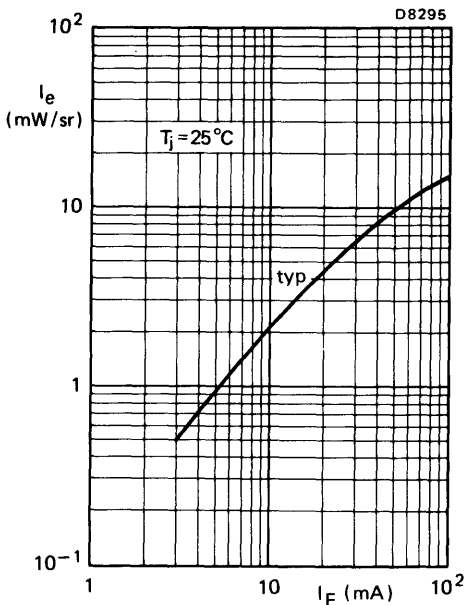

Fig.5

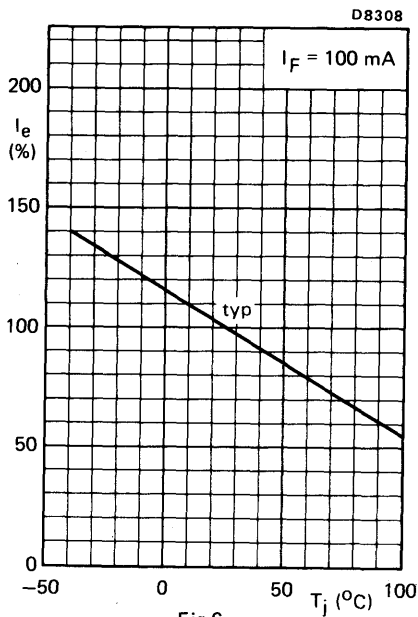

Fig.6

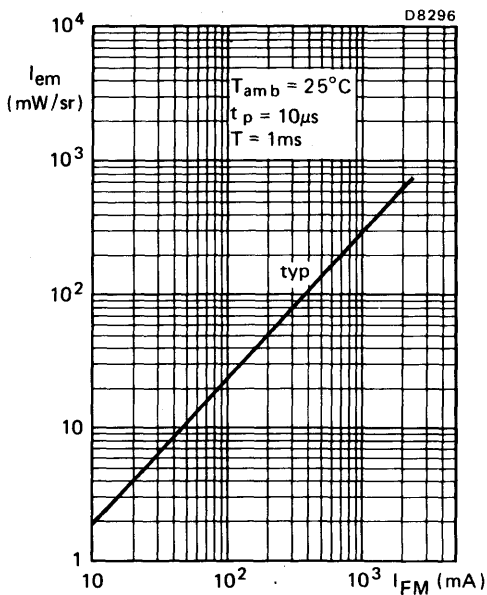

Fig.7



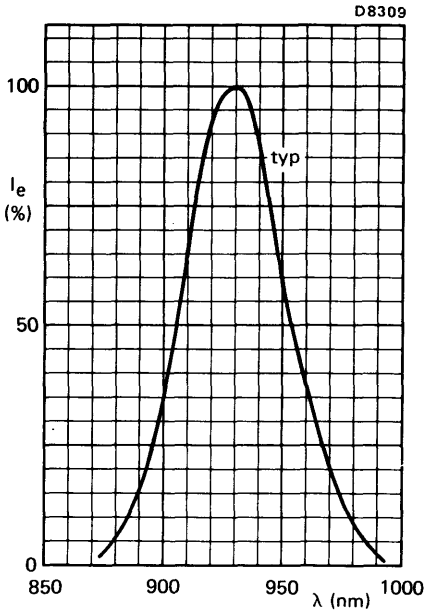

Fig.8

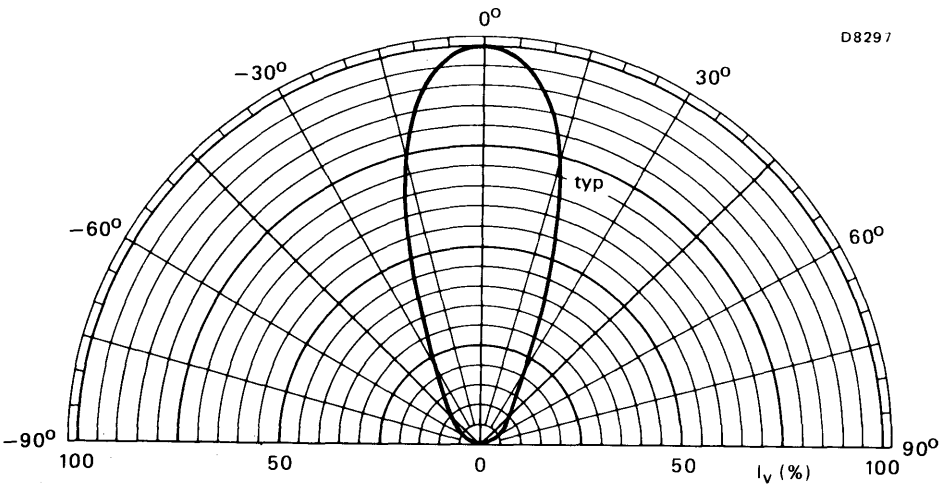

Fig.9





## GaP GREEN LIGHT EMITTING DIODE

Gallium phosphide light emitting diode which emits green light when forward biased. Green, light-diffusing plastic envelope.

## QUICK REFERENCE DATA

Continuous reverse voltage	$V_R$	max.	3	V
Forward current (d.c.)	$I_F$	max.	20	mA
Total power dissipation up to $T_{amb} = 55\text{ }^\circ\text{C}$	$P_{tot}$	max.	60	mW
Luminous intensity (on-axis) at $I_F = 10\text{ mA}$	$I_v$	min.	0.7	mcd
		typ.	1.0	mcd
Wavelength at peak emission	$\lambda_{pk}$	typ.	560	nm
Beamwidth between half-intensity directions	$\alpha_{50\%}$	typ.	$60^\circ$	

This data must be read in conjunction with GENERAL SAFETY RECOMMENDATIONS – OPTOELECTRONIC DEVICES

## PRODUCT SAFETY

Modern high technology materials have been used in the manufacture of this device to ensure high performance. Some of these materials are toxic in certain circumstances. Mechanical or electrical damage is unlikely to give rise to any hazard, but toxic vapours may be generated if the device is heated to destruction. Disposal of large quantities should therefore be carried out in accordance with the Deposit of Poisonous Waste Act 1972 and the Control of Pollution Act 1974, or with the latest legislation.

## MECHANICAL DATA

Dimensions in mm

Fig.1 SOD-63 (T-1½)

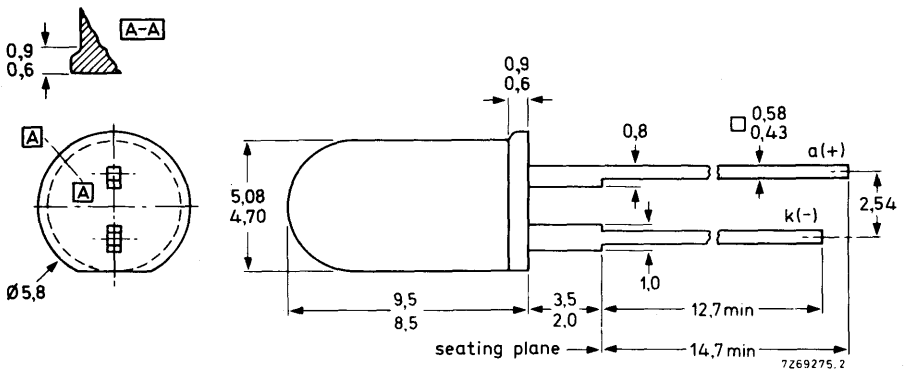

**ACCESSORIES**

For panel mounting (panel thickness < 4 mm)

Plastic clip and ring, black: type RTC757A

Hole diameter 6.4 mm for panel thickness < 3 mm  
6.5 mm for panel thickness > 3 mm

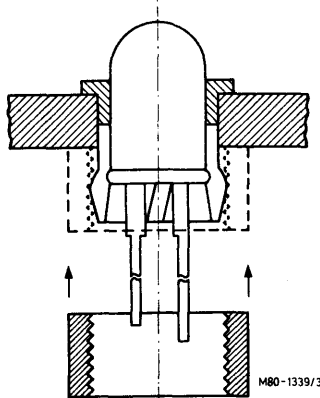
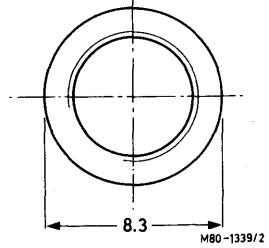
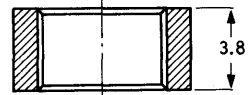
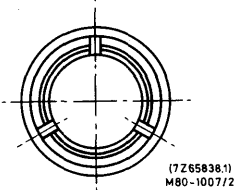
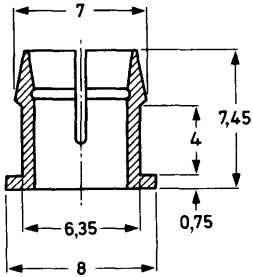

**RATINGS**

Limiting values in accordance with the Absolute Maximum System (IEC 134)

Continuous reverse voltage	$V_R$	max.	3	V
Forward current (d.c.)	$I_F$	max.	20	mA
Forward current (peak value)				
$t_p < 1$ ms; $f < 300$ Hz	$I_{FM}$	max.	60	mA
$t_p < 1$ $\mu$ s; $f < 300$ Hz	$I_{FM}$	max.	1000	mA
Total power dissipation up to $T_{amb} = 55$ °C	$P_{tot}$	max.	60	mW
Storage temperature	$T_{stg}$	max.	100	°C
Junction temperature	$T_j$		-55 to +100	°C
Lead soldering temperature > 1.5 mm from the seating plane; $t_{sld} < 7$ s	$T_{sld}$	max.	230	°C

**THERMAL RESISTANCE**

From junction to ambient in free air	$R_{th\ j-a}$	=	0.75	°C/mW
mounted on a printed-circuit board	$R_{th\ j-a}$	=	0.5	°C/mW

**CHARACTERISTICS** $T_j = 25$  °C unless otherwise specified

Forward voltage $I_F = 10$ mA	$V_F$	typ. <	2.1 3	V V
Reverse current $V_R = 3$ V	$I_R$	<	100	$\mu$ A
Diode capacitance $V_R = 0$ ; $f = 1$ MHz	$C_d$	typ.	35	pF
Luminous intensity (on axis)* $I_F = 10$ mA				
	CQY94-I	$I_v$	0.7 to 1.6	mcd
	CQY94-II	$I_v$	1.0 to 2.2	mcd
	CQY94-III	$I_v$	1.6 to 3.5	mcd
	CQY94-IV	$I_v$	> 3.0	mcd
Wavelength at peak emission	$\lambda_{pk}$	typ.	560	nm
Bandwidth at half height	$B_{50\%}$	typ.	30	nm
Beamwidth between half-intensity directions	$\alpha_{50\%}$	typ.	60°	

\*For applications using a number of devices in close proximity, thus requiring spreads of luminous intensity of less than 2.5 times, production is graded into groups indicated by suffixes. Specific groupings, subject to availability, may be obtained only by negotiation with the supplier.



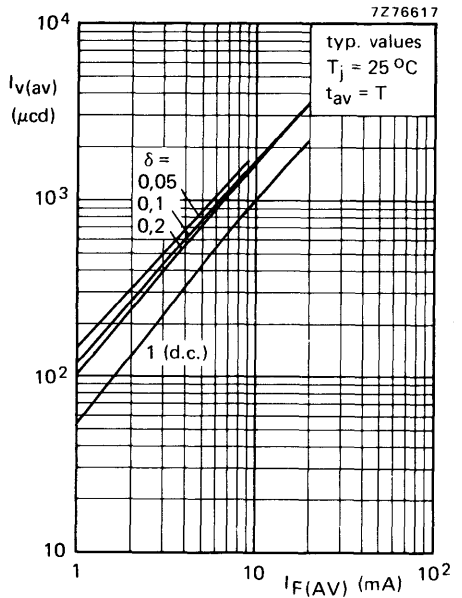
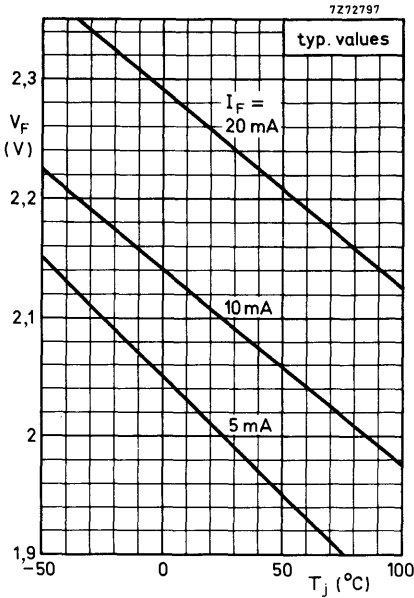
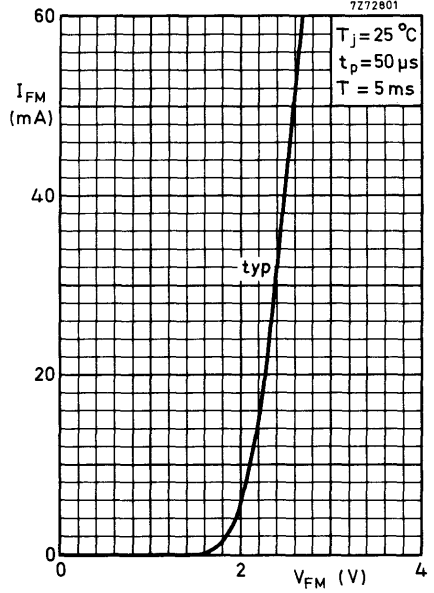
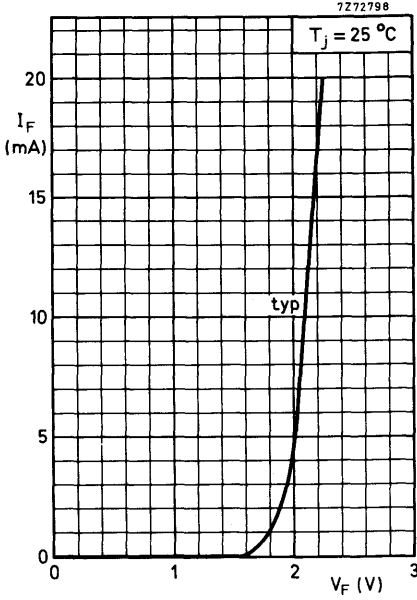



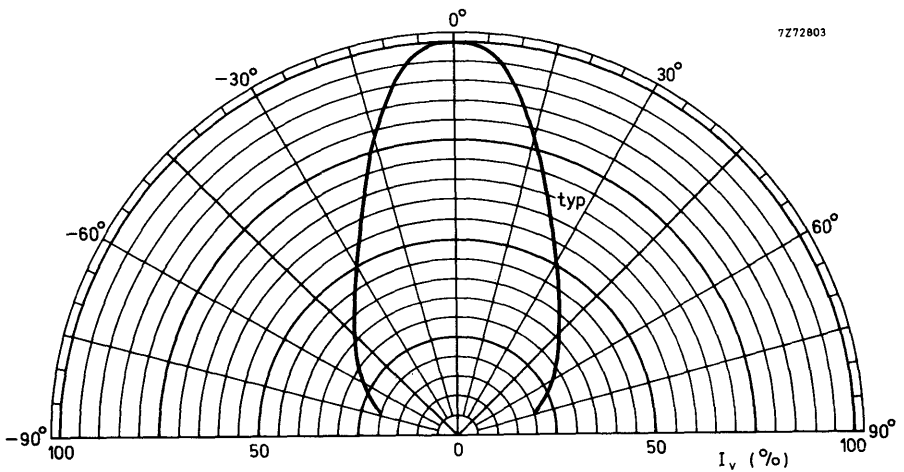
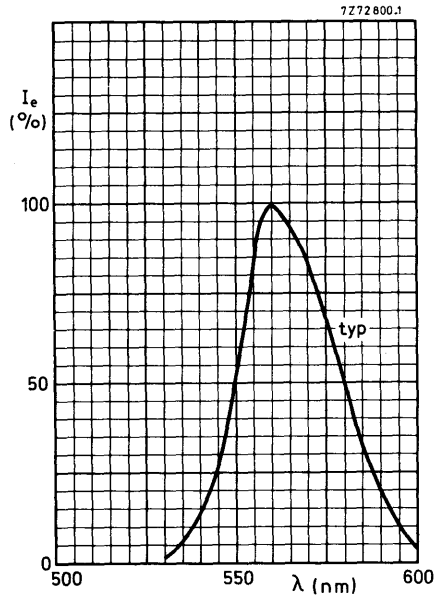
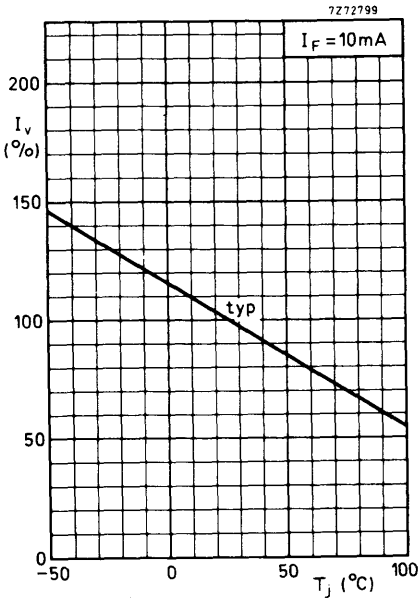



## GaP GREEN LIGHT EMITTING DIODE

Gallium phosphide light emitting diode which emits green light when forward biased. Green, light-diffusing plastic envelope.

### QUICK REFERENCE DATA

Continuous reverse voltage	$V_R$	max.	3 V
Forward current (d.c.)	$I_F$	max.	20 mA
Total power dissipation up to $T_{amb} = 55^\circ\text{C}$	$P_{tot}$	max.	60 mW
Luminous intensity (on-axis) at $I_F = 10\text{ mA}$	$I_v$	min.	0,3 mcd
		typ.	1,0 mcd
Wavelength at peak emission	$\lambda_{pk}$	typ.	560 nm
Beamwidth between half-intensity directions	$\alpha_{50\%}$	typ.	60°

This data must be read in conjunction with GENERAL SAFETY RECOMMENDATIONS – OPTOELECTRONIC DEVICES

### PRODUCT SAFETY

Modern high technology materials have been used in the manufacture of this device to ensure high performance. Some of these materials are toxic in certain circumstances. Mechanical or electrical damage is unlikely to give rise to any hazard, but toxic vapours may be generated if the device is heated to destruction. Disposal of large quantities should therefore be carried out in accordance with the Deposit of Poisonous Waste Act 1972 and the Control of Pollution Act 1974, or with the latest legislation.

### MECHANICAL DATA

Dimensions in mm

Fig.1 SOD-53C (T-1)

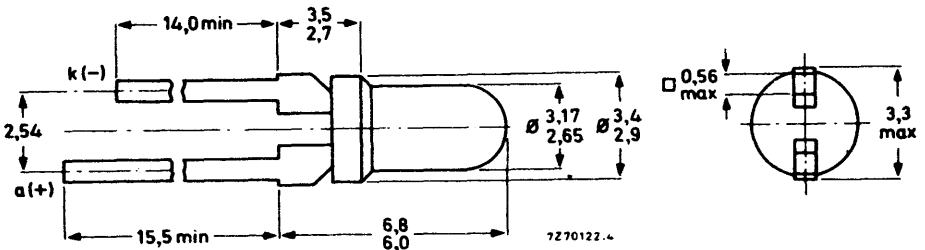

**RATINGS**

Limiting values in accordance with the Absolute Maximum System (IEC 134)

Continuous reverse voltage	$V_R$	max.	3 V
Forward current (d.c.)	$I_F$	max.	20 mA
Forward current (peak value)			
$t_p < 1$ ms; $f < 300$ Hz	$I_{FM}$	max.	60 mA
$t_p < 1$ $\mu$ s; $f < 300$ Hz	$I_{FM}$	max.	1000 mA
Total power dissipation up to $T_{amb} = 55$ °C	$P_{tot}$	max.	60 mW
Storage temperature	$T_{stg}$		-55 to + 100 °C
Junction temperature	$T_j$	max.	100 °C
Lead soldering temperature			
> 3 mm from the seating plane; $t_{sld} < 7$ s	$T_{sld}$	max.	230 °C

**THERMAL RESISTANCE**

From junction to ambient in free air	$R_{th j-a}$	=	0,75 °C/mW
mounted on a printed-circuit board	$R_{th j-a}$	=	0,5 °C/mW

**CHARACTERISTICS**

$T_j = 25$  °C unless otherwise specified

Forward voltage			
$I_F = 10$ mA	$V_F$	typ. <	2,1 V 3 V
Reverse current			
$V_R = 3$ V	$I_R$	<	100 $\mu$ A
Diode capacitance			
$V_R = 0$ ; $f = 1$ MHz	$C_d$	typ.	35 pF
Luminous intensity (on-axis)*			
$I_F = 10$ mA	CQY95	$I_v$	> 0,3 mcd
	CQY95-I	$I_v$	0,7 to 1,6 mcd
	CQY95-II	$I_v$	1,0 to 2,2 mcd
	CQY95-III	$I_v$	> 1,6 mcd
Wavelength at peak emission	$\lambda_{pk}$	typ.	560 nm
Bandwidth at half height	B50%	typ.	30 nm
Beamwidth between half-intensity directions	$\alpha_{50\%}$	typ.	60°

\* For applications using a number of devices in close proximity, thus requiring spreads of luminous intensity of less than 2.5 times, production is graded into groups indicated by suffixes. Specific groupings, subject to availability, may be obtained only by negotiation with the supplier.



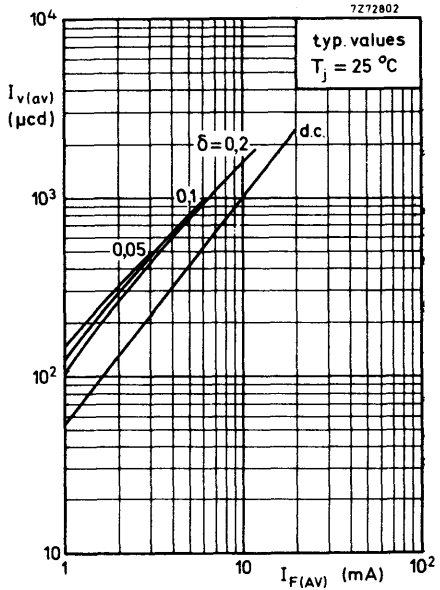
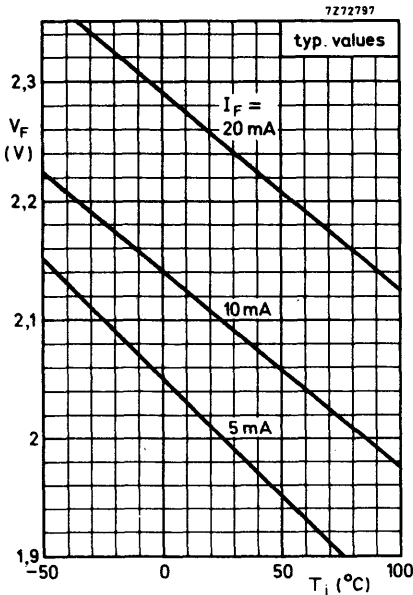
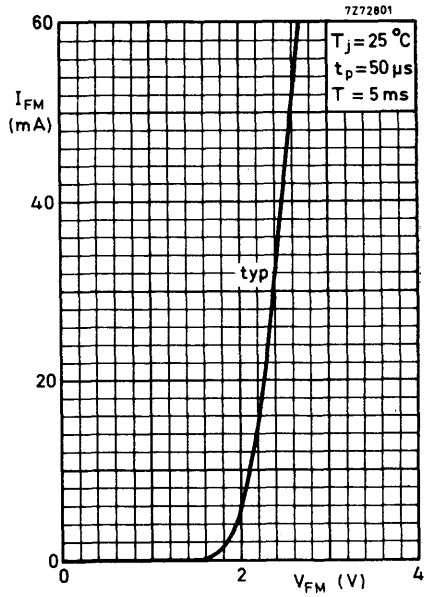
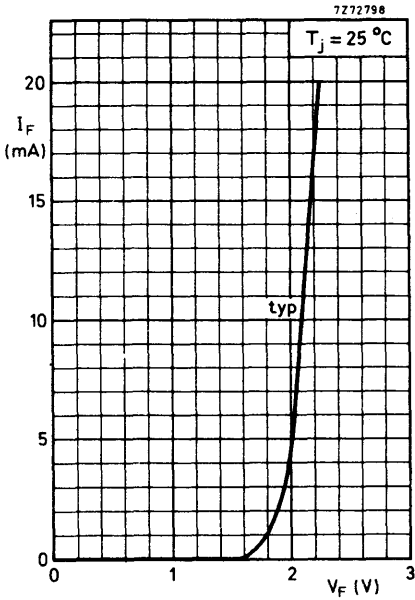

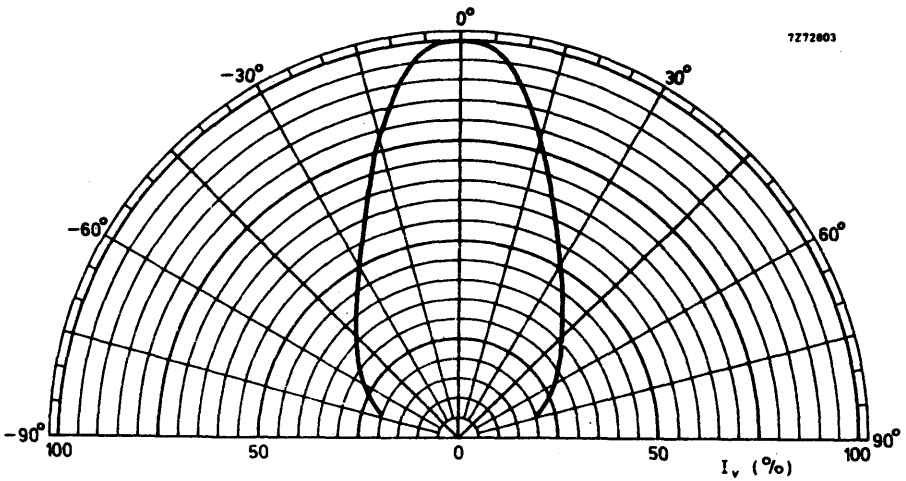
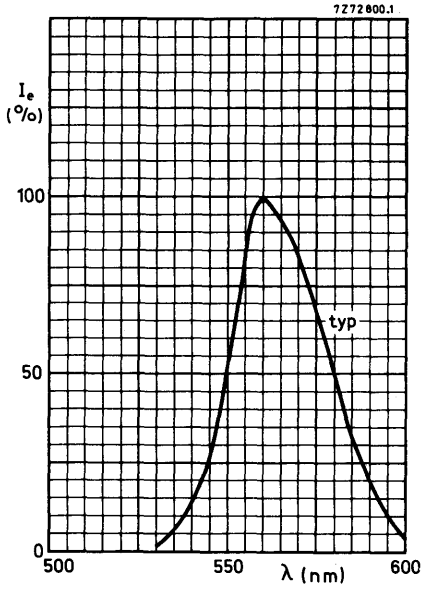
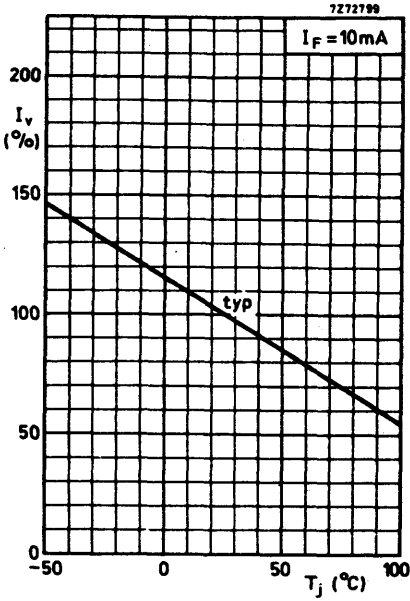

## GaAsp YELLOW LIGHT EMITTING DIODE

Gallium arsenide phosphide light emitting diode which emits yellow light when forward biased.  
Yellow, light-diffusing plastic envelope.

### QUICK REFERENCE DATA

Continuous reverse voltage	$V_R$	max.	3	V
Forward current (d.c.)	$I_F$	max.	20	mA
Total power dissipation up to $T_{amb} = 55\text{ }^\circ\text{C}$	$P_{tot}$	max.	60	mW
Luminous intensity (on-axis) at $I_F = 10\text{ mA}$	$I_v$	min. typ.	0.7 1.0	mcd mcd
Wavelength at peak emission	$\lambda_{pk}$	typ.	590	nm
Beamwidth between half-intensity directions	$\alpha_{50\%}$	typ.	$60^\circ$	

This data must be read in conjunction with GENERAL SAFETY RECOMMENDATIONS – OPTOELECTRONIC DEVICES

### PRODUCT SAFETY

Modern high technology materials have been used in the manufacture of this device to ensure high performance. Some of these materials are toxic in certain circumstances. Mechanical or electrical damage is unlikely to give rise to any hazard, but toxic vapours may be generated if the device is heated to destruction. Disposal of large quantities should therefore be carried out in accordance with the Deposit of Poisonous Waste Act 1972 and the Control of Pollution Act 1974, or with the latest legislation.

### MECHANICAL DATA

Dimensions in mm

Fig.1 SOD-63 (T-1%)

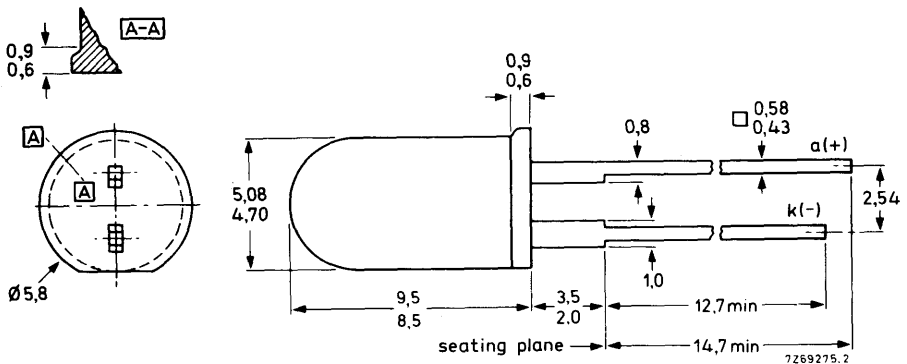

**ACCESSORIES**

For panel mounting (panel thickness < 4 mm)

Plastic clip and ring, black: type RTC757A

Hole diameter 6.4 mm for panel thickness < 3 mm

6.5 mm for panel thickness > 3 mm

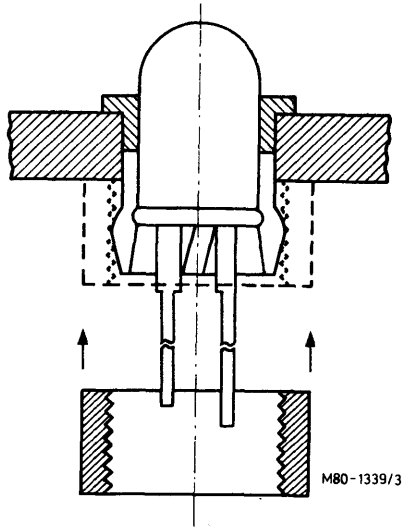
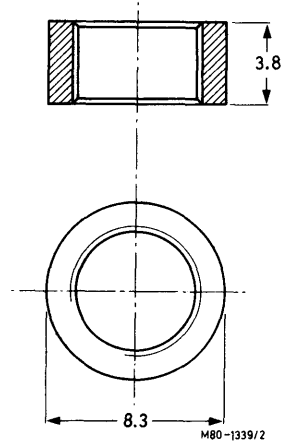
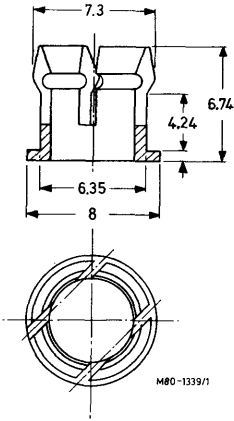



**RATINGS**

Limiting values in accordance with the Absolute Maximum System (IEC 134)

Continuous reverse voltage	$V_R$	max.	3 V
Forward current (d.c.)	$I_F$	max.	20 mA
Forward current (peak value)			
$t_p < 1$ ms; $f < 300$ Hz	$I_{FM}$	max.	60 mA
$t_p < 1$ $\mu$ s; $f < 300$ Hz	$I_{FM}$	max.	1000 mA
Total power dissipation up to $T_{amb} = 55$ °C	$P_{tot}$	max.	60 mW
Storage temperature	$T_{stg}$		-55 to +100 °C
Junction temperature	$T_j$	max.	100 °C
Lead soldering temperature			
> 1.5 mm from the seating plane; $t_{sld} < 7$ s	$T_{sld}$	max.	230 °C

**THERMAL RESISTANCE**

From junction to ambient			
in free air	$R_{th\ j-a}$	=	0.75 °C/mW
mounted on a printed board	$R_{th\ j-a}$	=	0.5 °C/mW

**CHARACTERISTICS** $T_j = 25$  °C unless otherwise specified

Forward voltage			
$I_F = 10$ mA	$V_F$	typ.	2.1 V
		<	3 V
Reverse current			
$V_R = 3$ V	$I_R$	<	100 $\mu$ A
Diode capacitance			
$V_R = 0$ ; $f = 1$ MHz	$C_d$	typ.	35 pF
Luminous intensity (on-axis)*			
$I_F = 10$ mA			
	CQY96-I	$I_v$	0.7 to 1.6 mcd
	CQY96-II	$I_v$	1.0 to 2.2 mcd
	CQY96-III	$I_v$	1.6 to 3.5 mcd
	CQY96-IV	$I_v$	> 3.0 mcd
Wavelength at peak emission	$\lambda_{pk}$	typ.	590 nm
Bandwidth at half height	$B_{50\%}$	typ.	38 nm
Beamwidth between half-intensity directions	$\alpha_{50\%}$	typ.	60°

\*For applications using a number of devices in close proximity, thus requiring spreads of luminous intensity of less than 2.5 times, production is graded into groups indicated by suffixes. Specific groupings, subject to availability, may be obtained only by negotiation with the supplier.



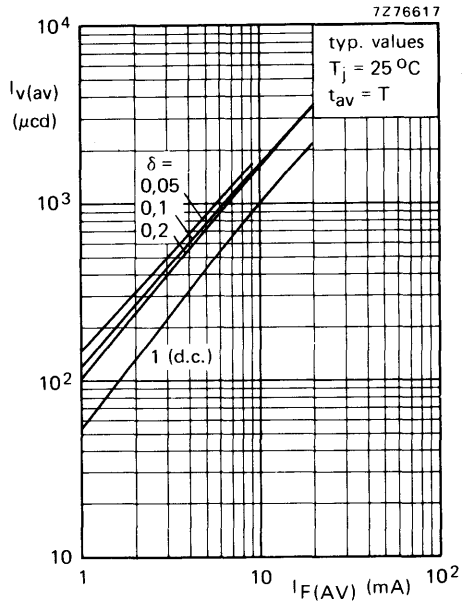
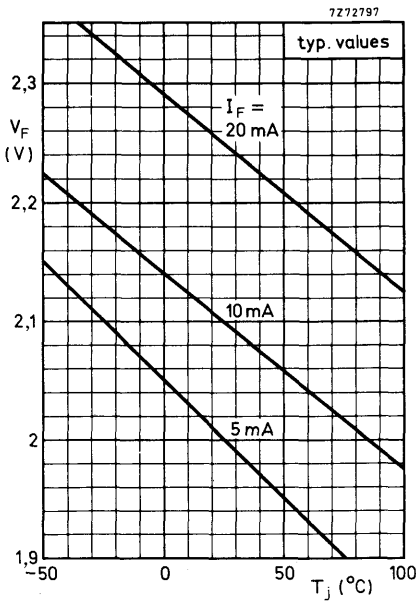
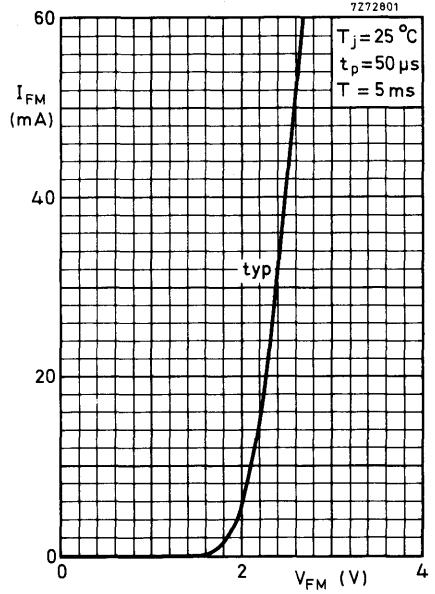
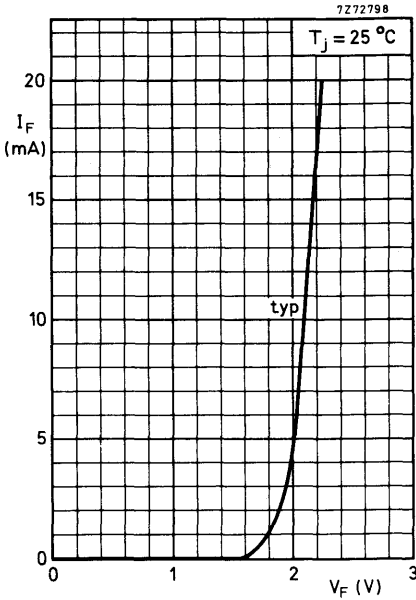

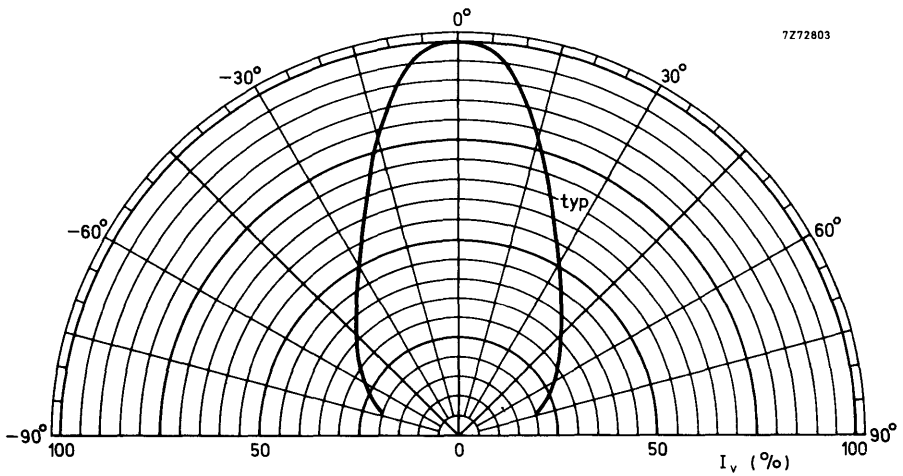
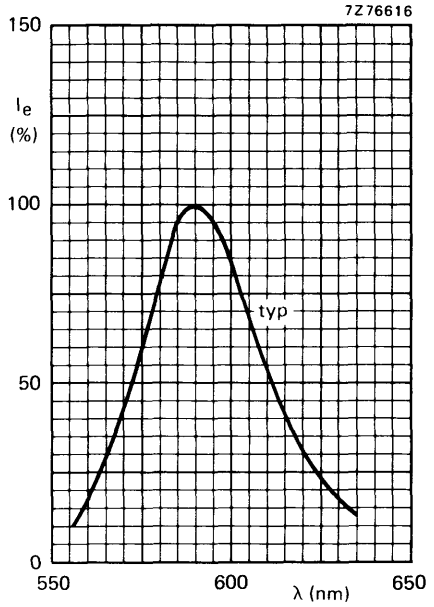
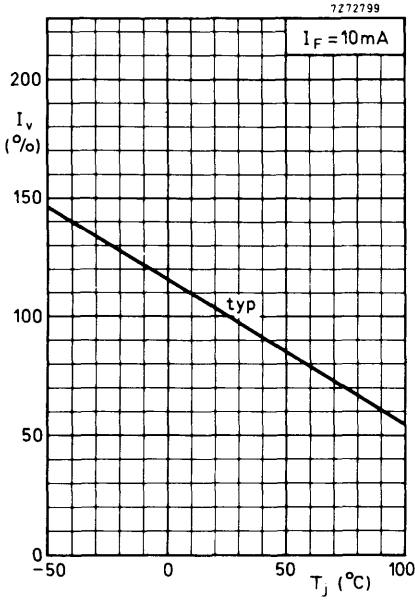



## GaAsP YELLOW LIGHT EMITTING DIODE

Gallium arsenide phosphide light emitting diode which emits yellow light when forward biased.  
Yellow, light-diffusing plastic envelope.

### QUICK REFERENCE DATA

Continuous reverse voltage	$V_R$	max.	3 V
Forward current (d.c.)	$I_F$	max.	20 mA
Total power dissipation up to $T_{amb} = 55\text{ }^\circ\text{C}$	$P_{tot}$	max.	60 mW
Luminous intensity (on-axis) at $I_F = 10\text{ mA}$	$I_v$	min.	0,3 mcd
	$I_v$	typ.	1.0 mcd
Wavelength at peak emission	$\lambda_{pk}$	typ.	590 nm
Beamwidth between half-intensity directions	$\alpha_{50\%}$	typ.	$60^\circ$

This data must be read in conjunction with GENERAL SAFETY RECOMMENDATIONS – OPTOELECTRONIC DEVICES

### PRODUCT SAFETY

Modern high technology materials have been used in the manufacture of this device to ensure high performance. Some of these materials are toxic in certain circumstances. Mechanical or electrical damage is unlikely to give rise to any hazard, but toxic vapours may be generated if the device is heated to destruction. Disposal of large quantities should therefore be carried out in accordance with the Deposit of Poisonous Waste Act 1972 and the Control of Pollution Act 1974, or with the latest legislation.

### MECHANICAL DATA

Dimensions in mm

Fig.1 SOD-53C (T-1)

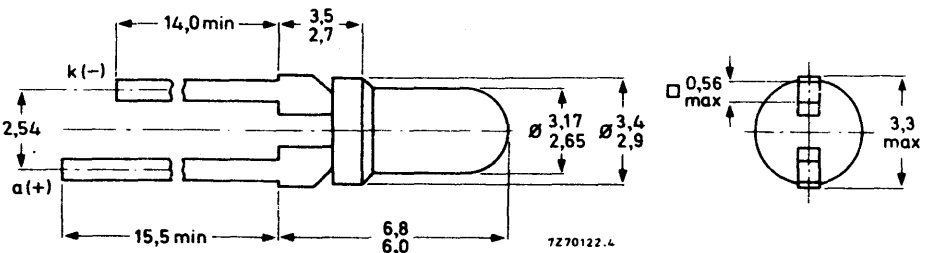

**RATINGS**

Limiting values in accordance with the Absolute Maximum System (IEC 134)

Continuous reverse voltage	$V_R$	max.	3 V
Forward current (d.c.)	$I_F$	max.	20 mA
Forward current (peak value)			
$t_p < 1$ ms; $f < 300$ Hz	$I_{FM}$	max.	60 mA
$t_p < 1$ $\mu$ s; $f < 300$ Hz	$I_{FM}$	max.	1000 mA
Total power dissipation up to $T_{amb} = 55$ °C	$P_{tot}$	max.	60 mW
Storage temperature	$T_{stg}$		-55 to + 100 °C
Junction temperature	$T_j$	max.	100 °C
Lead soldering temperature			
> 3 mm from the seating plane; $t_{sld} < 7$ s	$T_{sld}$	max.	230 °C

**THERMAL RESISTANCE**

From junction to ambient			
in free air	$R_{th\ j-a}$	=	0,75 °C/mW
mounted on a printed board	$R_{th\ j-a}$	=	0,5 °C/mW

**CHARACTERISTICS**

$T_j = 25$  °C unless otherwise specified

Forward voltage			
$I_F = 10$ mA	$V_F$	typ.	2,1 V
		<	3 V
Reverse current			
$V_R = 3$ V	$I_R$	<	100 $\mu$ A
Diode capacitance			
$V_R = 0$ ; $f = 1$ MHz	$C_d$	typ.	35 pF
Luminous intensity (on-axis)*			
$I_F = 10$ mA	CQY97	$I_v$	> 0,3 mcd
	CQY97-I	$I_v$	0,7 to 1,6 mcd
	CQY97-II	$I_v$	1,0 to 2,2 mcd
	CQY97-III	$I_v$	> 1,6 mcd
Wavelength at peak emission	$\lambda_{pk}$	typ.	590 nm
Bandwidth at half height	$B_{50\%}$	typ.	38 nm
Beamwidth between half-intensity directions	$\alpha_{50\%}$	typ.	60°

\* For applications using a number of devices in close proximity, thus requiring spreads of luminous intensity of less than 2.5 times, production is graded into groups indicated by suffixes. Specific groupings, subject to availability, may be obtained only by negotiation with the supplier.



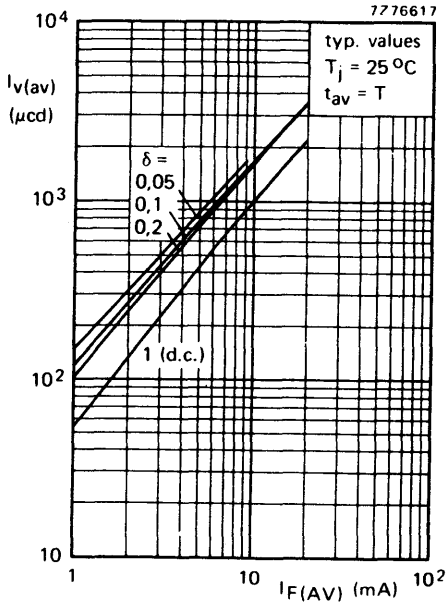
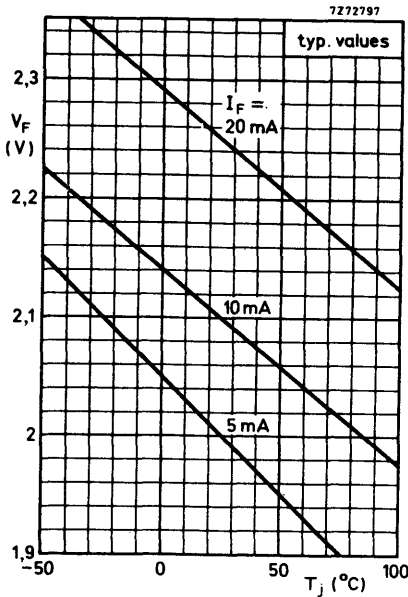
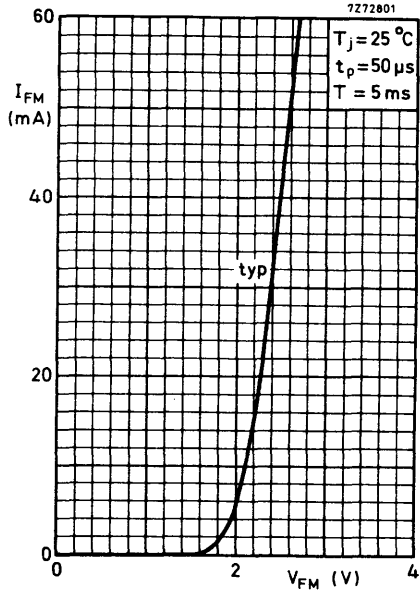
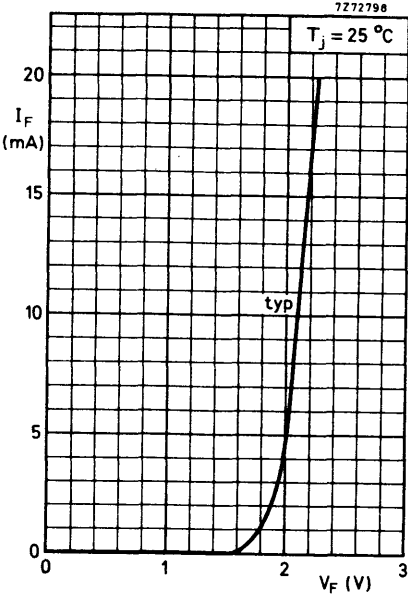

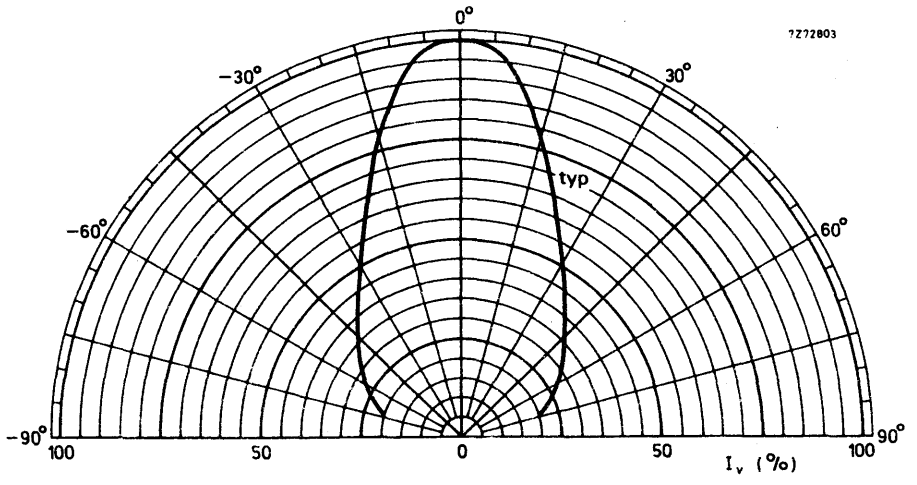
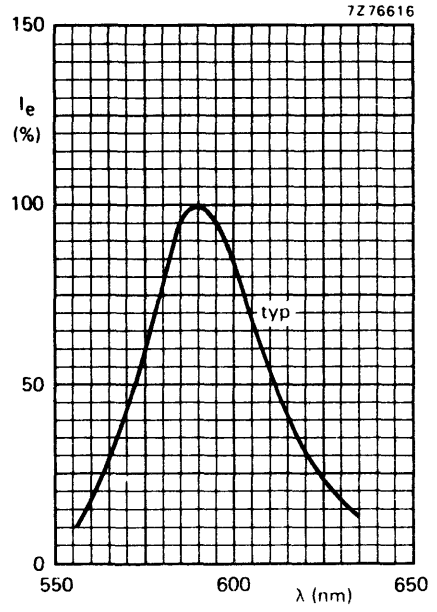
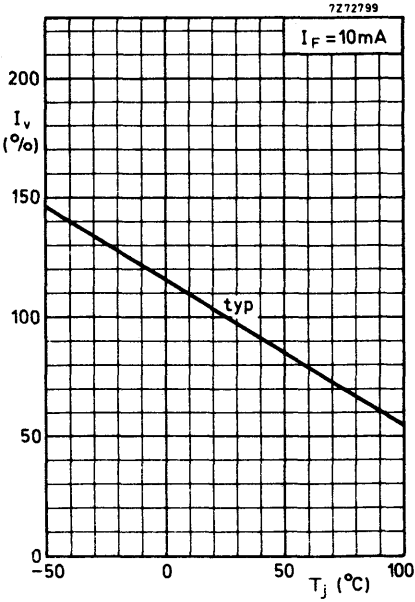



# INFRARED DETECTORS

ORP13  
RPY31  
RPY35  
RPY51  
RPY52  
RPY86,7  
RPY88,9  
RPY90 series  
RPY91 series  
RPY93  
RPY96  
61SV

D



≡ D

## INFRARED DETECTOR

Indium antimonide photoconductive element mounted in a glass dewar and cooled by liquid nitrogen. It is sensitive to infrared radiation extending to 5.6  $\mu\text{m}$  and is intended for use with modulated or pulsed radiation.

### QUICK REFERENCE DATA

Wavelength at peak response	$\lambda_{pk}$	5.3	$\mu\text{m}$
Operating temperature	T	77	K
D* (500 K, 800, 1)		min. $5.0 \times 10^9$	$\text{cmHz}^{1/2}\text{W}^{-1}$
Time constant	typ.	5	$\mu\text{s}$
Sensitive area		$6.0 \times 0.5$	$\text{mm}$

This data must be read in conjunction with GENERAL SAFETY RECOMMENDATIONS – OPTOELECTRONIC DEVICES

### PRODUCT SAFETY

Modern high technology materials have been used in the manufacture of this device to ensure high performance. Some of these materials are toxic in certain circumstances. Mechanical or electrical damage is unlikely to give rise to any hazard, but toxic vapours may be generated if the device is heated to destruction. Disposal of large quantities should therefore be carried out in accordance with the Deposit of Poisonous Waste Act 1972 and the Control of Pollution Act 1974, or with the latest legislation.

### MECHANICAL DATA

Dimensions in mm

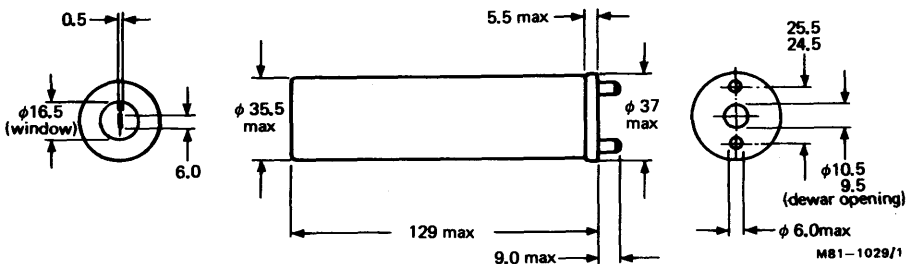

**RATINGS**

Limiting values in accordance with the Absolute Maximum System (IEC134)

Bias current at 77 K	I	max.	10	mA
Storage temperature range	T <sub>stg</sub>		-55 to +55	°C
Operating temperature			77	K

**CHARACTERISTICS** (cooled to 77 K under conditions specified in note 1)

Wavelength at peak response	λ <sub>pk</sub>		5.3	μm
Spectral response range			visible to 5.6	μm
Cell resistance range			20 to 60	kΩ
Time constant, note 2		typ.	5	μs
Boil off time of bulk liquid nitrogen		min.	90	minutes
		typ.	120	minutes

**BLACK BODY PERFORMANCE, 500 K, note 1**

Responsivity (500 K, 800)	min.	4 x 10 <sup>3</sup>	VW <sup>-1</sup>
	typ.	7 x 10 <sup>3</sup>	VW <sup>-1</sup>
D* (500 K, 800, 1)	min.	5 x 10 <sup>9</sup>	cmHz <sup>1/2</sup> W <sup>-1</sup>
	typ.	1.0 x 10 <sup>10</sup>	cmHz <sup>1/2</sup> W <sup>-1</sup>
N.E.P. (500 K, 800, 1)	typ.	2.3 x 10 <sup>-11</sup>	WHz <sup>-1/2</sup>
	max.	3.5 x 10 <sup>-11</sup>	WHz <sup>-1/2</sup>

**MONOCHROMATIC PERFORMANCE, note 1**

Responsivity (5.3 μm, 800)	typ.	3.5 x 10 <sup>4</sup>	VW <sup>-1</sup>
D* (5.3 μm, 800, 1)	typ.	5.5 x 10 <sup>10</sup>	cmHz <sup>1/2</sup> W <sup>-1</sup>
N.E.P. (5.3 μm, 800, 1)	typ.	4.0 x 10 <sup>-12</sup>	WHz <sup>-1/2</sup>



## NOTES

## 1. Test conditions

The detector is cooled to 77 K by filling the dewar vessel with liquid nitrogen, or by use of a liquid transfer system. An optimum bias of 250 to 500  $\mu\text{A}$  is applied. The sensitive element is situated at a distance of 264 mm from a black body source limited by an aperture of 3 mm diameter.

The radiation path is interrupted at 800 Hz by a chopper blade at ambient temperature. Under these conditions the r.m.s. power at the element (chopping factor 2.2) is  $4.5 \mu\text{Wcm}^{-2}$ .

Measurements of the detector output are made with an amplifier tuned to 800 Hz with a bandwidth of 50 Hz, and referred to open-circuit conditions, i.e. correction is made for the shunting effects of the bias supply impedance and the amplifier impedance.

The figures in brackets which follow responsivity,  $D^*$  and N.E.P. refer to the test conditions, for example,  $D^*$  (5.3  $\mu\text{m}$ , 800, 1) denotes monochromatic radiation incident on the detector of wavelength 5.3  $\mu\text{m}$ , modulation frequency 800 Hz, an electronic bandwidth of Hz.

$D^*$  and N.E.P.

These are figures of merit for the materials of detectors and are fully discussed in most textbooks on infrared.

$D^*$  is defined in the expression:

$$D^* = \frac{\frac{V_s}{V_n} \times [A (\Delta f)]^{1/2}}{W}$$

where $V_s$	=	Signal voltage across detector terminals
$V_n$	=	Noise voltage across detector terminals
A	=	Detector area
( $\Delta f$ )	=	Bandwidth of measuring amplifier
W	=	Radiation power incident on detector sensitive element (r.m.s. value, in watts)

The Noise Equivalent Power (N.E.P.) is related to  $D^*$  by the expression:

$$\text{N.E.P.} = \frac{(A)^{1/2}}{D^*}$$

Variation of performance with bias current

Both signal and noise vary with bias current in this type of cell. Typical curves are shown on page 5. At high currents the noise increases more rapidly than the signal, and therefore the signal to noise ratio has a peak value at some optimum current, which will vary slightly from cell to cell.

## 2. Time constant

Detector time constant figures are based on the response to a step function in the incident radiation. Quoted times indicate the interval between the moment the radiation is cut off and the output falling to 63% of its peak value.

## 3. Warnings

a. The resistance of the cell at room temperature is three orders of magnitude less than at the operating temperature (77 K). Care should therefore be taken to ensure that the device is not allowed to reach room temperature while still biased. If any form of low impedance biasing is employed.



3. Warnings (continued)

- b. If provision is made for cells to be plugged into the bias current and amplifier, steps must be taken to limit the current available from the amplifier input capacitor. This current can be excessive at the instant of plugging in the cell.  
A zener diode can be used to limit the voltage developed across the input capacitor as shown in the diagram. The polarity of the supply to the cell is not important.

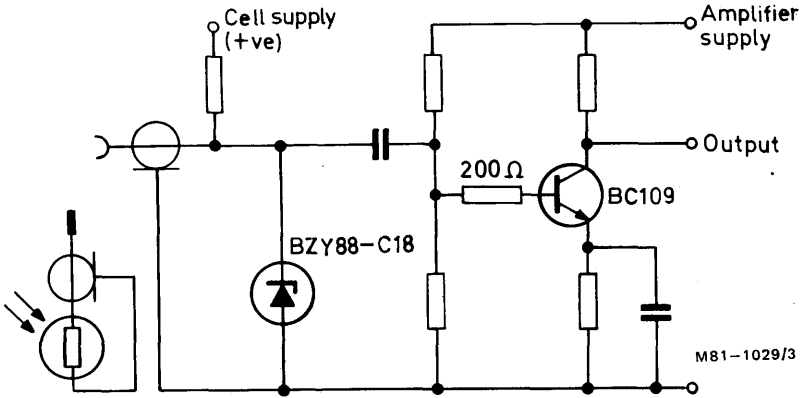

- c. The dewar vessel must always be completely dry before being refilled with liquid nitrogen. In humid conditions, water vapour may condense at the top of the dewar. Should this occur, the remaining liquid nitrogen should be allowed to boil off, the ice should be removed carefully and precautions taken to avoid a recurrence. In very humid conditions the window should be purged with a clean dry gas.

4. Low frequency noise

This will be minimised by use of non-absorbent cotton wool placed in the bottom of the dewar. The recommended quantity is 40 mg.



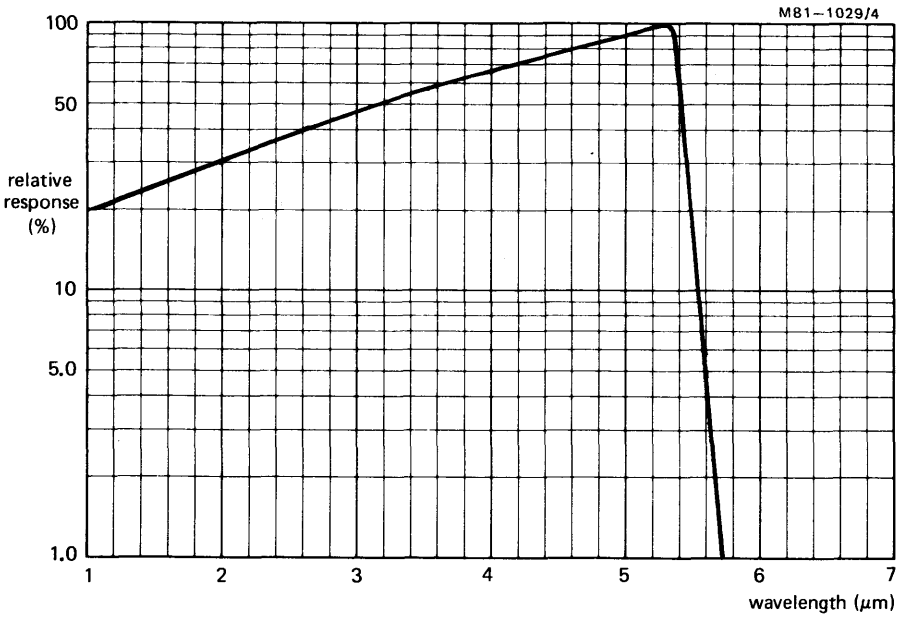

Typical spectral response



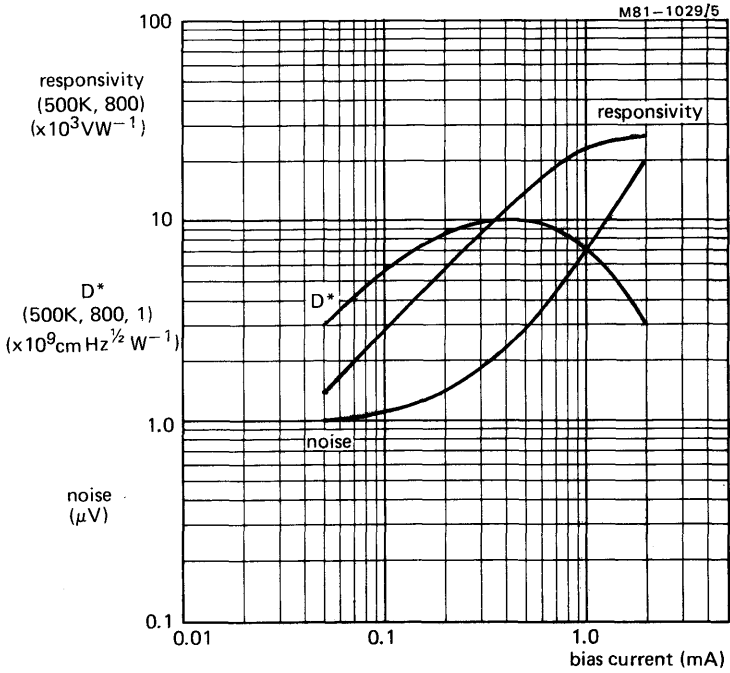

Typical responsivity, D\* and noise as functions of bias current





## INFRARED DETECTOR

Indium antimonide photoconductive element mounted in a glass dewar vessel and cooled by liquid nitrogen. It is sensitive to infrared radiation extending to 5.6  $\mu\text{m}$  and is intended for use with modulated or pulsed radiation.

### QUICK REFERENCE DATA

Wavelength at peak response	5.3	$\mu\text{m}$
Operating temperature	77	K
D* (500 K, 800, 1) min.	$7.2 \times 10^9$	$\text{cmHz}^{1/2}\text{W}^{-1}$
Time constant, typical	5	$\mu\text{s}$
Element dimensions	$4.0 \times 4.0$	mm

This data must be read in conjunction with GENERAL SAFETY RECOMMENDATIONS – OPTOELECTRONIC DEVICES

### PRODUCT SAFETY

Modern high technology materials have been used in the manufacture of this device to ensure high performance. Some of these materials are toxic in certain circumstances. Mechanical or electrical damage is unlikely to give rise to any hazard, but toxic vapours may be generated if the device is heated to destruction. Disposal of large quantities should therefore be carried out in accordance with the Deposit of Poisonous Waste Act 1972 and the Control of Pollution Act 1974, or with the latest legislation.

### MECHANICAL DATA

Dimensions in mm

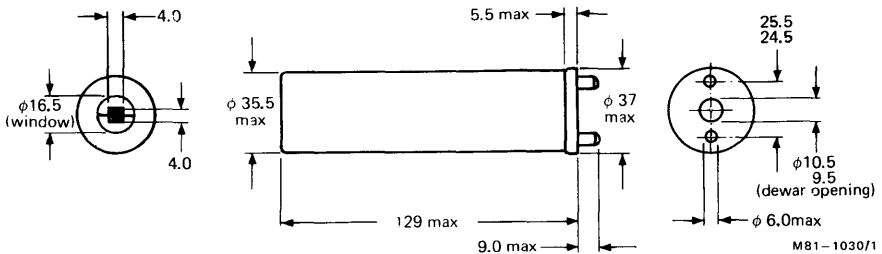

MIRROR ATTACHMENT - TYPE 13

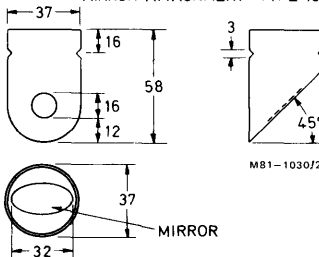

**RATINGS**

Limiting values in accordance with the Absolute Maximum System (IEC134)

Bias current at 77 K	I	max.	15	mA
Storage temperature range	T <sub>stg</sub>		-55 to +55	°C
Operating temperature			77	K

**CHARACTERISTICS** (cooled to 77 K under conditions specified in note 1)

Wavelength at peak response	$\lambda_{pk}$		5.3	$\mu\text{m}$
Spectral response range (see page 5)		visible to	5.6	$\mu\text{m}$
Cell resistance range			1.0 to 5.0	k $\Omega$
Time constant, note 2		typ.	5	$\mu\text{s}$
Boil off time of bulk liquid nitrogen		min.	90	minutes
		typ.	120	minutes

**BLACK BODY PERFORMANCE, 500 K, note 1**

Responsivity (500 K, 800)		min.	$0.5 \times 10^3$	VW <sup>-1</sup>
		typ.	$0.8 \times 10^3$	VW <sup>-1</sup>
D* (500 K, 800, 1)		min.	$7.2 \times 10^9$	cmHz <sup>1/2</sup> W <sup>-1</sup>
		typ.	$8.0 \times 10^9$	cmHz <sup>1/2</sup> W <sup>-1</sup>
N.E.P. (500 K, 800, 1)		typ.	$5.0 \times 10^{-11}$	WHz <sup>-1/2</sup>
		max.	$5.5 \times 10^{-11}$	WHz <sup>-1/2</sup>

**MONOCHROMATIC PERFORMANCE, note 1**

Responsivity (5.3 $\mu\text{m}$ , 800)		typ.	$3.8 \times 10^3$	VW <sup>-1</sup>
D* (5.3 $\mu\text{m}$ , 800, 1)		typ.	$4.0 \times 10^{10}$	cmHz <sup>1/2</sup> W <sup>-1</sup>
N.E.P. (5.3 $\mu\text{m}$ , 800, 1)		typ.	$1.0 \times 10^{-11}$	WHz <sup>-1/2</sup>



## NOTES

## 1. Test conditions

The detector is cooled to 77 K by filling the dewar vessel with liquid nitrogen, or by use of a liquid transfer system. An optimum bias of 3 mA is applied. The sensitive element is situated at a distance of 264 mm from a black body source limited by an aperture of 3 mm diameter.

The radiation path is interrupted at 800 Hz by a chopper blade at ambient temperature. Under these conditions the r.m.s. power at the element (chopping factor 2.2) is  $4.5 \mu\text{Wcm}^{-2}$ .

Measurements of the detector output are made with an amplifier tuned to 800 Hz with a bandwidth of 50 Hz, and referred to open-circuit conditions, i.e., correction is made for the shunting effects of the bias supply impedance and the amplifier impedance.

The figures in brackets which follow responsivity,  $D^*$  and N.E.P. refer to the test conditions, for example,  $D^*$  (5.3  $\mu\text{m}$ , 800, 1) denotes monochromatic radiation incident on the detector of wavelength 5.3  $\mu\text{m}$ , modulation frequency 800 Hz, an electronic bandwidth of 1 Hz.

$D^*$  and N.E.P.

These are figures of merit for the materials of detectors and are fully discussed in most textbooks on infrared.

$E^*$  is defined in the expression:

$$D^* = \frac{\frac{V_s}{V_n} \times [A(\Delta f)]^{1/2}}{W}$$

where  $V_s$  = Signal voltage across detector terminals

$V_n$  = Noise voltage across detector terminals

$A$  = Detector area

$(\Delta f)$  = Bandwidth of measuring amplifier

$W$  = Radiation power incident on detector sensitive element (r.m.s. value, in watts)

The Noise Equivalent Power (N.E.P.) is related to  $D^*$  by the expression:

$$\text{N.E.P.} = \frac{(A)^{1/2}}{D^*}$$

Variation of performance with bias current

Both signal and noise vary with bias current in this type of cell. Typical curves are shown on page 5. At high currents the noise increases more rapidly than the signal, and therefore the signal to noise ratio has a peak value at some optimum current, which will vary slightly from cell to cell.

## 2. Time constant

Detector time constant figures are based on the response to a step function in the incident radiation. Quoted times indicate the interval between the moment the radiation is cut off and the output falling to 63% of its peak value.



NOTES (continued)

3. Warnings

- a. The resistance of the cell at room temperature is three orders of magnitude less than at the operating temperature (77 K). Care should therefore be taken to ensure that the device is not allowed to reach room temperature while still biased, if any form of low impedance is employed.
- b. If provision is made for cells to be plugged into the bias current and amplifier, steps must be taken to limit the current available from the amplifier input capacitor. This current can be excessive at the instant of plugging in the cell.  
A zener diode can be used to limit the voltage developed across the input capacitor as shown in the diagram.

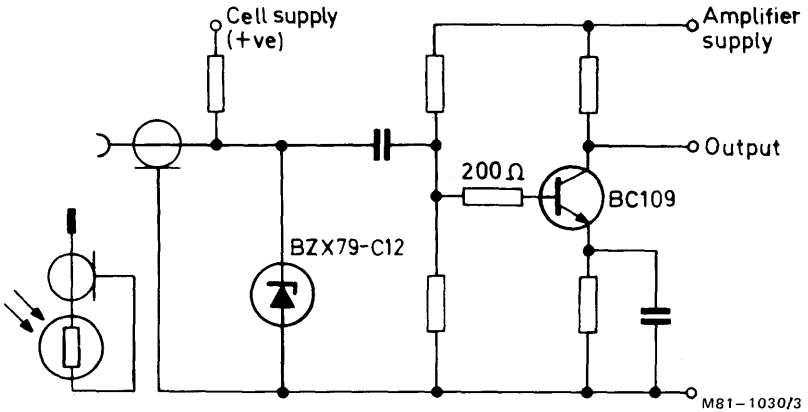

- c. The dewar vessel must always be completely dry before being refilled with liquid nitrogen. In humid conditions, water vapour may condense at the top of the dewar. Should this occur, the remaining liquid nitrogen should be allowed to boil off, the ice should be removed carefully and precautions taken to avoid a recurrence. In very humid conditions the window should be purged with a clean dry gas.

4. Low Frequency Noise

This will be minimised by use of non-absorbent cotton wool placed in the bottom of the dewar. The recommended quantity is 40 mg.

The issue of the information contained in this publication does not imply any authority or licence for the utilisation of any patented feature.



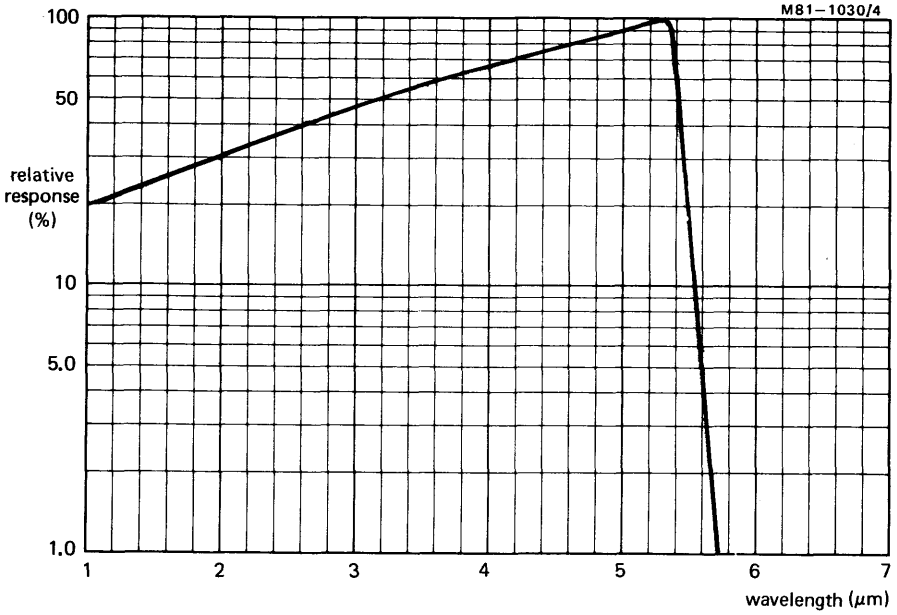

Typical spectral response

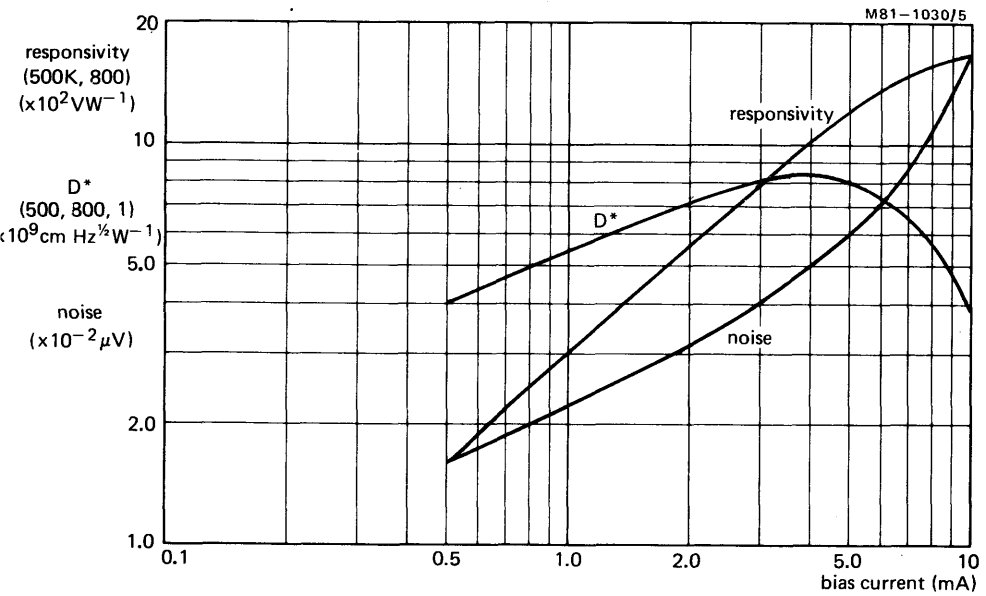

Typical black body performance as a function of bias current





## INFRARED DETECTOR

Indium antimonide photoconductive element mounted in a glass dewar vessel and cooled by liquid nitrogen. It is sensitive to infrared radiation extending to 5.6  $\mu\text{m}$  and is intended for use with modulated or pulsed radiation.

### QUICK REFERENCE DATA

Wavelength at peak response	5.3	$\mu\text{m}$
Operating temperature	77	K
$D^*$ (500 K, 800, 1) min.	$7.2 \times 10^9$	$\text{cmHz}^{1/2}\text{W}^{-1}$
Time constant, typical	5	$\mu\text{s}$
Element dimensions	$4.0 \times 4.0$	mm

This data must be read in conjunction with GENERAL SAFETY RECOMMENDATIONS – OPTOELECTRONIC DEVICES

### PRODUCT SAFETY

Modern high technology materials have been used in the manufacture of this device to ensure high performance. Some of these materials are toxic in certain circumstances. Mechanical or electrical damage is unlikely to give rise to any hazard, but toxic vapours may be generated if the device is heated to destruction. Disposal of large quantities should therefore be carried out in accordance with the Deposit of Poisonous Waste Act 1972 and the Control of Pollution Act 1974, or with the latest legislation.

### MECHANICAL DATA

Dimensions in mm

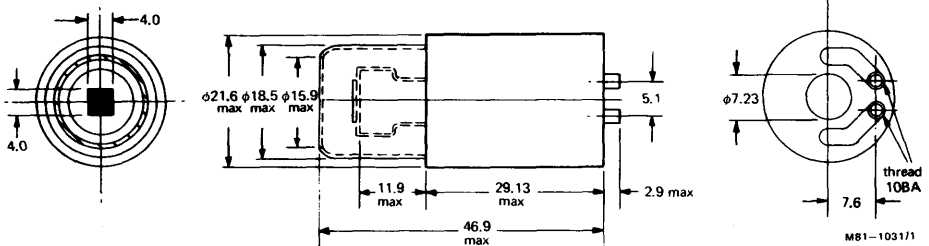

**RATINGS**

Limiting values in accordance with the Absolute Maximum System (IEC134)

Bias current at 77 K	I	max.	15	mA
Storage temperature range	T <sub>stg</sub>		-55 to +55	°C
Operating temperature			77	K

**CHARACTERISTICS** (cooled to 77 K under conditions specified in note 1)

Wavelength at peak response	λ <sub>pk</sub>		5.3	μm
Spectral response range (see page 5)			visible to 5.6	μm
Cell resistance range			1.0 to 5.0	kΩ
Time constant, note 2		typ.	5	μs
Boil off time of bulk liquid nitrogen		min.	10	minutes
		typ.	12	minutes

**BLACK BODY PERFORMANCE, 500 K, note 1**

Responsivity (500 K, 800)	min.	0.5 × 10 <sup>3</sup>	VW <sup>-1</sup>
	typ.	0.8 × 10 <sup>3</sup>	VW <sup>-1</sup>
D* (500 K, 800, 1)	min.	7.2 × 10 <sup>9</sup>	cmHz <sup>1/2</sup> W <sup>-1</sup>
	typ.	8.0 × 10 <sup>9</sup>	cmHz <sup>1/2</sup> W <sup>-1</sup>
N.E.P. (500 K, 800, 1)	typ.	5.0 × 10 <sup>-11</sup>	WHz <sup>-1/2</sup>
	max.	5.5 × 10 <sup>-11</sup>	WHz <sup>-1/2</sup>

**MONOCHROMATIC PERFORMANCE, note 1**

Responsivity (5.3 μm, 800)	typ.	3.8 × 10 <sup>3</sup>	VW <sup>-1</sup>
D* (5.3 μm, 800, 1)	typ.	4.0 × 10 <sup>10</sup>	cmHz <sup>1/2</sup> W <sup>-1</sup>
N.E.P. (5.3 μm, 800, 1)	typ.	1.0 × 10 <sup>-11</sup>	WHz <sup>-1/2</sup>





## NOTES

## 1. Test conditions

The detector is cooled to 77 K by filling the dewar vessel with liquid nitrogen, or by use of a liquid transfer system. An optimum bias of 3 mA is applied. The sensitive element is situated at a distance of 264 mm from a black body source limited by an aperture of 3 mm diameter. The radiation path is interrupted at 800 Hz by a chopper blade at ambient temperature. Under these conditions the r.m.s. power at the element (chopping factor 2.2) is  $4.5 \mu\text{Wcm}^{-2}$ .

Measurements of the detector output are made with an amplifier tuned to 800 Hz with a bandwidth of 50 Hz, and referred to open-circuit conditions, i.e., correction is made for the shunting effects of the bias supply impedance and the amplifier impedance.

The figures in brackets which follow responsivity,  $D^*$  and N.E.P. refer to the test conditions, for example,  $D^*$  (5.3  $\mu\text{m}$ , 800, 1) denotes monochromatic radiation incident on the detector of wavelength 5.3  $\mu\text{m}$ , modulation frequency 800 Hz, an electronic bandwidth of 1 Hz.

$D^*$  and N.E.P.

These are figures of merit for the materials of detectors and are fully discussed in most textbooks on infrared.

$D^*$  is defined in the expression:

$$D^* = \frac{V_s}{V_n} \times [A (\Delta f)]^{1/2} \\ W$$

where  $V_s$  = Signal voltage across detector terminals

$V_n$  = Noise voltage across detector terminals

$A$  = Detector area

$(\Delta f)$  = Bandwidth of measuring amplifier

$W$  = Radiation power incident on detector sensitive element (r.m.s. value, in watts)

The Noise Equivalent Power (N.E.P.) is related to  $D^*$  by the expression:

$$\text{N.E.P.} = \frac{(A)^{1/2}}{D^*}$$

Variation of performance with bias current

Both signal and noise vary with bias current in this type of cell. Typical curves are shown on page 5. At high currents the noise increases more rapidly than the signal, and therefore the signal to noise ratio has a peak value at some optimum current, which will vary slightly from cell to cell.

## 2. Time constant

Detector time constant figures are based on the response to a step function in the incident radiation. Quoted times indicate the interval between the moment the radiation is cut off and the output falling to 63% of its peak value.



NOTES (continued)

3. Warnings

- a. The resistance of the cell at room temperature is three orders of magnitude less than at the operating temperature (77 K). Care should therefore be taken to ensure that the device is not allowed to reach room temperature while still biased, if any form of low impedance biasing is employed.
- b. If provision is made for cells to be plugged into the bias current and amplifier, steps must be taken to limit the current available from the amplifier input capacitor. This current can be excessive at the instant of plugging in the cell.

A zener diode can be used to limit the voltage developed across the input capacitor as shown in the diagram.

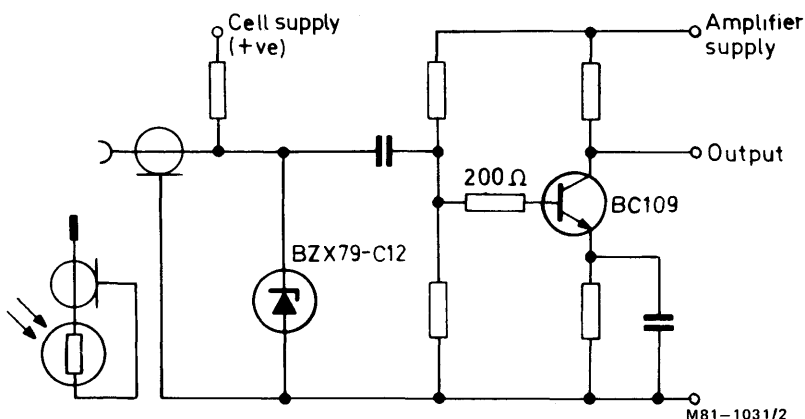

- c. The dewar vessel must always be completely dry before being refilled with liquid nitrogen. In humid conditions, water vapour may condense at the top of the dewar. Should this occur, the remaining liquid nitrogen should be allowed to boil off, the ice should be removed carefully and precautions taken to avoid a recurrence. In very humid conditions the window should be purged with a clean dry gas.

4. Low Frequency Noise

This will be minimised by use of non-absorbent cotton wool placed in the bottom of the dewar. The recommended quantity is 16 mg.

The issue of the information contained in this publication does not imply any authority or licence for the utilisation of any patented feature.



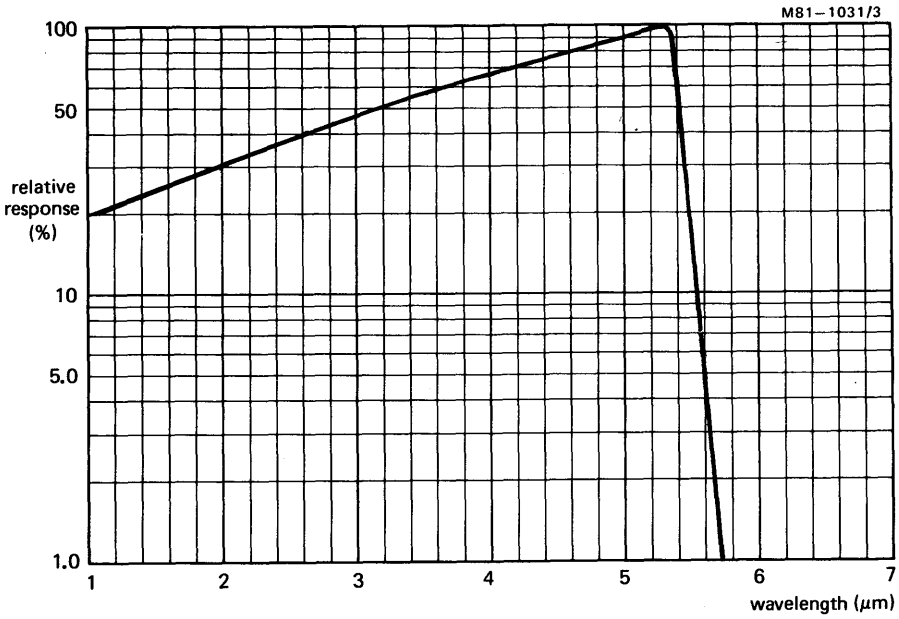

Typical spectral response

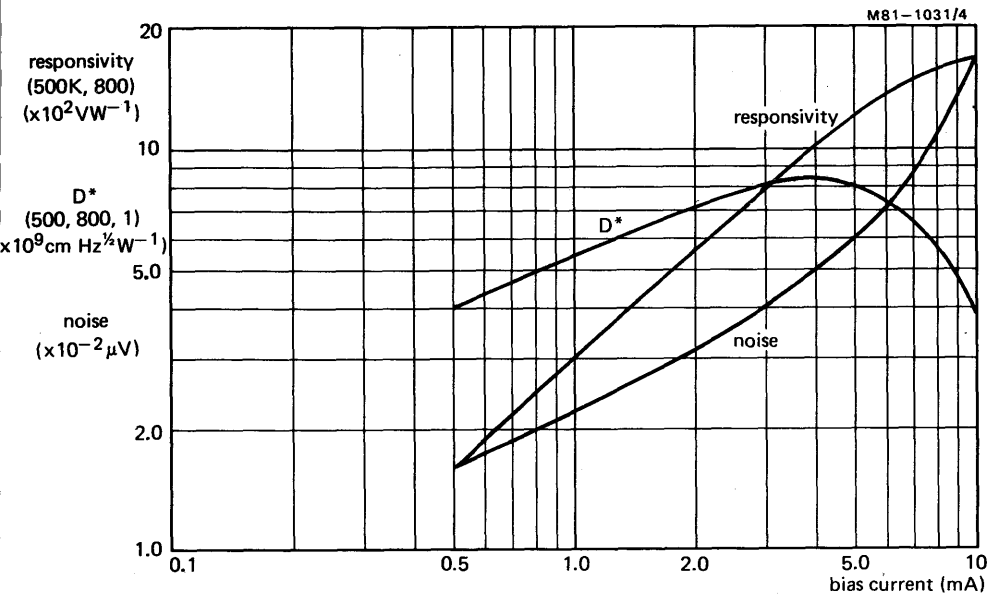

Typical black body performance as a function of bias current



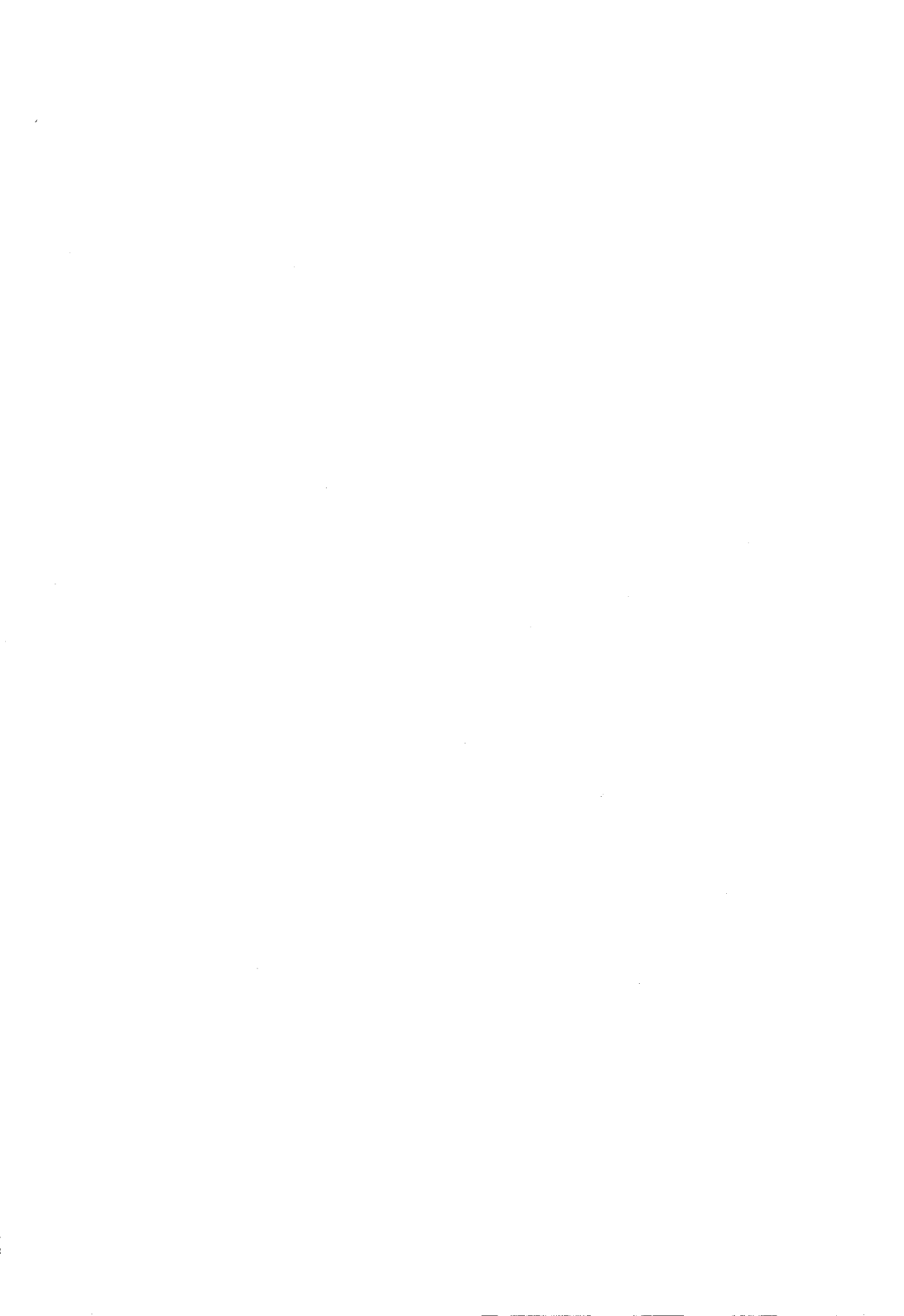

## INFRARED DETECTOR

Indium antimonide photoconductive element mounted in a glass dewar vessel and cooled by liquid nitrogen. It is sensitive to infrared radiation extending to  $5.6 \mu\text{m}$  and is intended for use with modulated or pulsed radiation.

A radiation shield is fitted to give an optical field of view of 60 degrees.

### QUICK REFERENCE DATA

Wavelength at peak response		5.3	$\mu\text{m}$
Operating temperature		77	K
$D^*$ ( $5.3 \mu\text{m}$ , 800, 1) monochromatic performance	typ.	$1.0 \times 10^{11}$	$\text{cmHz}^{1/2}\text{W}^{-1}$
Time constant	typ.	2.5	$\mu\text{s}$
Element dimensions		$0.5 \times 0.5$	mm

This data must be read in conjunction with GENERAL SAFETY RECOMMENDATIONS – OPTOELECTRONIC DEVICES

### PRODUCT SAFETY

Modern high technology materials have been used in the manufacture of this device to ensure high performance. Some of these materials are toxic in certain circumstances. Mechanical or electrical damage is unlikely to give rise to any hazard, but toxic vapours may be generated if the device is heated to destruction. Disposal of large quantities should therefore be carried out in accordance with the Deposit of Poisonous Waste Act 1972 and the Control of Pollution Act 1974, or with the latest legislation.

### MECHANICAL DATA

Dimensions in mm

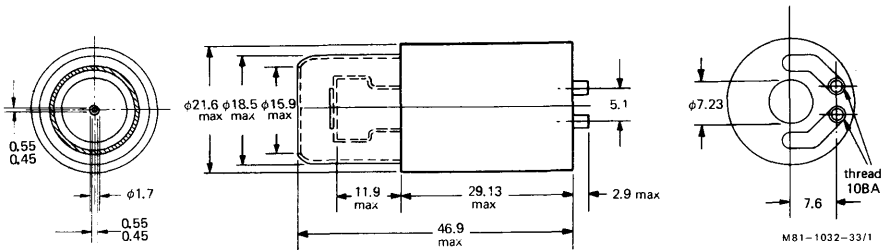

**RATINGS**

Limiting values in accordance with the Absolute Maximum System (IEC134)

Bias current at 77 K	I	max.	5.0	mA
Storage temperature range	T <sub>stg</sub>		-55 to +55	°C
Operating temperature			77	K

**CHARACTERISTICS** (cooled to 77 K under conditions specified in note 1)

**SPECTRAL RESPONSE**

Wavelength at peak response			5.3	μm
Spectral response range (see page 5)			extends to 5.6	μm
Cell resistance range			1.2 to 3.5	kΩ
Time constant, note 2		typ.	2.5	μs
		max.	4.0	μs
Boil off time of bulk liquid nitrogen		min.	10	minutes

**BLACK BODY PERFORMANCE, note 1**

Responsivity (500 K)		min.	5.0	mVμW <sup>-1</sup>
		typ.	9.0	mVμW <sup>-1</sup>
D* (500 K, 800, 1)		min.	1.75 x 10 <sup>10</sup>	cmHz <sup>1/2</sup> W <sup>-1</sup>
		typ.	2.0 x 10 <sup>10</sup>	cmHz <sup>1/2</sup> W <sup>-1</sup>
N.E.P. (500 K, 800, 1)		typ.	2.5 x 10 <sup>-12</sup>	WHz <sup>-1/2</sup>
		max.	2.9 x 10 <sup>-12</sup>	WHz <sup>-1/2</sup>

**MONOCHROMATIC PERFORMANCE, note 1**

Responsivity (5.3 μm, 800)		typ.	45	mVμW <sup>-1</sup>
D* (5.3 μm, 800, 1)		typ.	1.0 x 10 <sup>11</sup>	cmHz <sup>1/2</sup> W <sup>-1</sup>
N.E.P. (5.3 μm, 800, 1)		typ.	5.0 x 10 <sup>-13</sup>	WHz <sup>-1/2</sup>



## NOTES

## 1. Test conditions

The detector is cooled to 77 K by filling the dewar vessel with liquid nitrogen or by inserting a miniature Joule-Thompson cooler, or by the use of a liquid transfer system. An optimum bias of 0.75 mA to 1.5 mA is applied. The sensitive element is situated at a distance of 164 mm from a 500 K black body source limited by an aperture of 3 mm diameter.

The radiation path is interrupted at 800 Hz by a chopper blade at ambient temperature. Under these conditions the r.m.s. power at the element (chopping factor 2.2) is  $4.5 \mu\text{Wcm}^{-2}$ .

Measurements of the detector output are made with an amplifier tuned to 800 Hz with a bandwidth of 50 Hz, and are referred to open circuit conditions, i.e. correction is made for the shunting effects of the bias supply impedance and the amplifier input impedance. Under these conditions, the device will exhibit a minimum signal-to-noise ratio of 400:1.

The values quoted at  $5.3 \mu\text{m}$  are calculated from measurements made with the 500 K black body source, assuming the detector to have a typical spectral response.

$D^*$  and N.E.P.

These are the figures of merit for the materials of detectors and are fully discussed in most textbooks on infrared.

$D^*$  is defined in the expression:

$$D^* = \frac{V_s}{V_n} \times [A(\Delta f)]^{1/2} / W$$

where  $V_s$  = Signal voltage across detector terminals

$V_n$  = Noise voltage across detector terminals

$A$  = Detector Area

$(\Delta f)$  = Bandwidth of measuring amplifier

$W$  = Radiation power incident on detector sensitive element (r.m.s. value, in watts).

The figures in brackets which follow  $D^*$  refer to the test conditions e.g.  $D^*$  (5.3  $\mu\text{m}$ , 800, 1) denotes monochromatic radiation incident on the detector of wavelength 5.3  $\mu\text{m}$ , modulation frequency 800 Hz, an electronic bandwidth of 1 Hz.

The Noise Equivalent Power (N.E.P. is related to  $D^*$  by the expression:

$$\text{N.E.P.} = \frac{(A)^{1/2}}{D^*}$$

Variation of performance with bias current

Both signal and noise vary with bias current in this type of cell. Typical curves are shown on page 5. At high currents the noise increases more rapidly than the signal, and therefore the signal to noise ratio has a peak value at some optimum current, which will vary slightly from cell to cell. A typical value is 1 mA.

## 2. Time constant

Detector time constant figures are based on the response to a step function of incident radiation. Quoted times indicate the interval between the moment of application of radiation and the output pulse reaching 63% of its peak value.



NOTES (continued)

3. Warnings

- a. The dewar vessel must always be completely dry before being refilled with liquid nitrogen or inserting the miniature Joule-Thompson cooler. Under this type of condition the front window should be purged with a clean dry gas. In very humid conditions, water vapour may condense at the top of the dewar vessel. Should this occur, the remaining liquid nitrogen should be allowed to boil off, the ice should be carefully removed and precautions taken to avoid a recurrence.
- b. If provision is made for cells to be plugged into the bias circuit and amplifier, steps must be taken to limit the current available from the amplifier input capacitor. This current can be excessive at the instant of plugging in the cell.  
A zener diode can be used to limit the voltage developed across the input capacitor as shown in the diagram.

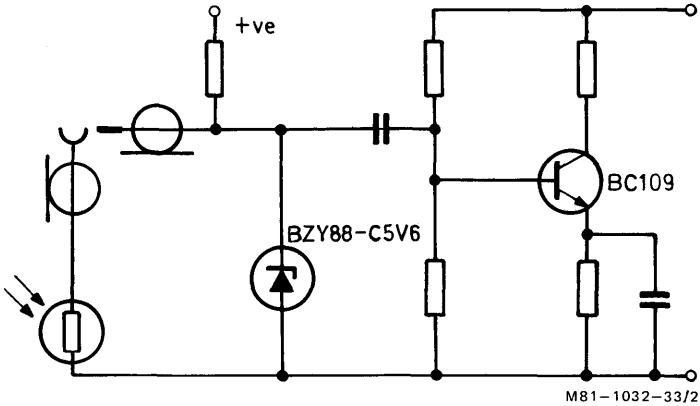

- c. The resistance of the cell at room temperature is approximately three orders of magnitude less than that at the operating temperature (77 K). Care should therefore be taken to ensure that the device is not allowed to reach room temperature while still biased, if any form of low impedance biasing is employed.

4. Cooling by Joule-Thompson cooler.

An alternative method of cooling the cell is by the use of a miniature Joule-Thompson cooler. This device operates from a high pressure clean dry gas supply (either nitrogen or air).

5. Low frequency noise

This will be minimized by use of non absorbent cotton wool placed in the bottom of the dewar vessel. The recommended quantity is 16 mg and it should be positioned as shown in the drawing.

The issue of the information contained in this publication does not imply any authority or licence for the utilisation of any patented feature.





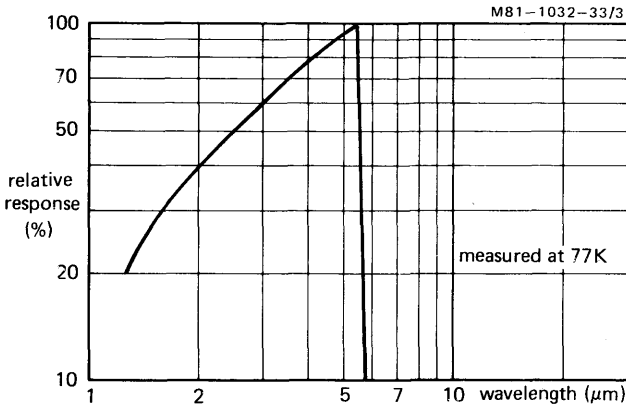

Typical spectral response

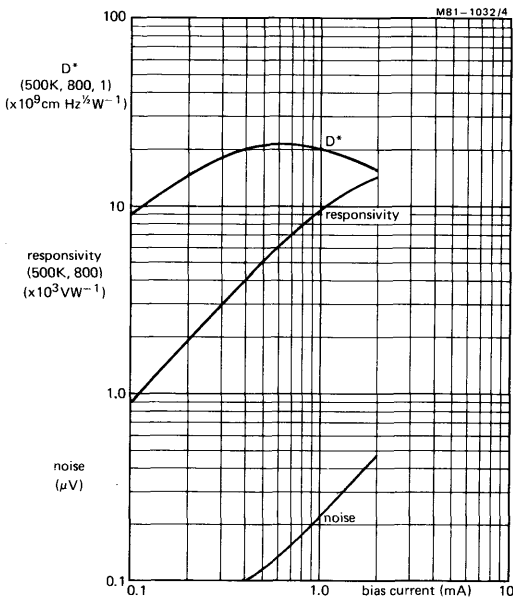

Typical black body performance as a function of bias current





## INFRARED DETECTOR

Indium antimonide photoconductive element mounted in a glass dewar vessel and cooled by liquid nitrogen.

It is sensitive to infrared radiation extending to 5.6  $\mu\text{m}$  and is intended for use with modulated or pulsed radiation.

A radiation shield is fitted to give an optical field of view of 60 degrees.

### QUICK REFERENCE DATA

Wavelength at peak response		5.3	$\mu\text{m}$
Operating temperature		77	K
D* (5.3 $\mu\text{m}$ , 800, 1) monochromatic performance	typ.	$0.75 \times 10^{11}$	$\text{cm Hz}^{1/2} \text{W}^{-1}$
Time constant	typ.	2.5	$\mu\text{s}$
Element dimensions		0.5 x 0.5	mm

This data must be read in conjunction with GENERAL SAFETY RECOMMENDATIONS – OPTOELECTRONIC DEVICES

### PRODUCT SAFETY

Modern high technology materials have been used in the manufacture of this device to ensure high performance. Some of these materials are toxic in certain circumstances. Mechanical or electrical damage is unlikely to give rise to any hazard, but toxic vapours may be generated if the device is heated to destruction. Disposal of large quantities should therefore be carried out in accordance with the Deposit of Poisonous Waste Act 1972 and the Control of Pollution Act 1974, or with the latest legislation.

### MECHANICAL DATA

Dimensions in mm

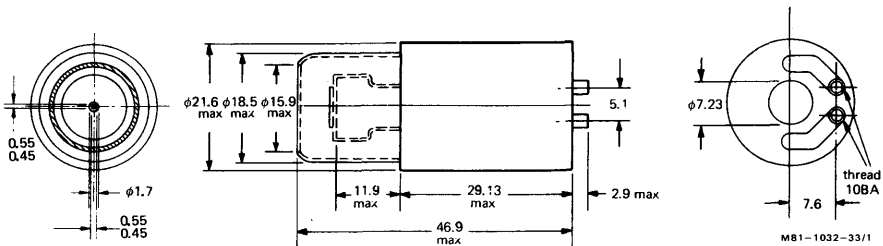

**RATINGS**

Limiting values in accordance with the Absolute Maximum System (IEC134)

Bias current at 77 K	I	max.	5.0	mA
Storage temperature range	T <sub>stg</sub>		-55 to +55	°C
Operating temperature			77	K

**CHARACTERISTICS** (cooled to 77 K under conditions specified in note 1)

**SPECTRAL RESPONSE**

Wavelength at peak response			5.3	μm
Spectral response range (see page 5)			extends to 5.6	μm
Cell resistance range			1.2 to 3.5	kΩ
Time constant, note 2	typ.		2.5	μs
	max.		4.0	μs
Boil off time of bulk liquid nitrogen		min.	10	minutes

**BLACK BODY PERFORMANCE, note 1**

Responsivity (500 K)	min.		5.0	mVμW <sup>-1</sup>
	typ.		9.0	mVμW <sup>-1</sup>
D* (500 K, 800, 1)	min.		1.0 x 10 <sup>10</sup>	cmHz <sup>1/2</sup> W <sup>-1</sup>
	typ.		1.5 x 10 <sup>10</sup>	cmHz <sup>1/2</sup> W <sup>-1</sup>
N.E.P. (500 K, 800, 1)	typ.		3.3 x 10 <sup>-12</sup>	WHz <sup>-1/2</sup>
	max.		5.0 x 10 <sup>-12</sup>	WHz <sup>-1/2</sup>

**MONOCHROMATIC PERFORMANCE, note 1**

Responsivity (5.3 μm, 800, 1)	typ.		45	mVμW <sup>-1</sup>
D* (5.3 μm, 800, 1)	typ.		0.75 x 10 <sup>11</sup>	cmHz <sup>1/2</sup> W <sup>-1</sup>
N.E.P. (5.3 μm, 800, 1)	typ.		6.7 x 10 <sup>-13</sup>	WHz <sup>-1/2</sup>



## NOTES

## 1. Test conditions

The detector is cooled to 77 K by filling the dewar vessel with liquid nitrogen or by inserting a miniature Joule-Thompson cooler, or by the use of a liquid transfer system. An optimum bias of 0.75 mA to 1.5 mA is applied. The sensitive element is situated at a distance of 164 mm from a 500 K black body source limited by an aperture of 3 mm diameter.

The radiation path is interrupted at 800 Hz by a chopper blade at ambient temperature. Under these conditions the r.m.s. power at the element (chopping factor 2.2) is  $4.5 \mu\text{Wcm}^{-2}$ .

Measurements of the detector output are made with an amplifier tuned to 800 Hz with a bandwidth of 50 Hz, and are referred to open circuit conditions, i.e. correction is made for the shunting effects of the bias supply impedance and the amplifier input impedance. Under these conditions, the device will exhibit a minimum signal-to-noise ratio of 240:1.

The values quoted at  $5.3 \mu\text{m}$  are calculated from measurements made with the 500 K black body source, assuming the detector to have a typical spectral response.

D\* and N.E.P.

These are the figures of merit for the materials of detectors and are fully discussed in most textbooks on infrared.

D\* is defined in the expression:

$$D^* = \frac{\frac{V_s}{V_n} \times [A(\Delta f)]^{1/2}}{W}$$

where  $V_s$  = Signal voltage across detector terminals

$V_n$  = Noise voltage across detector terminals

A = Detector Area

( $\Delta f$ ) = Bandwidth of measuring amplifier

W = Radiation power incident on detector sensitive element (r.m.s. value, in watts).

The figures in brackets which follow D\* refer to the test conditions e.g. D\* (5.3  $\mu\text{m}$ , 800, 1) denotes monochromatic radiation incident on the detector of wavelength 5.3  $\mu\text{m}$ , modulation frequency 800 Hz, an electronic bandwidth of 1 Hz.

The Noise Equivalent Power (N.E.P.) is related to D\* by the expression:

$$\text{N.E.P.} = \frac{(A)^{1/2}}{D^*}$$

## Variation of performance with bias current

Both signal and noise vary with bias current in this type of cell. Typical curves are shown on page 5. At high currents the noise increases more rapidly than the signal, and therefore the signal to noise ratio has a peak value at some optimum current, which will vary slightly from cell to cell. A typical value is 1 mA.

## 2. Time constant

Detector time constant figures are based on the response to step function of incident radiation.

Quoted times indicate the interval between the moment of application of radiation and the output pulse reaching 63% of its peak value.



NOTES (continued)

3. Warnings

- a. The dewar vessel must always be completely dry before being refilled with liquid nitrogen or inserting the miniature Joule-Thompson cooler. Under this type of condition the front window should be purged with a clean dry gas. In very humid conditions, water vapour may condense at the top of the dewar vessel. Should this occur, the remaining liquid nitrogen should be allowed to boil off, the ice should be carefully removed and precautions taken to avoid a recurrence.
- b. If provision is made for cells to be plugged into the bias circuit and amplifier, steps must be taken to limit the current available from the amplifier input capacitor. This current can be excessive at the instant of plugging in the cell.  
A zener diode can be used to limit the voltage developed across the input capacitor as shown in the diagram.

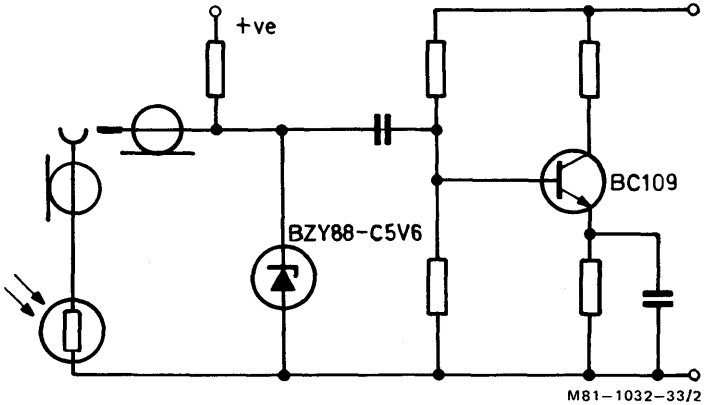

- c. The resistance of the cell at room temperature is approximately three orders of magnitude less than that at the operating temperature (77 K). Care should therefore be taken to ensure that the device is not allowed to reach room temperature while still biased, if any form of low impedance biasing is employed.

4. Cooling by Joule-Thompson cooler

An alternative method of cooling the cell is by the use of a miniature Joule-Thompson cooler. This device operates from a high pressure clean dry gas supply (either nitrogen or air).

5. Low frequency noise

This will be minimized by use of non absorbent cotton wool placed in the bottom of the dewar vessel. The recommended quantity is 16 mg and it should be positioned as shown in the drawing.

The issue of the information contained in this publication does not imply any authority or licence for the utilisation of any patented feature.



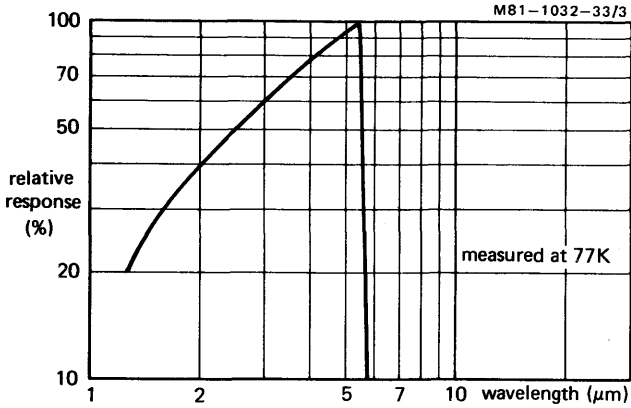

Typical spectral response

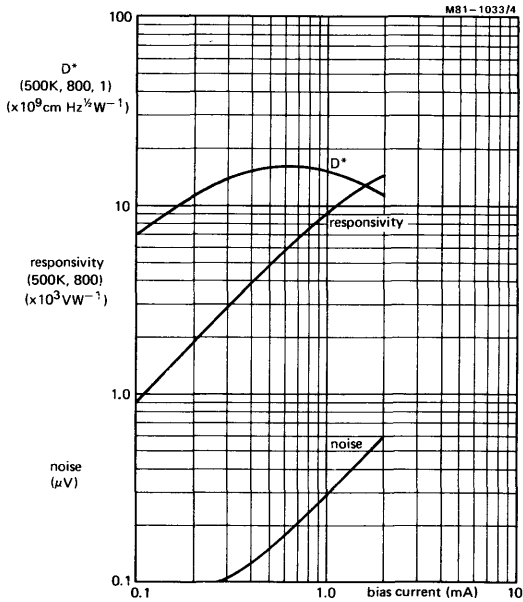

Typical black body performance as a function of bias current







## PYROELECTRIC INFRARED DETECTORS

This is an infrared sensitive device, combined with a pre-amplifier which is stabilized to overcome d.c. drift due to thermal changes. It is sealed in a low-profile TO-5 can with a choice of window.

### QUICK REFERENCE DATA

	RPY86	RPY87	
Spectral response	$6.5 \pm 0.5$ to $> 14$	$1.0$ to $> 15$	$\mu\text{m}$
Responsivity	( $10 \mu\text{m}$ , 10) typ. 600	( $6 \mu\text{m}$ , 10) 500	$\text{VW}^{-1}$
Noise Equivalent Power (N.E.P.),	( $10 \mu\text{m}$ , 10, 1) typ. $0.9 \times 10^{-9}$	( $6 \mu\text{m}$ , 10, 1) $1.05 \times 10^{-9}$	$\text{WHz}^{-1/2}$
Element dimensions		$2 \times 1$	mm
Field of view	typ. 112		degrees
Operating voltage		9	V
Optimum operating frequency range		0.1 to 1000	Hz

This data must be read in conjunction with GENERAL SAFETY RECOMMENDATIONS – OPTOELECTRONIC DEVICES

### MECHANICAL DATA

Dimensions in mm

SOT-49E (low profile TO-5)

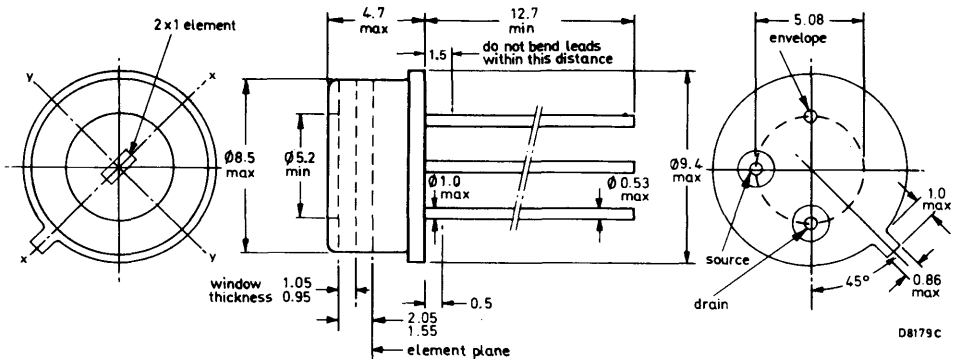

### PRODUCT SAFETY

Modern high technology materials have been used in the manufacture of this device to ensure high performance. Some of these materials are toxic in certain circumstances. Mechanical or electrical damage is unlikely to give rise to any hazard, but toxic vapours may be generated if the device is heated to destruction. Disposal of large quantities should therefore be carried out in accordance with the Deposit of Poisonous Waste Act 1972 and the Control of Pollution Act 1974, or with the latest legislation.

**RATINGS**

Limiting values in accordance with the Absolute Maximum System (IEC134)

Operating voltage up to 100 °C	max.	30	V
Temperature, operating	max.	+100	°C
	min.	-40	°C
Temperature, storage	max.	+100	°C
	min.	-40	°C

**SOLDERING**

- When making soldered connections to the leads, a thermal shunt must be used.
- It is essential that any mains operated soldering iron should be both screened and earthed. Failure to observe these precautions could lead to the introduction of line voltage and possible damage to the device.

**CHARACTERISTICS** (at 25 ± 3 °C and with recommended test circuit)

RPY86	min.	typ.	max.	
N.E.P. (500 K, 10, 1)	—	2.0 x 10 <sup>-9</sup>	—	WHz <sup>-1/2</sup>
N.E.P. (10 μm, 10, 1) notes 1 and 4	—	0.9 x 10 <sup>-9</sup>	3 x 10 <sup>-9</sup>	WHz <sup>-1/2</sup>
Responsivity (500 K, 10)	—	430	—	VW <sup>-1</sup>
Responsivity (10 μm, 10) notes 1 and 4	425	600	—	VW <sup>-1</sup>
Spectral response	6.5 ± 0.5	—	> 14	μm
Field of view note 2	—	112	—	degrees
Operating voltage note 3	8	9	10	V

**RPY87**

N.E.P. (500 K, 10, 1) or (6 μm, 10, 1), notes 1 and 4	—	1.05 x 10 <sup>-9</sup>	3 x 10 <sup>-9</sup>	WHz <sup>-1/2</sup>
Responsivity (500 K, 10) or (6 μm, 10), notes 1 and 4	376	500	—	VW <sup>-1</sup>
Spectral response	1	—	> 15	μm
Field of view note 2	—	112	—	degrees
Operating voltage note 3	8	9	10	V

**Notes**

- These characteristics apply throughout the spectral response range.
- Field of view to 50% of the maximum responsivity level.
- The detector will operate outside the quoted range but may have a degraded performance.
- For performance as a function of frequency and temperature, see pages 6 to 9.



## TEST CIRCUIT

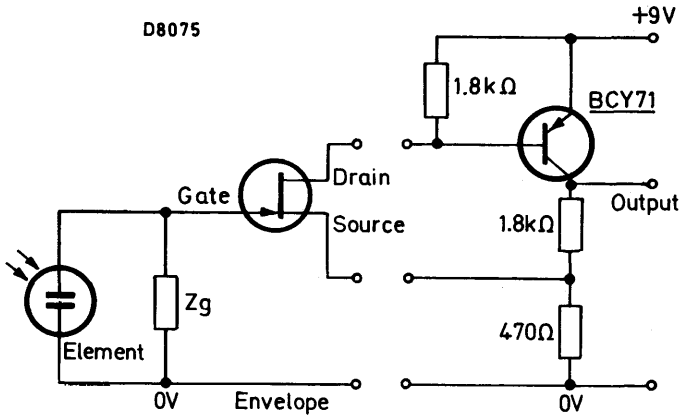

## OPERATING NOTES

1. The detector may be supplied with a black plastic cap to protect the window. This cap must be removed before operation.
2. The case potential must not be allowed to become positive with respect to the other two terminals.
3. The shape of the electrical output waveform is the integral of the incident radiation waveform.
4. It is inadvisable to operate the detector at mains related frequencies.
5. To avoid the possibility of optical microphony, the detector must be firmly mounted.
6. Use recommended circuit for low noise operation.
7. An increase in temperature of the element will produce a negative going signal at the output.
8. For simplicity of operation, a source follower may be used where noise is not a problem. This may be achieved with a  $22\text{ k}\Omega$  resistor between source and envelope with the positive supply taken to the drain terminal. This will give a voltage gain of approximately 0.9.

## DEFINITIONS

1. N.E.P. (Noise Equivalent Power),  $\text{WHz}^{-\frac{1}{2}}$   
This is the r.m.s. value of the incident, chopped, radiant power necessary to produce an r.m.s. signal to r.m.s. noise ratio of unity. The r.m.s. noise refers to the value calculated for unit square root bandwidth  $\text{VHz}^{-\frac{1}{2}}$
2. Responsivity,  $\text{VW}^{-1}$   
This is the ratio of the r.m.s. signal in volts to the r.m.s. value of the incident, chopped, radiant power.



APPLICATION INFORMATION

- Optional additional stage for extra gain

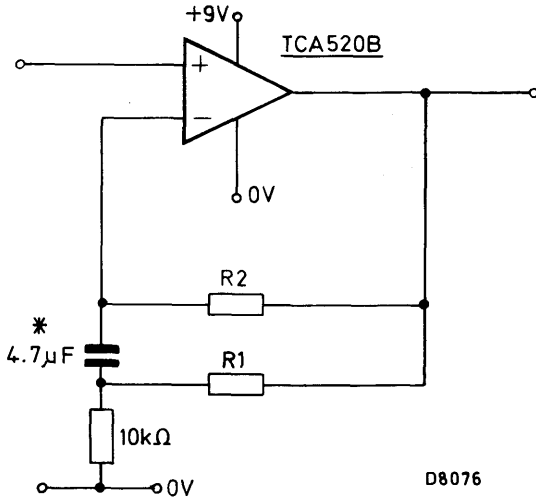

Recommended component values for various gains

Gain x	R <sub>1</sub> kΩ	R <sub>2</sub> MΩ
50	560	5.6
20	220	2.2
10	100	1.0

\*this capacitor must be a low leakage type e.g. our 344 series

- The pyroelectric element may be considered as a capacitor whose charge state changes with temperature. It also behaves as a normal capacitor, i.e. its voltage changes with charge. Thus a change of temperature results in a change of charge. It can be seen that, for a given change in amplitude of incident radiation, the resulting change in temperature will decrease as the chopping frequency increases. Thus the voltage change will also decrease with frequency. In addition, there is a 90° phase lag between the thermal and electrical signals. The voltage signal therefore becomes the integral of the radiation signal.

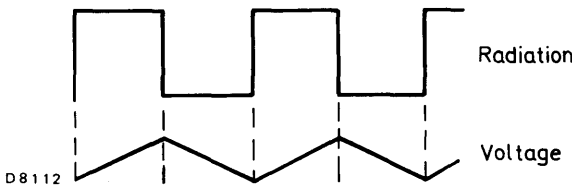

## 3. Temperature slew

The FET used with a pyroelectric detector requires a gate leakage resistor to earth in parallel with the element. This stabilizes its working point. The pyroelectric voltage appearing across this resistor is proportional to the rate of change of temperature.

To ensure a low level of noise current from this resistor, its value should be of the order of  $3 \times 10^{10} \Omega$ .

When the temperature slew rate is  $1^\circ\text{C}/\text{minute}$ , the pyroelectric voltage produced is 1 volt. In a system which is designed to sense microvolts, this is almost certain to cause overload and any a.c. signal superimposed on this d.c. shift will be lost.

Our detectors incorporate a bleed system which acts progressively on the d.c. shift caused by temperature slew. The law is logarithmic.

Thus a slew rate of  $0.1^\circ\text{C}/\text{minute}$  may produce an offset across the sensing element of 200 millivolts,  $1^\circ\text{C}/\text{minute}$  280 millivolts and  $10^\circ\text{C}/\text{minute}$  360 millivolts.

**MECHANICAL AND ENVIRONMENTAL STANDARDS**

As part of the Quality Assurance programme, the detectors are assessed at regular intervals against the requirements of the following IEC standards. The frequency of testing and the limits and conditions for the pre- and post-test measurements are based on those stipulated for the CECC 50 000 series of approved transistors.

				note
IEC 68-2-3	Test Ca	Moisture Resistance, steady state		1
68-2-20	Test T	Solderability		1
68-2-21	Test Ub	Lead Fatigue		1
68-2-1	Test A	Low Temperature Storage		2
68-2-2	Test Ba	High Temperature Storage		2
68-2-14	Test Nb	Change of Temperature (10 cycles)		2
68-2-6	Test Fc (B4)	Vibration, swept frequency		2
68-2-7	Test Ga	Acceleration, steady state		2
68-2-27	Test Ea	Shock		2
68-2-20	Test T	Resistance to Solder Heat		3

## Notes

1. The detectors are checked on a production batch release principle at approximately weekly intervals. This is equivalent to group B.
2. The detectors are checked at quarterly intervals; the storage tests to 2000 hours. This is equivalent to group C.
3. This is an annual check.



RPY86  
RPY87

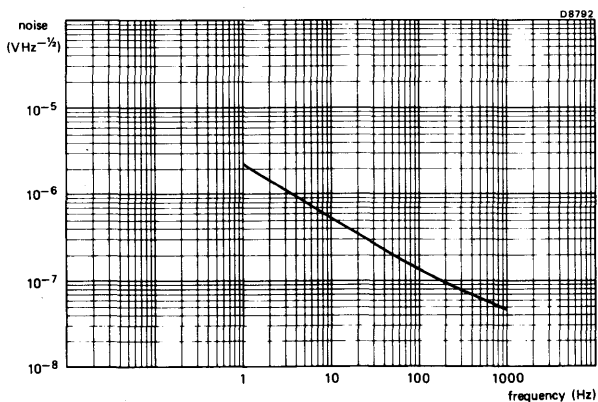
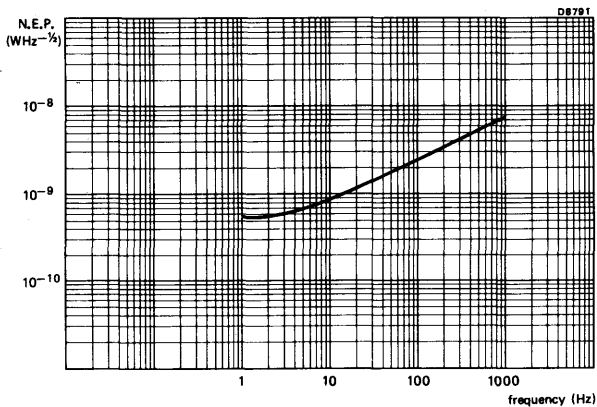
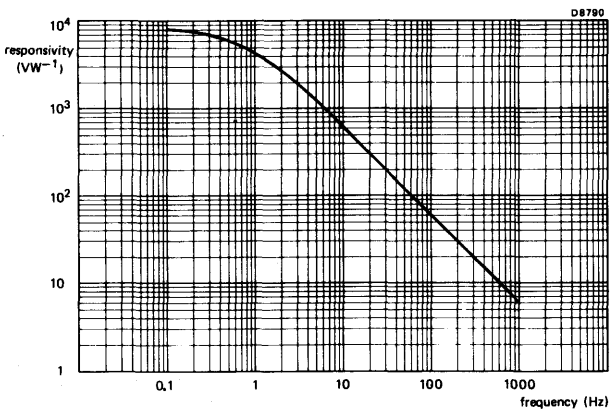

RPY86, typical responsivity, N.E.P., and noise as a function of frequency



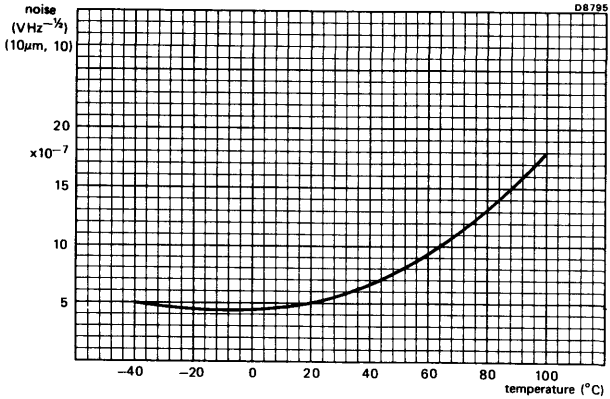
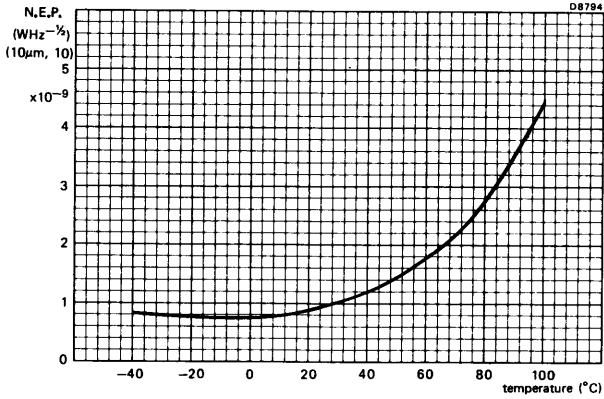
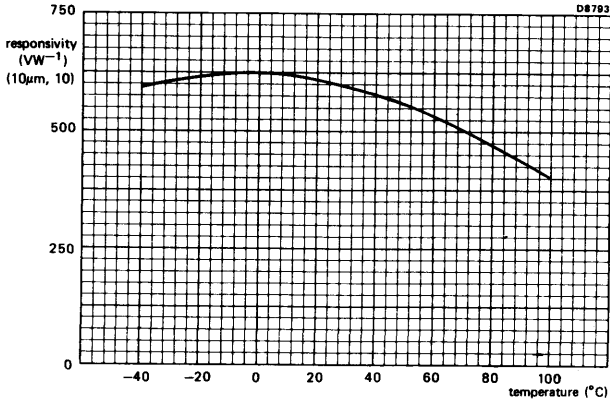

RPY86, typical responsivity, N.E.P., and noise as a function of temperature



RPY86  
RPY87

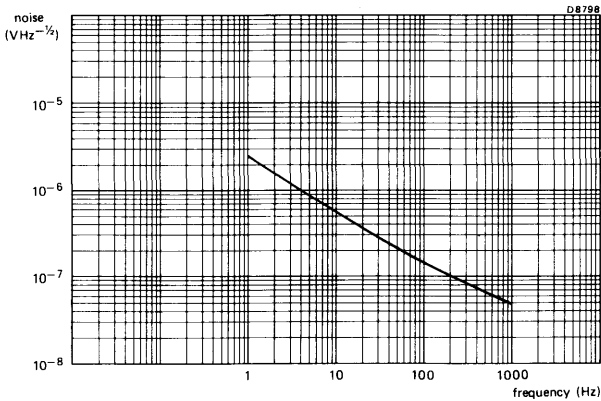
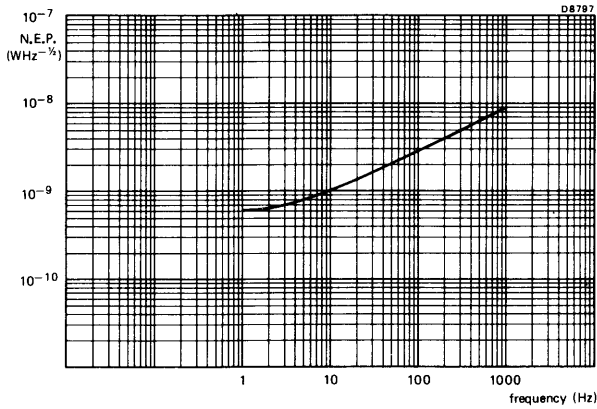
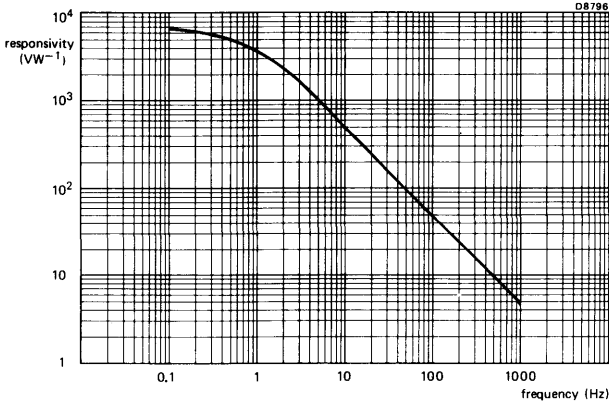

RPY87, typical responsivity, N.E.P., and noise as a function of frequency





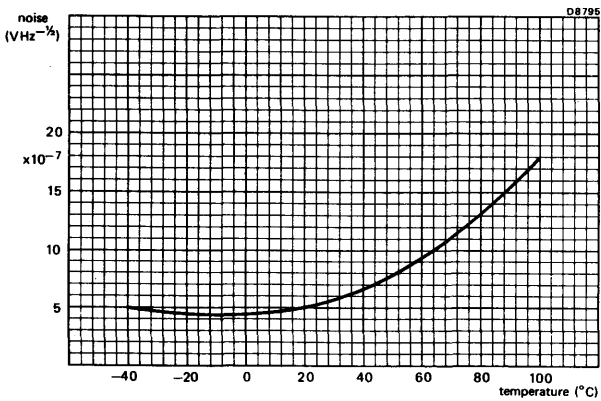
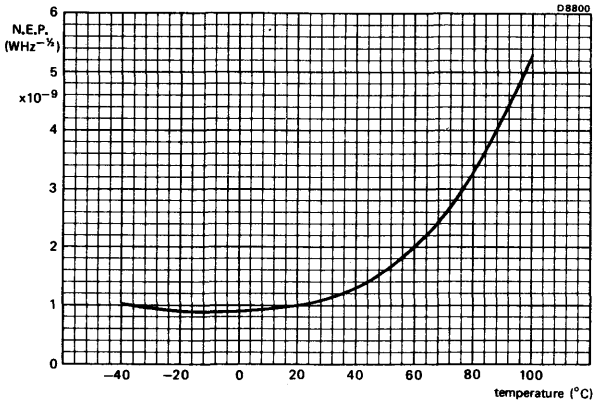
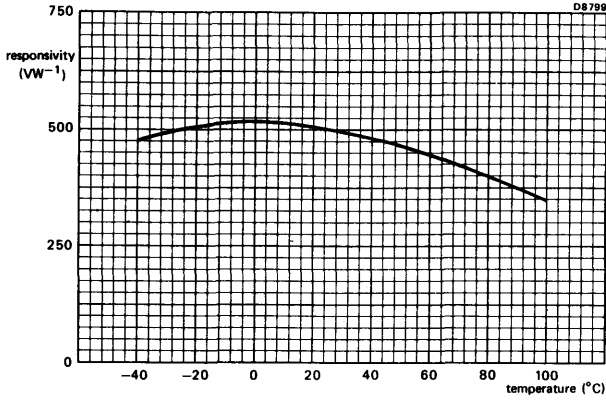

RPY87, typical responsivity, N.E.P., and noise as a function of temperature



POLAR DIAGRAMS

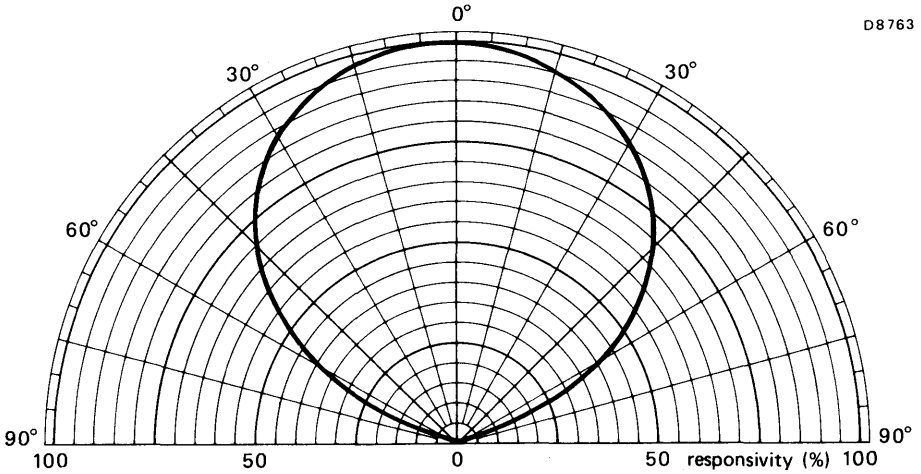

Typical field of view in x-x plane (see mechanical data)

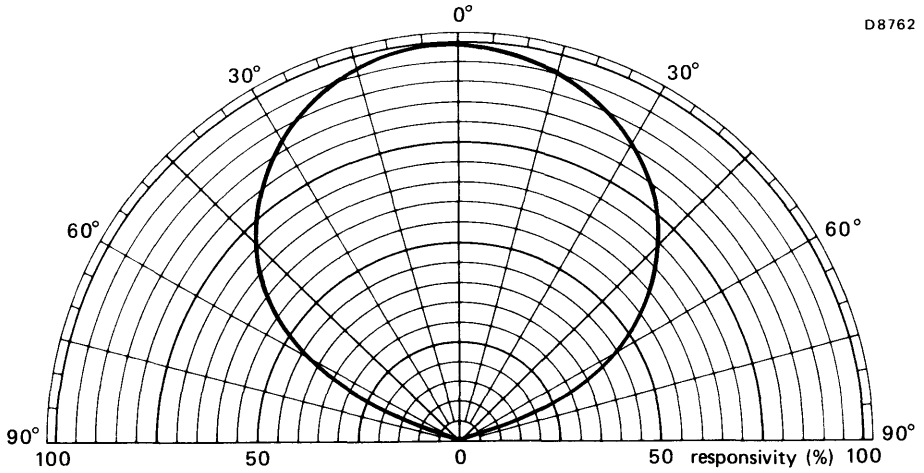

Typical field of view in y-y plane (see mechanical data)



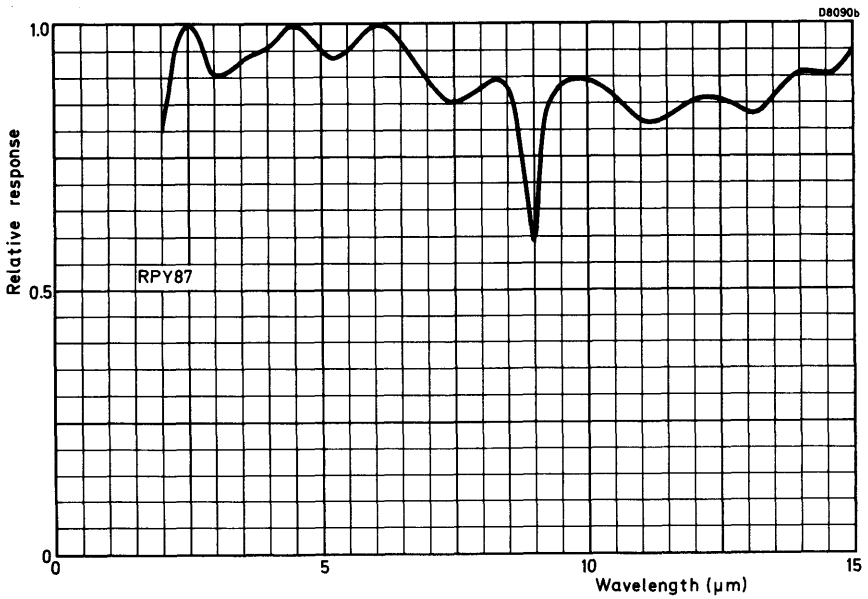
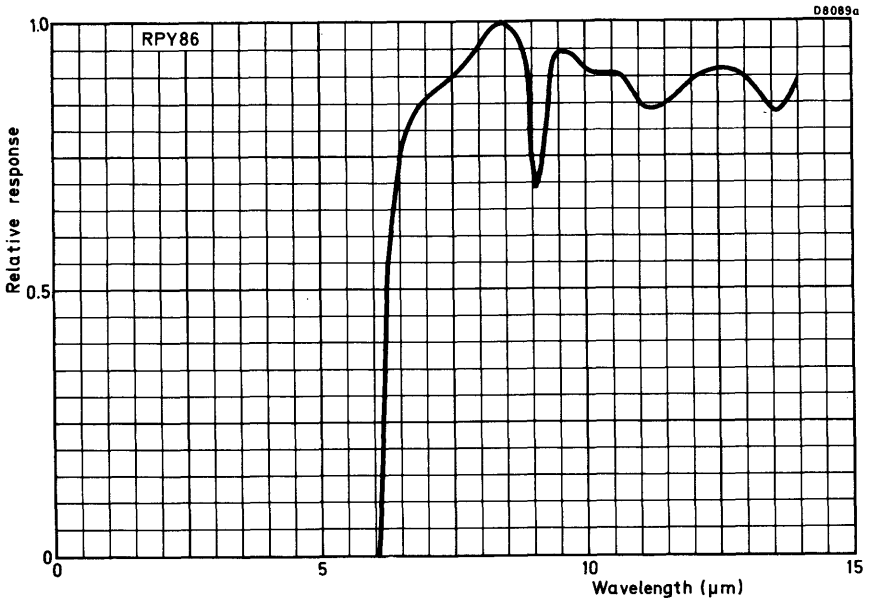

Typical window transmission characteristics





## PYROELECTRIC INFRARED DETECTORS

This is an infrared sensitive device, combined with a pre-amplifier which is stabilized to overcome d.c. drift due to thermal changes. It is sealed in a low-profile TO-5 can with a choice of window.

### QUICK REFERENCE DATA

	RPY88	RPY89	
Spectral response	6.5 ± 0.5 to > 14	1.0 to > 15	μm
Responsivity	(10 μm, 10) typ. 300	(6 μm, 10) 250	VW <sup>-1</sup>
Noise Equivalent Power (N.E.P.) <sup>1</sup>	(10 μm, 10, 1) typ. 1.65 × 10 <sup>-9</sup>	(6 μm, 10, 1) 2.0 × 10 <sup>-9</sup>	WHz <sup>-1/2</sup>
Element dimensions		2 × 2	mm
Field of view	typ. 112		degrees
Operating voltage		9	V
Optimum operating frequency range		0.1 to 1000	Hz

This data must be read in conjunction with GENERAL SAFETY RECOMMENDATIONS – OPTOELECTRONIC DEVICES

### MECHANICAL DATA

Dimensions in mm

SOT-49E (low profile TO-5)

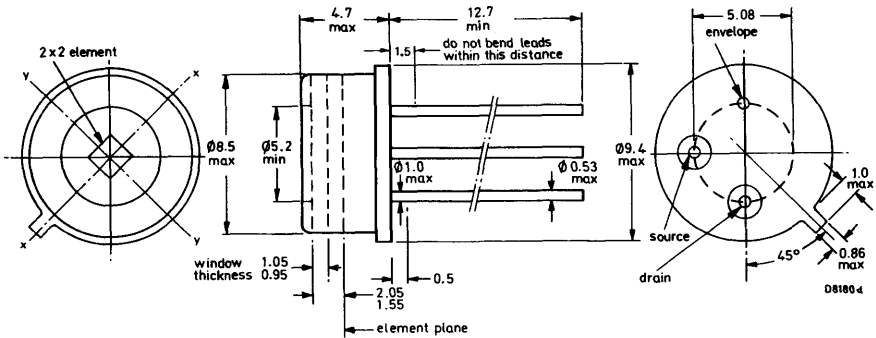

### PRODUCT SAFETY

Modern high technology materials have been used in the manufacture of this device to ensure high performance. Some of these materials are toxic in certain circumstances. Mechanical or electrical damage is unlikely to give rise to any hazard, but toxic vapours may be generated if the device is heated to destruction. Disposal of large quantities should therefore be carried out in accordance with the Deposit of Poisonous Waste Act 1972 and the Control of Pollution Act 1974, or with the latest legislation.



## RATINGS

Limiting values in accordance with the Absolute Maximum System (IEC134)

Operating voltage up to 100 °C	max.	30	V
Temperature, operating	max.	+100	°C
	min.	-40	°C
Temperature, storage	max.	+100	°C
	min.	-40	°C

## SOLDERING

1. When making soldered connections to the leads, a thermal shunt must be used.
2. It is essential that any mains operated soldering iron used should be both screened and earthed. Failure to observe these precautions could lead to the introduction of line voltage and possible damage to the device.

CHARACTERISTICS (at  $25 \pm 3$  °C and with recommended test circuit)

RPY88	min.	typ.	max.	
N.E.P. (500 K, 10, 1)	—	$3.0 \times 10^{-9}$	—	WHz <sup>-1/2</sup>
N.E.P. (10 μm, 10, 1) notes 1 and 4	—	$1.65 \times 10^{-9}$	$3 \times 10^{-9}$	WHz <sup>-1/2</sup>
Responsivity (500 K, 10)	—	215	—	VW <sup>-1</sup>
Responsivity (10 μm, 10) notes 1 and 4	212	300	—	VW <sup>-1</sup>
Spectral response	$6.5 \pm 0.5$	—	> 14	μm
Field of view note 2	—	112	—	degrees
Operating voltage note 3	8	9	10	V

## RPY89

N.E.P. (500 K, 10, 1) or (6 μm, 10, 1), notes 1 and 4	—	$2.0 \times 10^{-9}$	$3 \times 10^{-9}$	WHz <sup>-1/2</sup>
Responsivity (500 K, 10) or (6 μm, 10), notes 1 and 4	188	250	—	VW <sup>-1</sup>
Spectral response	1	—	> 15	μm
Field of view note 2	—	112	—	degrees
Operating voltage note 3	8	9	10	V

## Notes

1. These characteristics apply throughout the spectral response range.
2. Field of view to 50% of the maximum responsivity level.
3. The detector will operate outside the quoted range but may have a degraded performance.
4. For performance as a function of frequency and temperature, see pages 6 to 9.



TEST CIRCUIT

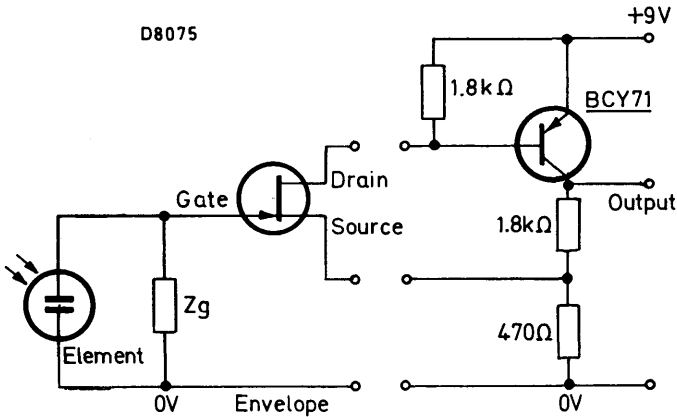

OPERATING NOTES

1. The detector may be supplied with a black plastic cap to protect the window. This cap must be removed before operation.
2. The case potential must not be allowed to become positive with respect to the other two terminals.
3. The shape of the electrical output waveform is the integral of the incident radiation waveform.
4. It is inadvisable to operate the detector at mains related frequencies.
5. To avoid the possibility of optical microphony, the detector must be firmly mounted.
6. Use recommended circuit for low noise operation.
7. An increase in temperature of the element will produce a negative going signal at the output;
8. For simplicity of operation, a source follower may be used where noise is not a problem. This may be achieved with a 22 kΩ resistor between source and envelope with the positive supply taken to the drain terminal. This will give a voltage gain of approximately 0.9.

DEFINITIONS

1. N.E.P. (Noise Equivalent Power),  $WHz^{-1/2}$   
This is the r.m.s. value of the incident, chopped, radiant power necessary to produce an r.m.s. signal to r.m.s. noise ratio of unity. The r.m.s. noise refers to the value calculated for unit square root bandwidth  $VHz^{-1/2}$
2. Responsivity,  $VW^{-1}$   
This is the ratio of the r.m.s. signal in volts to the r.m.s. value of the incident, chopped radiant power.



**APPLICATION INFORMATION**

- Optional additional stage for extra gain

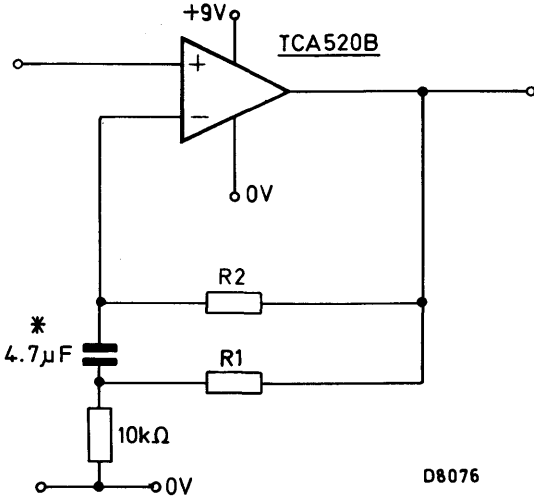

Recommended component values for various gains

Gain x	R <sub>1</sub> kΩ	R <sub>2</sub> MΩ
50	560	5.6
20	220	2.2
10	100	1.0

\*this capacitor must be a low leakage type e.g. our 344 series.

- The pyroelectric element may be considered as a capacitor whose charge state changes with temperature. It also behaves as a normal capacitor, i.e. its voltage changes with charge. Thus a change of temperature results in a change of charge. It can be seen that, for a given change in amplitude of incident radiation, the resulting change in temperature will decrease as the chopping frequency increases. Thus the voltage change will also decrease with frequency. In addition, there is a 90° phase lag between the thermal and electrical signals. The voltage signal therefore becomes the integral of the radiation signal.

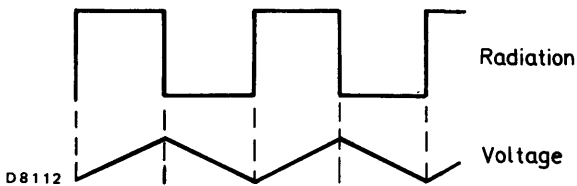



### 3. Temperature slew

The FET used with a pyroelectric detector requires a gate leakage resistor to earth in parallel with the element. This stabilizes its working point. The pyroelectric voltage appearing across this resistor is proportional to the rate of change of temperature.

To ensure a low level of noise current from this resistor, its value should be of the order of  $3 \times 10^{10} \Omega$ .

When the temperature slew rate is  $1^\circ\text{C}/\text{minute}$ , the pyroelectric voltage produced is 1 volt. In a system which is designed to sense microvolts, this is almost certain to cause overload and any a.c. signal superimposed on this d.c. shift will be lost.

Our detectors incorporate a bleed system which acts progressively on the d.c. shift caused by temperature slew. The law is logarithmic.

Thus a slew rate of  $0.1^\circ\text{C}/\text{minute}$  may produce an offset across the sensing element of 200 millivolts,  $1^\circ\text{C}/\text{minute}$  280 millivolts and  $10^\circ\text{C}/\text{minute}$  360 millivolts.

### MECHANICAL AND ENVIRONMENTAL STANDARDS

As part of the Quality Assurance programme, the detectors are assessed at regular intervals against the requirements of the following IEC standards. The frequency of testing and the limits and conditions for the pre- and post-test measurements are based on those stipulated for the CECC 50 000 series of approved transistors.

			note
IEC 68-2-3	Test Ca	Moisture Resistance, steady state	1
68-2-20	Test T	Solderability	1
68-2-21	Test Ub	Lead Fatigue	1
68-2-1	Test A	Low Temperature Storage	2
68-2-2	Test Ba	High Temperature Storage	2
68-2-14	Test Nb	Change of Temperature (10 cycles)	2
68-2-6	Test Fc (B4)	Vibration, swept frequency	2
68-2-7	Test Ga	Acceleration, steady state	2
68-2-27	Test Ea	Shock	2
68-2-20	Test T	Resistance to Solder Heat	3

#### Notes

1. The detectors are checked on a production batch release principle at approximately weekly intervals. This is equivalent to group B.
2. The detectors are checked at quarterly intervals; the storage tests to 2000 hours. This is equivalent to group C.
3. This is an annual check.



RPY88  
RPY89

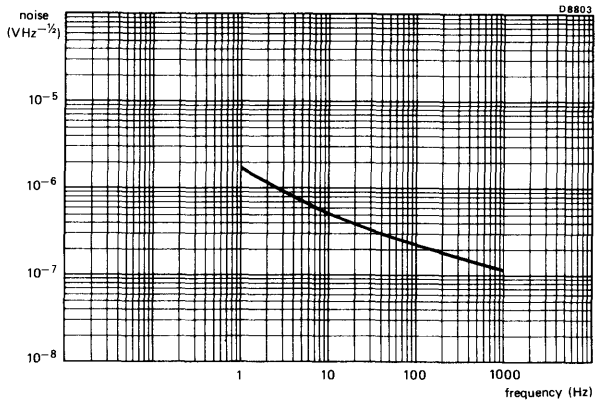
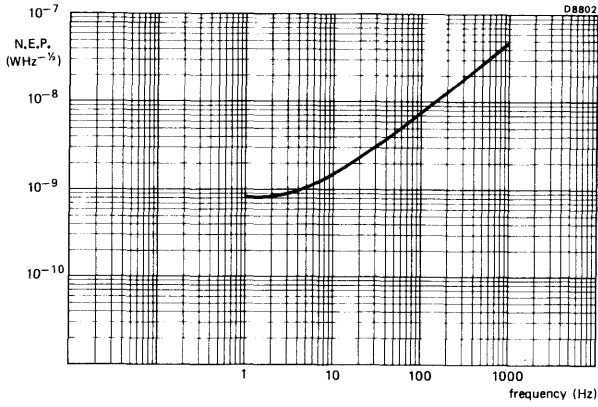
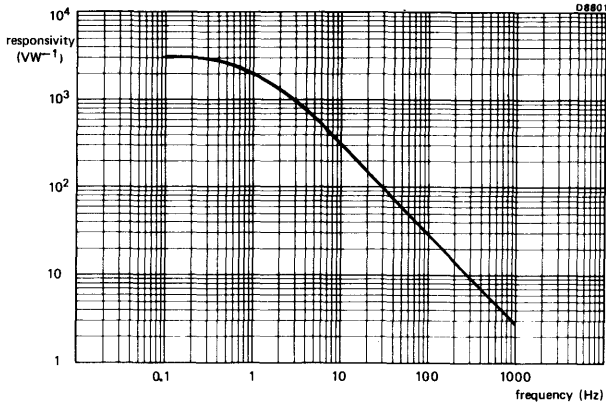

RPY88, typical responsivity, N.E.P., and noise as a function of frequency



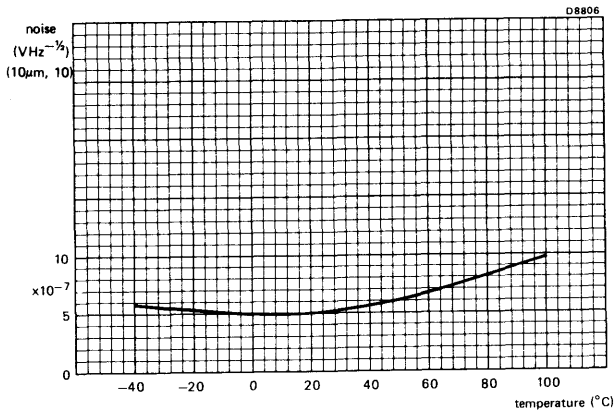
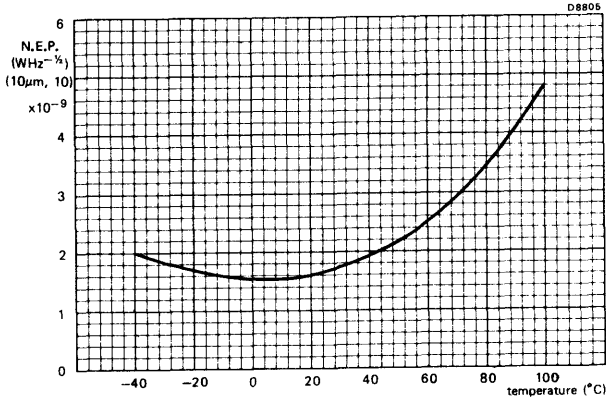
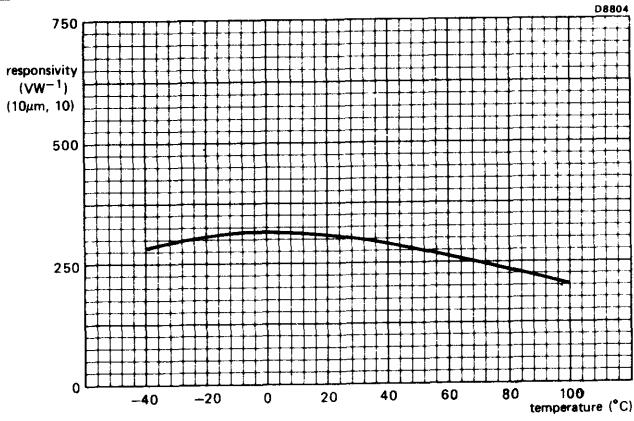

RPY88, typical responsivity, N.E.P., and noise as a function of temperature



RPY88  
RPY89

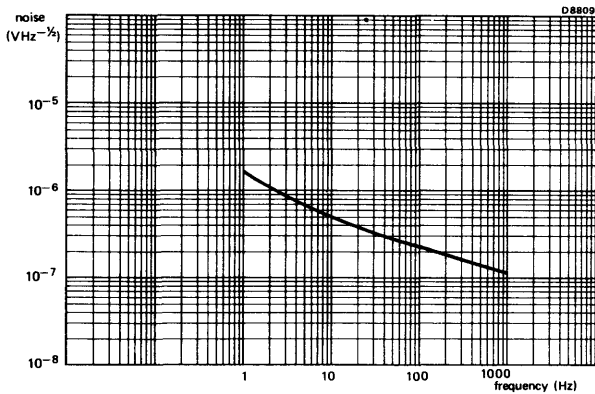
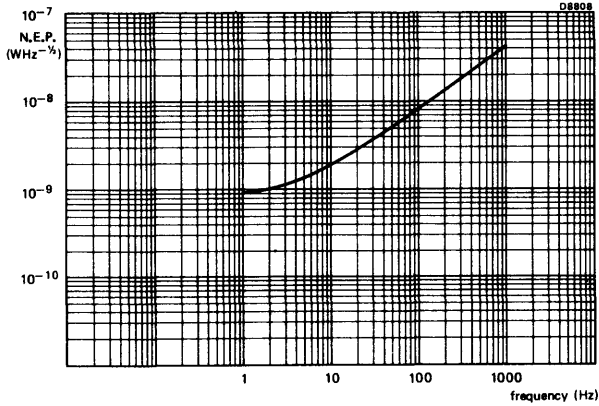
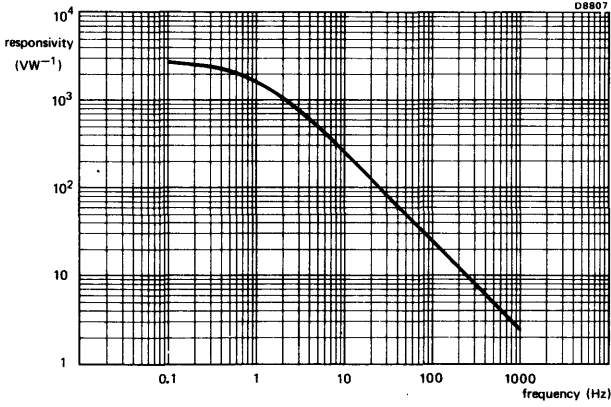

RPY89, typical responsivity, N.E.P., and noise as a function of frequency



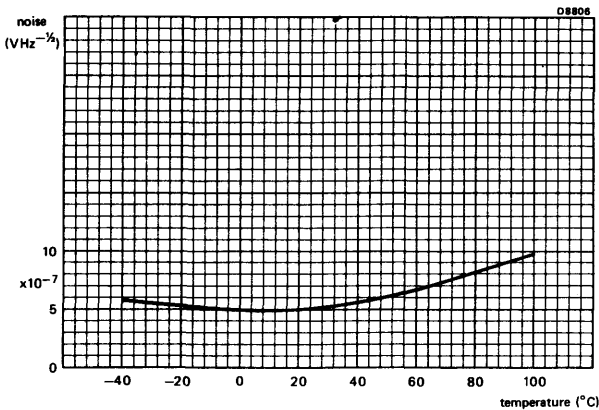
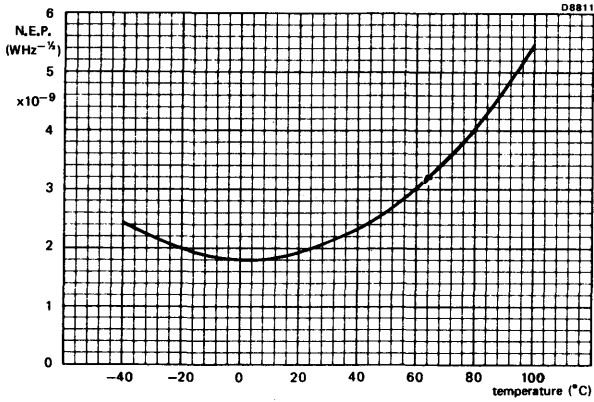
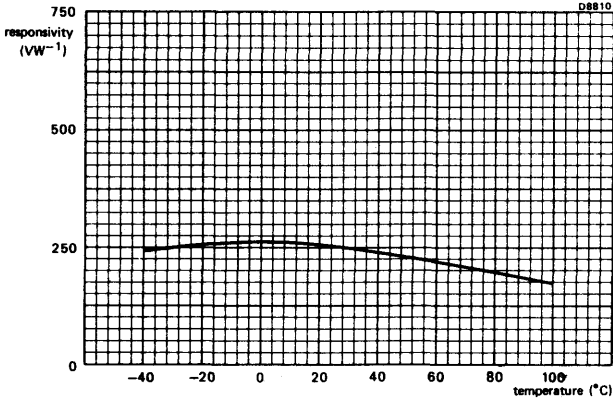

RPY89, typical responsivity, N.E.P., and noise as a function of temperature



RPY88  
RPY89

POLAR DIAGRAMS

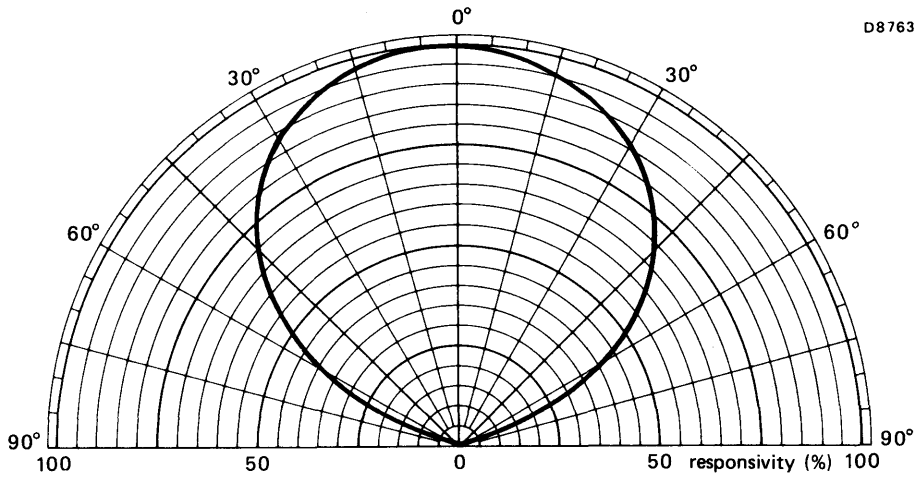

D8763

Typical field of view in x-x plane (see mechanical data)

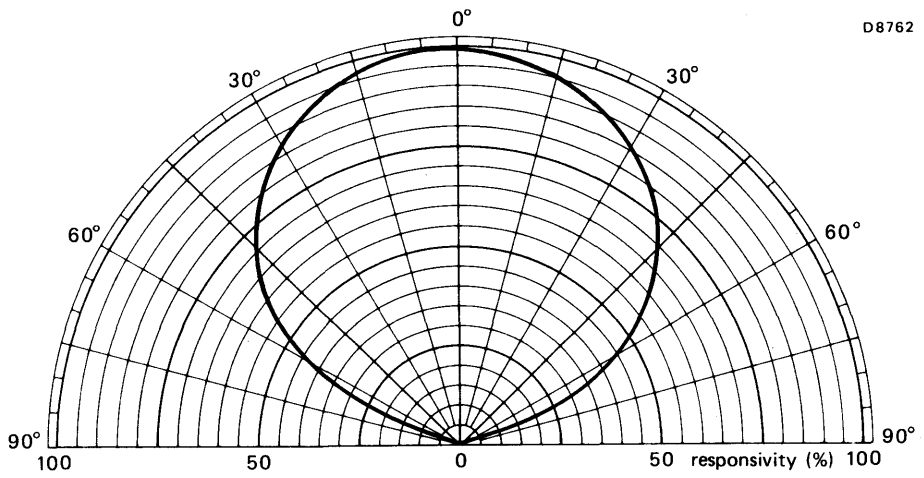

D8762

Typical field of view in y-y plane (see mechanical data)



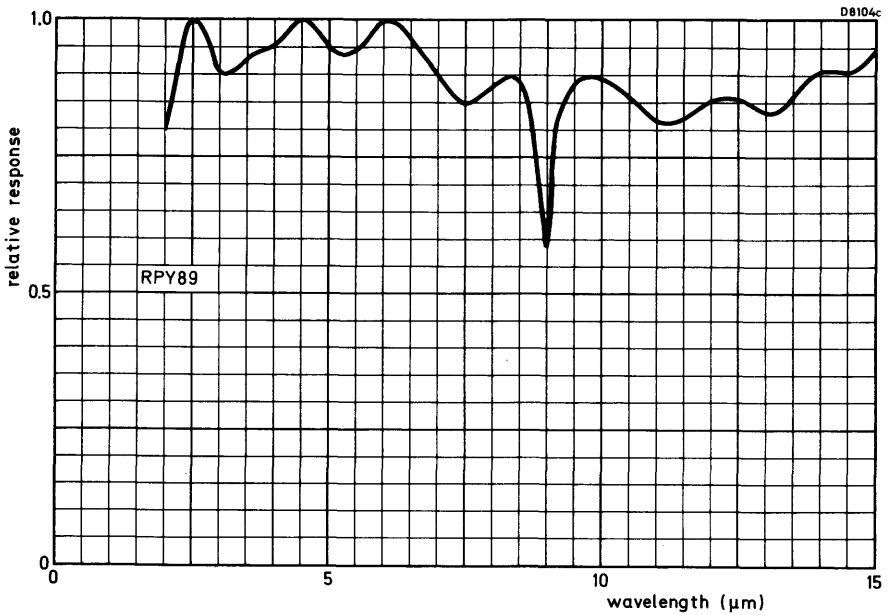
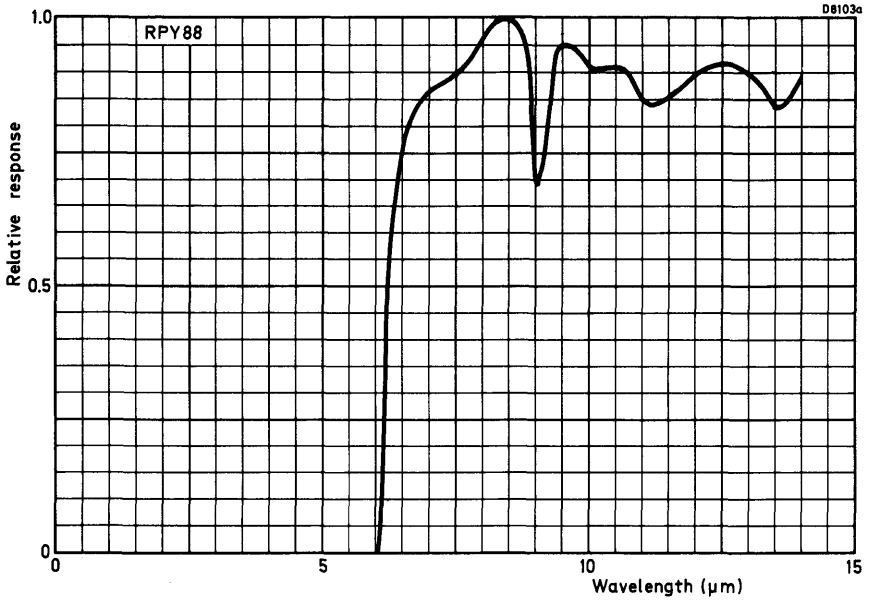

Typical window transmission characteristics







## LATGS PYROELECTRIC INFRARED DETECTORS

This series of pyroelectric infrared detectors is designed to replace conventional bolometers. The sensitive material is L-alanine doped triglycine sulphate\* (LATGS) which operates at room temperature and has a good broadband performance. Each device has a 2.0 x 0.5 mm sensitive area and is available with a selection of window materials giving a range of spectral performance. A pre-amplifier with short circuit protection is incorporated.

### QUICK REFERENCE DATA

	Window material	Spectral response $\mu\text{m}$	Window description
RPY90A	caesium iodide	1 to 70	transparent, hygroscopic, soft
RPY90C	KRS-5	1 to 40	non-hygroscopic, toxic
RPY90D	silicon (AR coated – optimized for 8 to 14 $\mu\text{m}$ use).	1.2 to 15	non-hygroscopic
RPY90E	sapphire	1 to 6.5	transparent, non-hygroscopic
N.E.P.** (500K, 10, 1)	RPY90A	typ. $1.0 \times 10^{-10}$	$\text{WHz}^{-\frac{1}{2}}$
Responsivity (500K, 10)		typ. $8.0 \times 10^3$	$\text{VW}^{-1}$
Recommended operating voltage		9	V
Operating frequency range		10 to 1000	Hz
Optimum operating temperature range		-20 to +45	$^{\circ}\text{C}$
Field of view		> 60	degrees

This data must be read in conjunction with GENERAL SAFETY RECOMMENDATIONS – OPTOELECTRONIC DEVICES

### PRODUCT SAFETY

Modern high technology materials have been used in the manufacture of this device to ensure high performance. Some of these materials are toxic in certain circumstances. Mechanical or electrical damage is unlikely to give rise to any hazard, but toxic vapours may be generated if the device is heated to destruction. Disposal of large quantities should therefore be carried out in accordance with the Deposit of Poisonous Waste Act 1972 and the Control of Pollution Act 1974, or with the latest legislation.

\* LATGS cuts off below  $\lambda = 1 \mu\text{m}$ , where incident energy is no longer absorbed.

\*\* Noise Equivalent Power



MECHANICAL DATA

Dimensions in mm

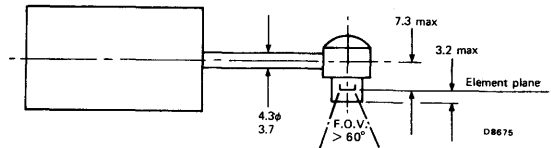
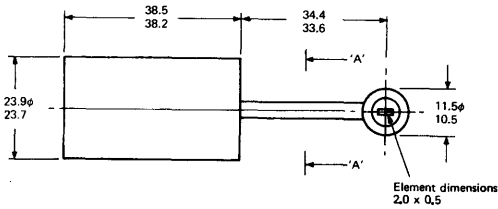
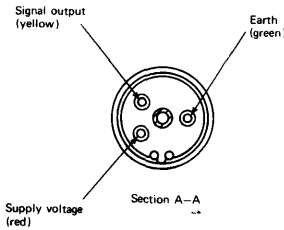

Three female connectors are supplied with each device to fit Sealectro feed throughs type no. FT SM 14.

RATINGS

Limiting values in accordance with the Absolute Maximum System (IEC134)

Supply voltage	max.	+18	V
Supply current	max.	10	mA
Ambient operating temperature		-20 to +45	°C
Storage temperature		-20 to +55	°C

CHARACTERISTICS at  $T_{amb} = 20\text{ }^{\circ}\text{C}$ , using a 500 K black body source

		RPY90A	C	D	E	
N.E.P. (500 K, 10, 1)	typ.	1.0	1.3	1.6	3.0	$\times 10^{-10}$ $\text{WHz}^{-\frac{1}{2}}$
	<	1.5	2.0	2.4	4.5	$\times 10^{-10}$ $\text{WHz}^{-\frac{1}{2}}$
Responsivity (500 K, 10)*	typ.	8.0	6.2	5.0	2.7	$\times 10^3$ $\text{VW}^{-1}$
Noise per unit bandwidth at 10 Hz	typ.	0.8	0.8	0.8	0.8	$\mu\text{VHz}^{-\frac{1}{2}}$
Output voltage (d.c.level)	>	2	2	2	2	V
	typ.	3	3	3	3	V
	<	8	8	8	8	V
Output impedance	<	4	4	4	4	k $\Omega$
Element dimensions		all types: 2.0 x 0.5				mm
Field of view		all types: > 60				degrees
Operating voltage range		all types: 8 to 10				V
Supply current		all types: up to 10				mA

\*These detectors can also be supplied with an integral frequency compensated amplifier similar to that described under Application Information. This would, for example, increase the responsivity by up to x 100 with an amplifier designed to give a flat response to 20 Hz.



**OPERATING NOTES**

1. The detector is supplied with a black plastic cap to protect the window. This cap must be removed before operation.
2. The shape of the electrical output waveform is the integral of the incident radiation waveform.
3. It is inadvisable to operate the detector at mains related frequencies.
4. To avoid the possibility of optical microphony, the detector must be firmly mounted.
5. An increase in temperature of the element will produce a negative going signal at the output.
6. Provided that the operating voltage does not exceed 10 V, the maximum time for the output to be short-circuited (to the supply or common rail) is unlimited.

**DEFINITIONS**

1. N.E.P. (Noise Equivalent Power),  $\text{WHz}^{-1/2}$   
This is the r.m.s. value of the incident, chopped, radiant power necessary to produce an r.m.s. signal to r.m.s. noise ratio of unity. The r.m.s. noise refers to the value calculated for unit square root bandwidth  $\text{VHz}^{-1/2}$ .
2. Responsivity  $\text{VW}^{-1}$   
This is the ratio of the r.m.s. signal in volts to the r.m.s. value of the incident, chopped, radiant power.



**APPLICATION INFORMATION**

1. The pyroelectric element may be considered as a capacitor whose charge state changes with temperature. It also behaves as a normal capacitor, i.e. its voltage changes with charge. Thus a change of temperature results in a change of voltage. It can be seen that, for a given change in amplitude of incident radiation, the resulting change in temperature will decrease as the chopping frequency increases. Thus the voltage change will also decrease with frequency. In addition, there is a 90° phase lag between the thermal and electrical signals. The voltage signal therefore becomes the integral of the radiation signal.

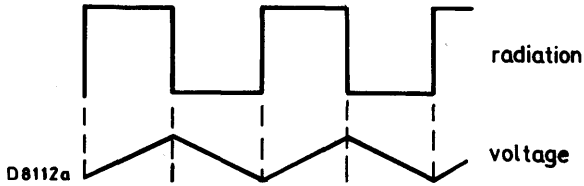

2. Frequency compensating amplifier

The following circuit is designed to be connected directly to the detector output and may be used to compensate for the falling responsivity characteristic with frequency. It is a simple 'virtual earth' amplifier which uses a series input capacitor to provide increasing current through the feedback resistor  $R_2$  with increasing frequency. The time constants  $R_2 C_2$  and  $R_3 C_3$  are chosen to coincide with  $R_1 C_1$ , where  $R_1$  is the output impedance of the detector ( $< 4.0 \text{ k}\Omega$ ).

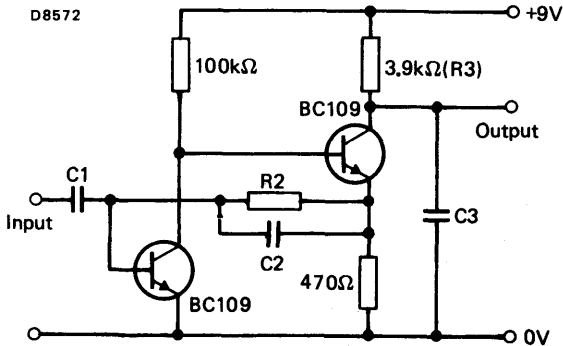

The table below gives recommended component values for various roll-off frequencies (approx. -3 dB point).

Frequency Hz	$C_1 C_3$ nF	$R_2$ kΩ	$C_2$ nF
30	680	330	10
300	68	220	1.5
600	33	330	0.47
1500	15	68	1.0
3000	15	82	0.47
4500	4.7	68	0.33

With this circuit the original shape of the radiation waveform is restored at the output for chopping frequencies sensibly lower than the roll-off frequency.



3. Additional stage for extra gain which may be connected directly to the detector output or to the output of the frequency compensating amplifier.

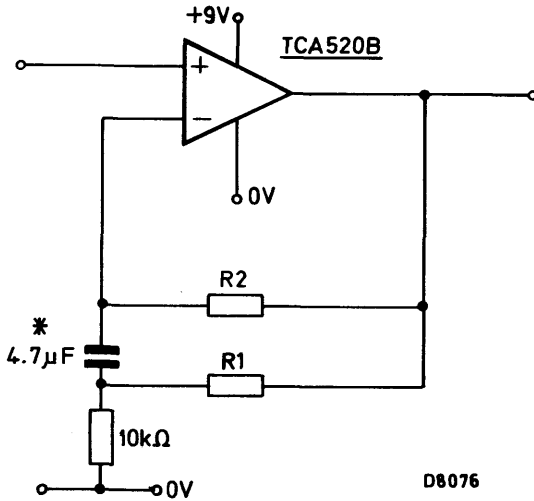

Recommended component values for various gains

Gain x	R <sub>1</sub> kΩ	R <sub>2</sub> MΩ
50	560	5.6
20	220	2.2
10	100	1.0

\*this capacitor must be a low leakage type, e.g. our 344 series

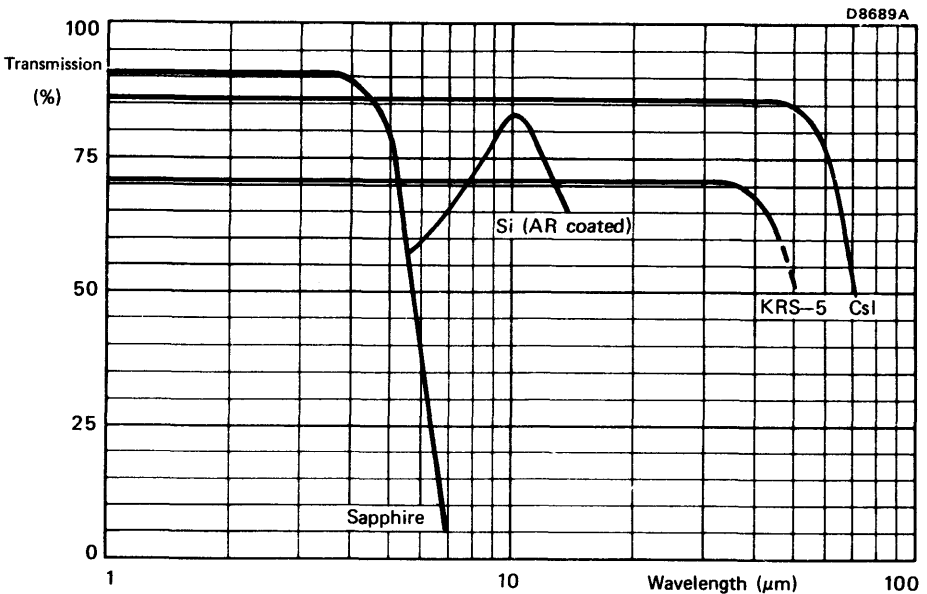

Typical window transmission characteristics.



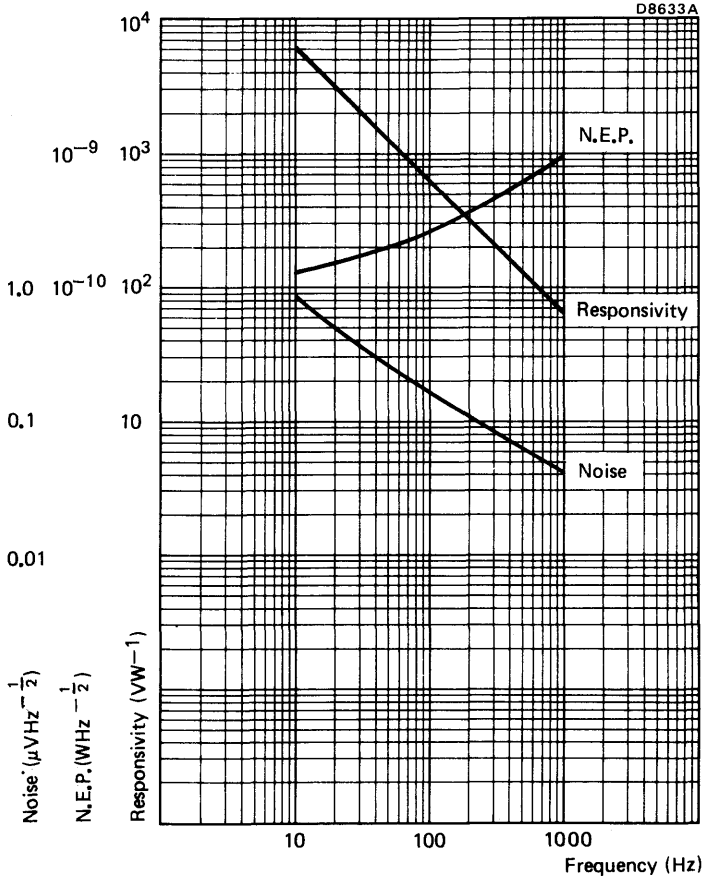

RPY90A

Typical 500 K black body performance as a function of frequency



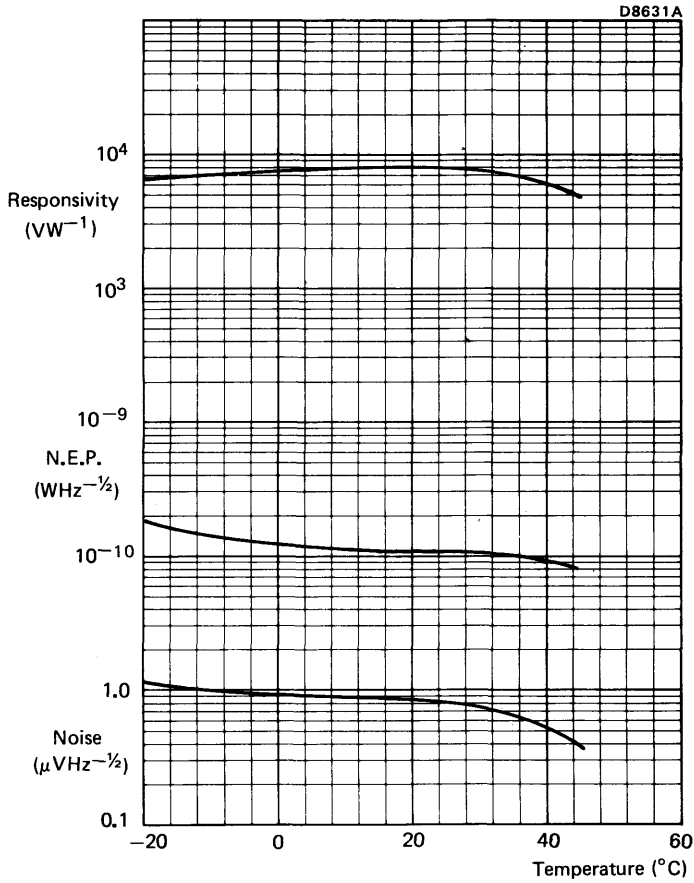

RPY90A

Typical 500 K black body performance as a function of temperature



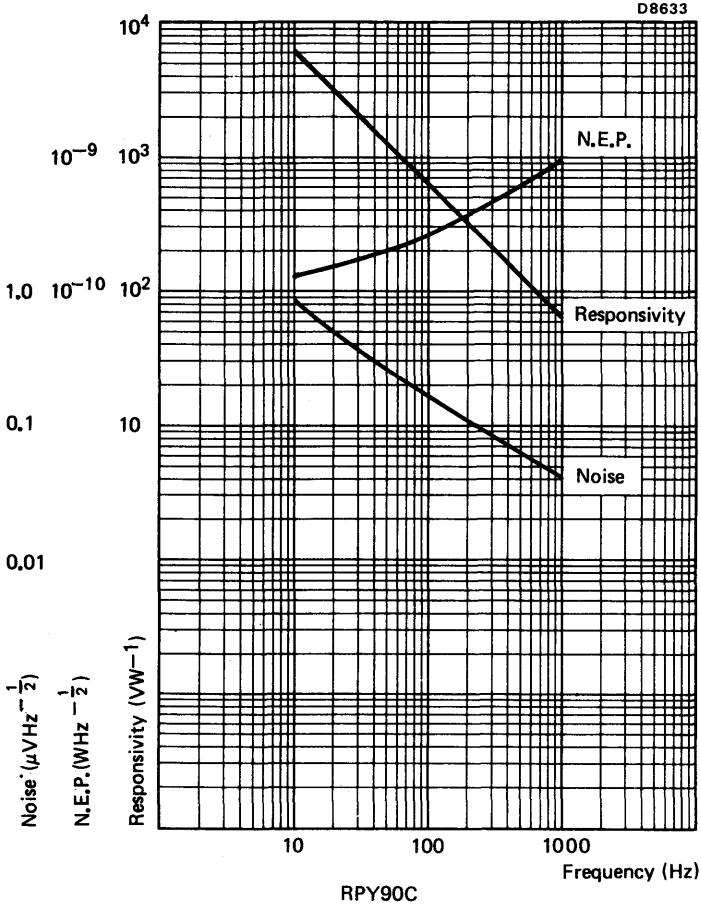

Typical 500 K black body performance as a function of frequency





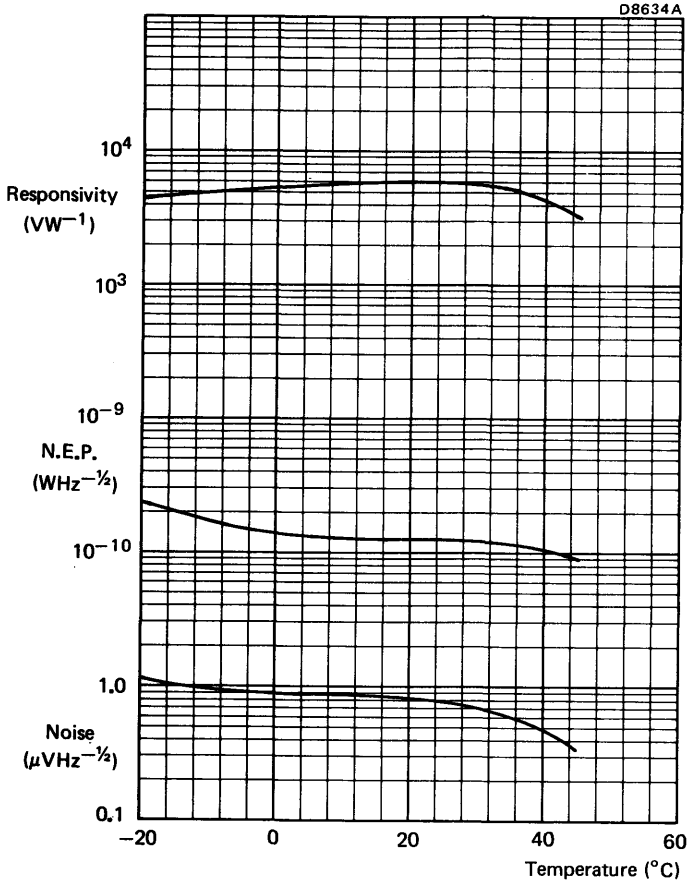

RPY90C

Typical 500 K black body performance as a function of temperature



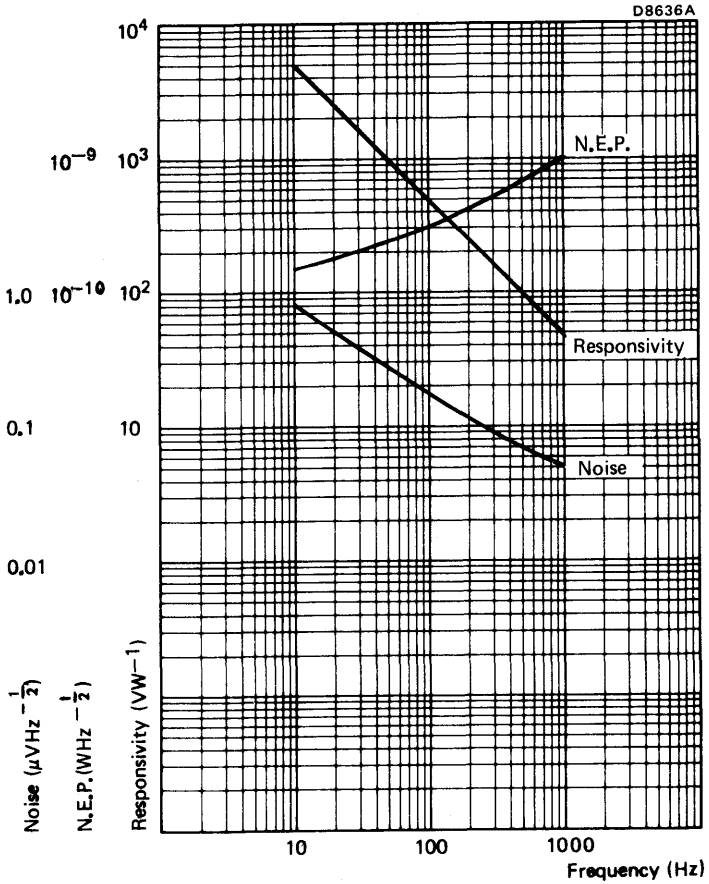

RPY90D

Typical 500 K black body performance as a function of frequency



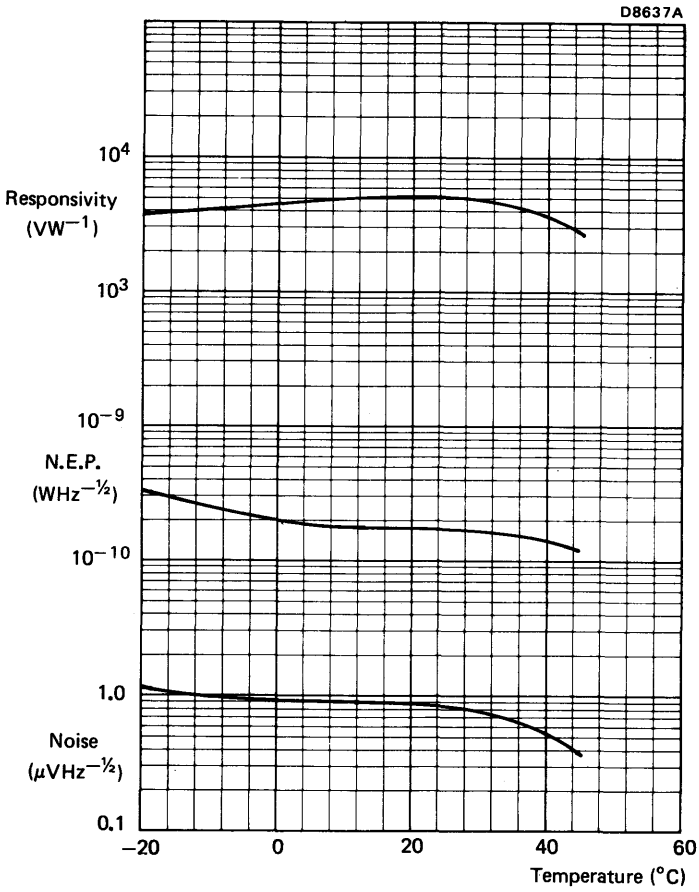

RPY90D

Typical 500 K black body performance as a function of temperature



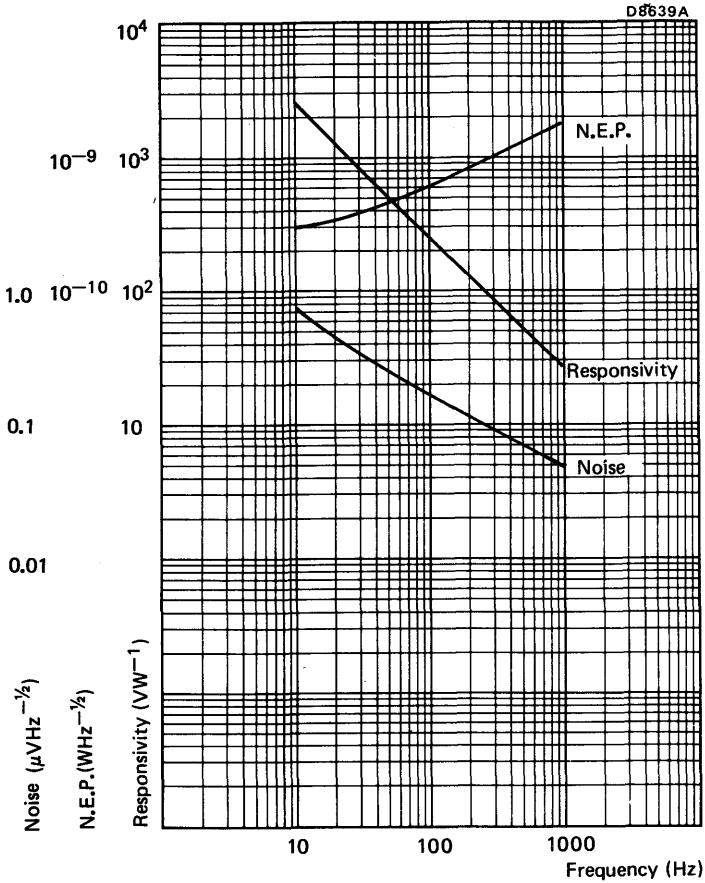

RPY90E

Typical 500 K black body performance as a function of frequency



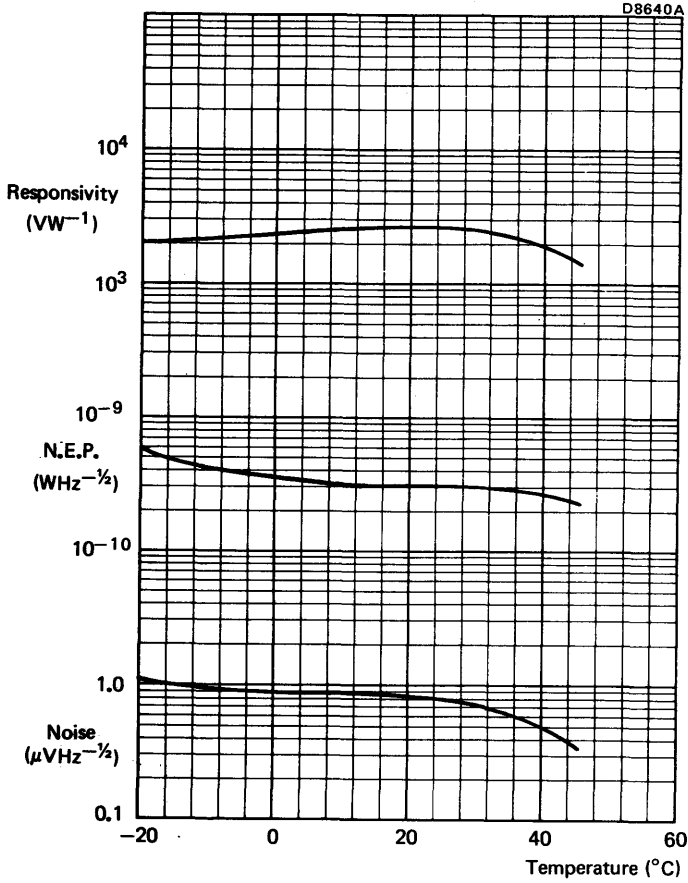

RPY90E

Typical 500K black body performance as a function of temperature





## LATGS PYROELECTRIC INFRARED DETECTORS

This series of pyroelectric infrared detectors is designed to replace conventional bolometers. The sensitive material is L-alanine doped triglycine sulphate\* (LATGS) which operates at room temperature and has a good broadband performance. Each device has a 2.75 x 1.25 mm sensitive area and is available with a selection of window materials giving a range of spectral performance. A pre-amplifier with short circuit protection is incorporated.

### QUICK REFERENCE DATA

	Window material	Spectral response $\mu\text{m}$	Window description
RPY91A	caesium iodide	1 to 70	transparent, hygroscopic, soft
RPY91C	KRS-5	1 to 40	non-hygroscopic, toxic
RPY91D	silicon (AR coated—optimized for 8 to 14 $\mu\text{m}$ use).	1.2 to 15	non-hygroscopic
RPY91E	sapphire	1 to 6.5	transparent, non-hygroscopic
N.E.P.** (500K, 10, 1)	RPY91A	typ. $1.5 \times 10^{-10}$	$\text{WHz}^{-1/2}$
Responsivity (500K, 10)		typ. $6.5 \times 10^3$	$\text{VW}^{-1}$
Recommended operating voltage		9	V
Operating frequency range		10 to 1000	Hz
Optimum operating temperature range		-20 to +45	$^{\circ}\text{C}$
Field of view		> 60	degrees

This data must be read in conjunction with GENERAL SAFETY RECOMMENDATIONS – OPTOELECTRONIC DEVICES

### PRODUCT SAFETY

Modern high technology materials have been used in the manufacture of this device to ensure high performance. Some of these materials are toxic in certain circumstances. Mechanical or electrical damage is unlikely to give rise to any hazard, but toxic vapours may be generated if the device is heated to destruction. Disposal of large quantities should therefore be carried out in accordance with the Deposit of Poisonous Waste Act 1972 and the Control of Pollution Act 1974, or with the latest legislation.

\* LATGS cuts off below  $\lambda = 1 \mu\text{m}$ , where incident energy is no longer absorbed.

\*\* Noise Equivalent Power



MECHANICAL DATA

Dimensions in mm

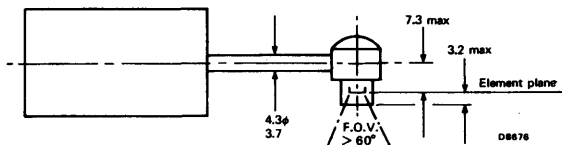
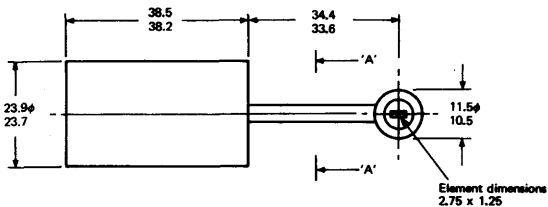
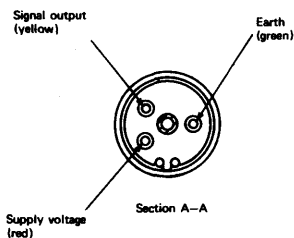

Three female connectors are supplied with each device to fit Sealectro feed throughs type no. FT SM 14.

RATINGS

Limiting values in accordance with the Absolute Maximum System (IEC134)

Supply voltage	max.	+18	V
Supply current	max.	10	mA
Ambient operating temperature		-20 to +45	°C
Storage temperature		-20 to +55	°C

CHARACTERISTICS at  $T_{amb} = 20\text{ }^{\circ}\text{C}$ , using a 500 K black body source

		RPY91A	C	D	E	
N.E.P. (500 K, 10, 1)	typ.	1.5	2.0	2.5	$4.5 \times 10^{-10}$	$\text{WHz}^{-1/2}$
	<	3.0	4.0	5.0	$9.0 \times 10^{-10}$	$\text{WHz}^{-1/2}$
Responsivity (500 K, 10)*	typ.	6.5	5.0	4.0	$2.3 \times 10^3$	$\text{VW}^{-1}$
Noise per unit bandwidth at 10 Hz	typ.	1.0	1.0	1.0	1.0	$\mu\text{VHz}^{-1/2}$
Output voltage (d.c. level)	>	4	4	4	4	V
	typ.	6	6	6	6	V
	<	8	8	8	8	V
	<	4	4	4	4	k $\Omega$
Element dimensions		all types: 2.75 x 1.25				mm
Field of view		all types: > 60				degrees
Operating voltage range		all types: 8 to 10				V
Supply current		all types: up to 10				mA

\*These detectors can also be supplied with an integral frequency compensated amplifier similar to that described under Application Information. This would, for example, increase the responsivity by up to x 100 with an amplifier designed to give a flat response to 20 Hz.





**OPERATING NOTES**

1. The detector is supplied with a black plastic cap to protect the window. This cap must be removed before operation
2. The shape of the electrical output waveform is the integral of the incident radiation waveform.
3. It is inadvisable to operate the detector at mains related frequencies.
4. To avoid the possibility of optical microphony, the detector must be firmly mounted.
5. An increase in temperature of the element will produce a negative going signal at the output.
6. Provided that the operating voltage does not exceed 10 V, the maximum time for the output to be short-circuited (to the supply or common rail) is unlimited.

**DEFINITIONS**

1. N.E.P. (Noise Equivalent Power)  $WHz^{-1/2}$   
This is the r.m.s. value of the incident, chopped, radiant power necessary to produce an r.m.s. signal to r.m.s. noise ratio of unity. The r.m.s. noise refers to the value calculated for unit square root bandwidth  $VHz^{-1/2}$ .
2. Responsivity  $VW^{-1}$   
This is the ratio of the r.m.s. signal in volts to the r.m.s. value of the incident, chopped, radiant power.



**APPLICATION INFORMATION**

- The pyroelectric element may be considered as a capacitor whose charge state changes with temperature. It also behaves as a normal capacitor, i.e. its voltage changes with charge. Thus a change of temperature results in a change of voltage. It can be seen that, for a given change in amplitude of incident radiation, the resulting change in temperature will decrease as the chopping frequency increases. Thus the voltage change will also decrease with frequency. In addition, there is a 90° phase lag between the thermal and electrical signals. The voltage signal therefore becomes the integral of the radiation signal.

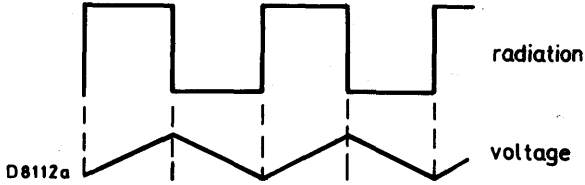

- Frequency compensating amplifier

The following circuit is designed to be connected directly to the detector output and may be used to compensate for the falling responsivity characteristic with frequency. It is a simple 'virtual earth' amplifier which uses a series input capacitor to provide increasing current through the feedback resistor  $R_2$  with increasing frequency. The time constants  $R_2 C_2$  and  $R_3 C_3$  are chosen to coincide with  $R_1 C_1$ , where  $R_1$  is the output impedance of the detector ( $< 4.0 \text{ k}\Omega$ ).

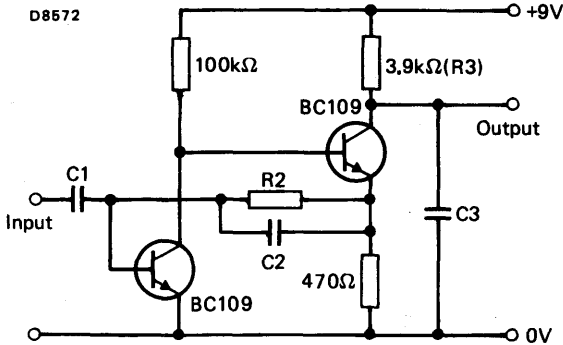

The table below gives recommended component values for various roll-off frequencies (approx. -3 dB point).

Frequency Hz	$C_1 C_3$ nF	$R_2$ kΩ	$C_2$ nF
30	680	330	10
300	68	220	1.5
600	33	330	0.47
1500	15	68	1.0
3000	15	82	0.47
4500	4.7	68	0.33

With this circuit the original shape of the radiation waveform is restored at the output for chopping frequencies sensibly lower than the roll-off frequency.



3. Additional stage for extra gain which may be connected directly to the detector output or to the output of the frequency compensating amplifier.

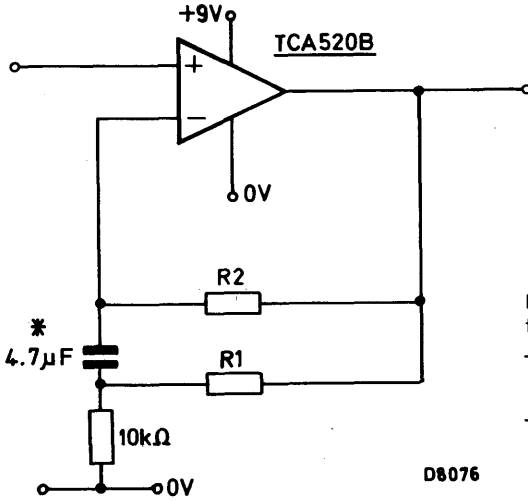

Recommended component values for various gains

Gain x	R <sub>1</sub> kΩ	R <sub>2</sub> MΩ
50	560	5.6
20	220	2.2
10	100	1.0

\*this capacitor must be a low leakage type, e.g. our 344 series

D8076

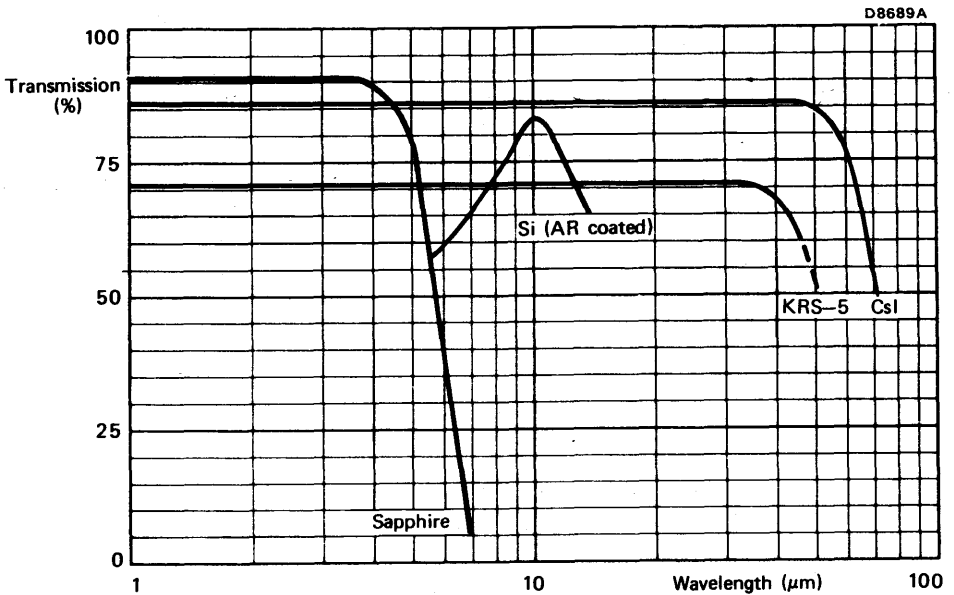

D8689A

Typical window transmission characteristics.



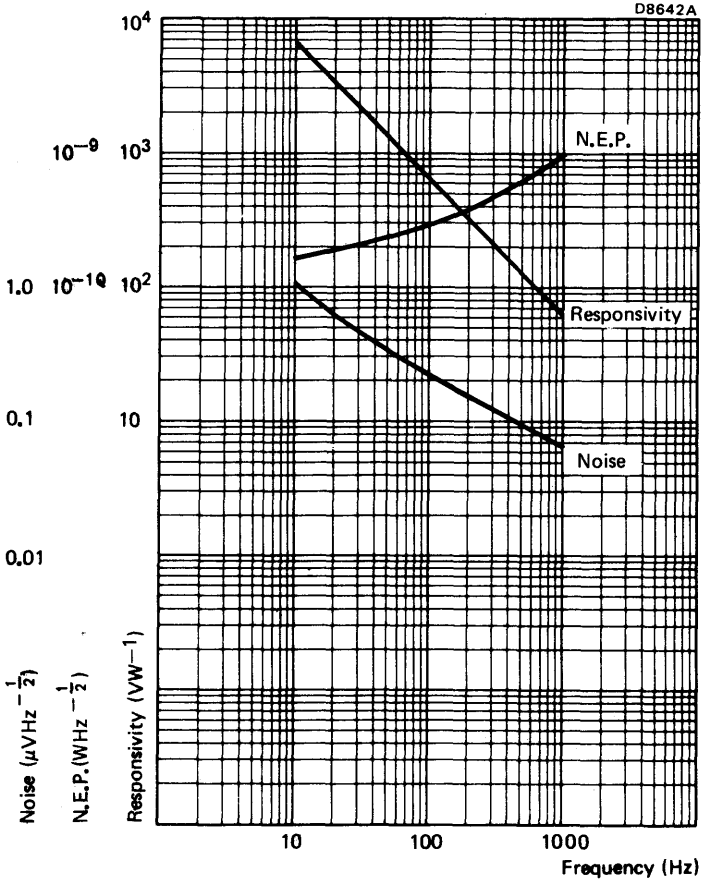

RPY91A

Typical 500K black body performance as a function of frequency



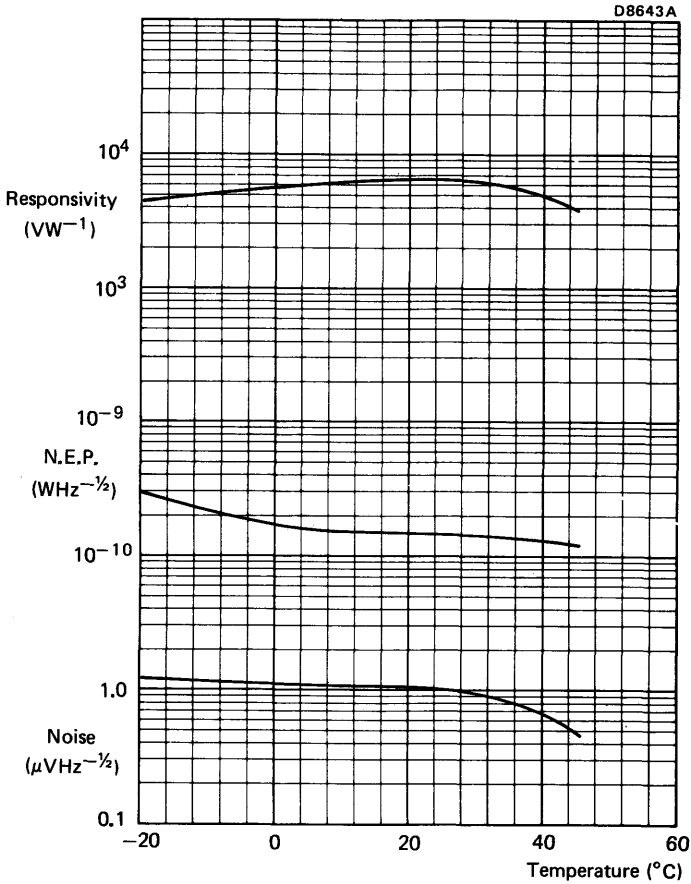

RPY91A

Typical 500K black body performance as a function of temperature



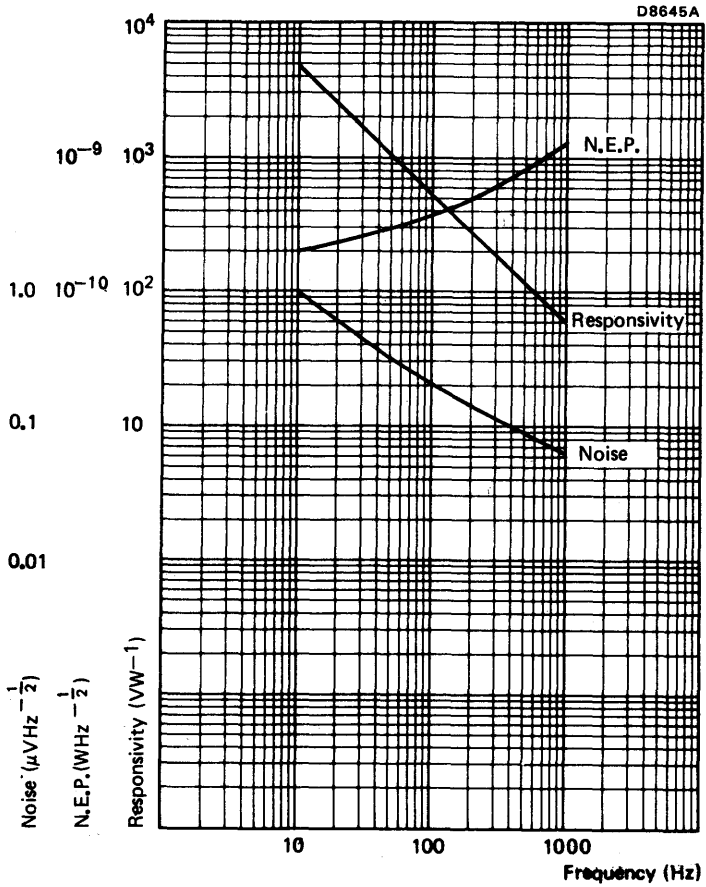

RPY91C

Typical 500K black body performance as a function of frequency



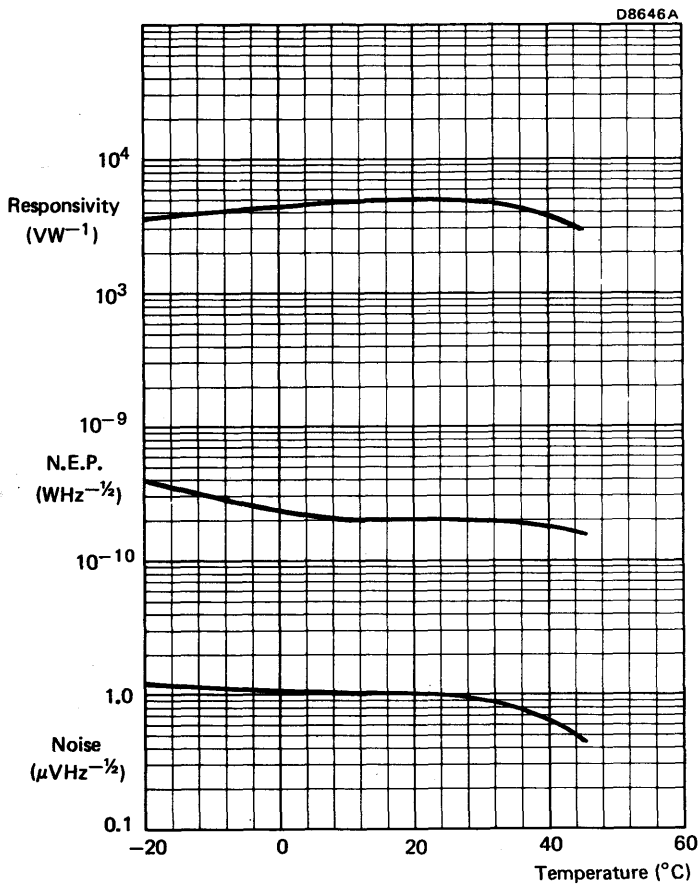

RPY91C

Typical 500K black body performance as a function of temperature



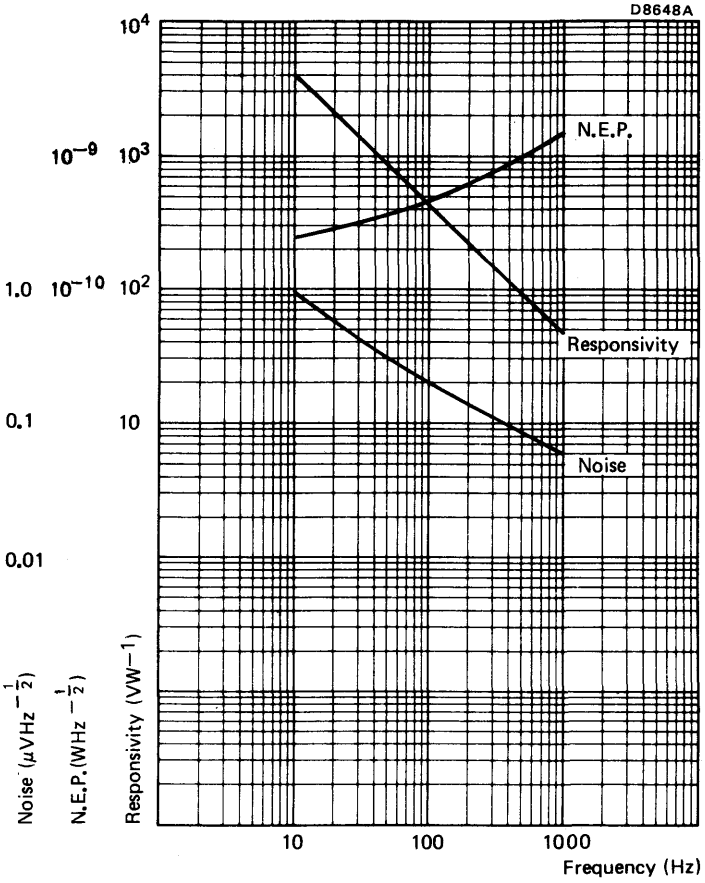

RPY91D

Typical 500K black body performance as a function of frequency





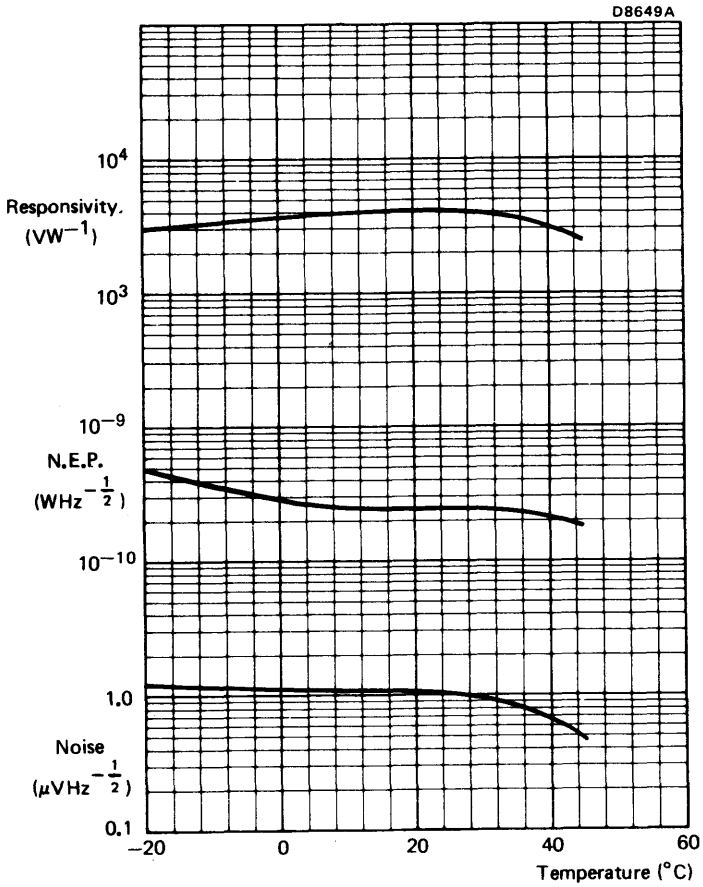

RPY91D

Typical 500K black body performance as a function of temperature



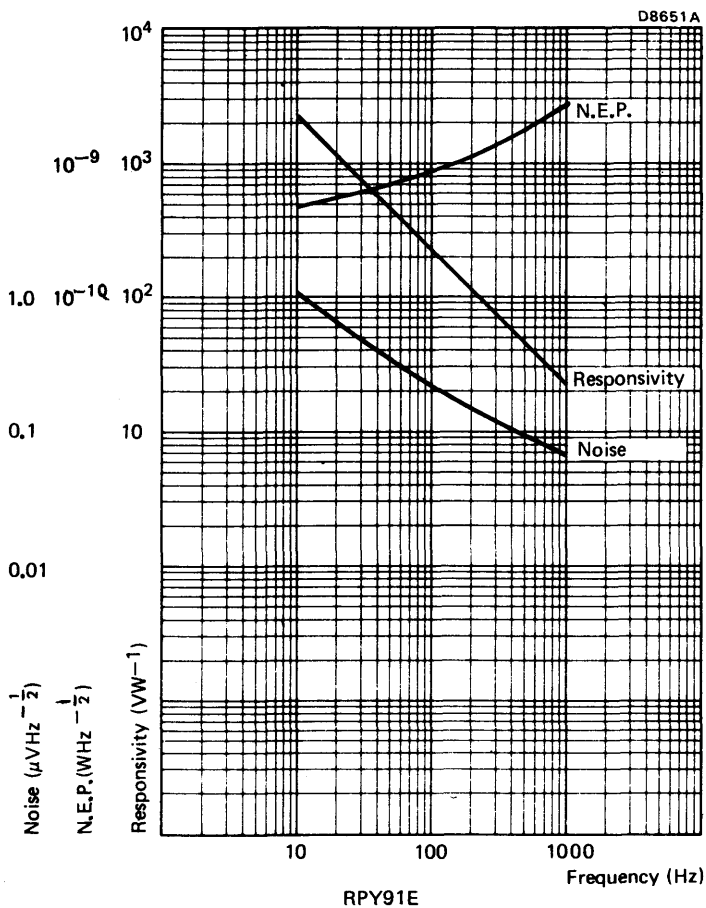

Typical 500K black body performance as a function of frequency



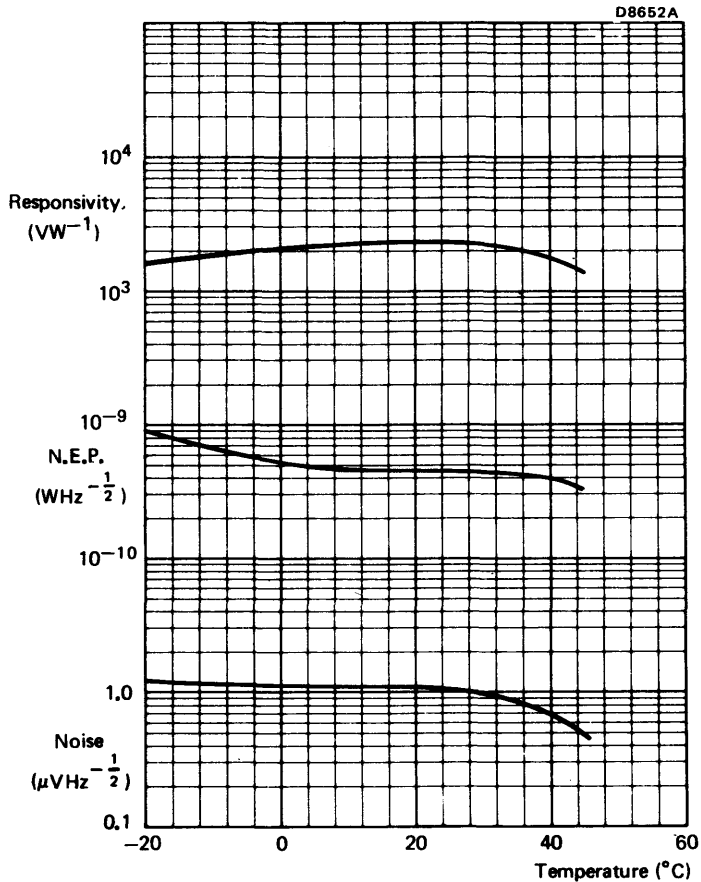

RPY91E

Typical 500K black body performance as a function of temperature





## PYROELECTRIC INFRARED DETECTOR

This is an infrared sensitive device specifically designed for passive IR intruder alarms. It has differentially connected dual elements combined with a single impedance converting amplifier to provide immunity from common mode signals such as those generated by variations in ambient temperature, background radiation and acoustic noise.

The detector will give an output signal only when the radiation falling on the elements is unbalanced, as in a focused system.

It is sealed in a low profile TO-5 can with a window optically coated to restrict the response to wavelengths greater than 6.5  $\mu\text{m}$ .

### QUICK REFERENCE DATA

Spectral response		$6.5 \pm 0.5$ to $> 14$	$\mu\text{m}$
Responsivity (10 $\mu\text{m}$ , 10), each element	typ.	800	$\text{VW}^{-1}$
Noise Equivalent Power (N.E.P.), (10 $\mu\text{m}$ , 10, 1), each element	typ.	$1.4 \times 10^{-9}$	$\text{WHz}^{-\frac{1}{2}}$
Element dimensions, each element		$2 \times 0.75$	mm
Element separation		0.5	mm
Field of view	typ.	112	degrees
Operating voltage		9	V
Optimum operating frequency range		0.1 to 1000	Hz

This data must be read in conjunction with GENERAL SAFETY RECOMMENDATIONS – OPTOELECTRONIC DEVICES

### MECHANICAL DATA

Dimensions in mm

#### SOT-49E (low profile TO-5)

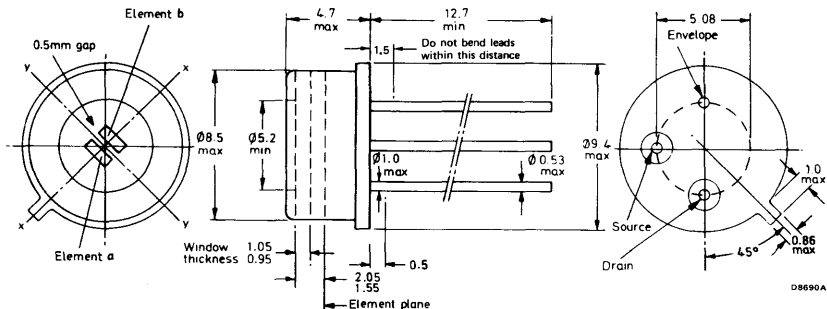

### PRODUCT SAFETY

Modern high technology materials have been used in the manufacture of this device to ensure high performance. Some of these materials are toxic in certain circumstances. Mechanical or electrical damage is unlikely to give rise to any hazard, but toxic vapours may be generated if the device is heated to destruction. Disposal of large quantities should therefore be carried out in accordance with the Deposit of Poisonous Waste Act 1972 and the Control of Pollution Act 1974, or with the latest legislation.



**RATINGS**

Limiting values in accordance with the Absolute Maximum System (IEC134)

Supply voltage	max.	30	V
Temperature, operation	max.	+50	°C
	min.	-40	°C
Temperature, storage	max.	+70	°C
	min.	-40	°C

**SOLDERING**

1. When making soldered connections to the leads, a thermal shunt must be used.
2. It is essential that any mains operated soldering iron used should be both screened and earthed. Failure to observe these precautions may lead to the introduction of line voltage and possible damage to the device.

**CHARACTERISTICS** (at  $T_{amb} = 25 \pm 3$  °C and with the recommended test circuit)

	min.	typ.	max.	
N.E.P. (10 $\mu$ m, 10, 1) notes 1 and 5	—	$1.4 \times 10^{-9}$	$3 \times 10^{-9}$	WHz <sup>-1/2</sup>
Responsivity (10 $\mu$ m, 10) notes 1 and 5	565	800	—	VW <sup>-1</sup>
Element matching $\frac{(R_a - R_b)}{(R_a + R_b)} \times 100$ note 2	—	$\pm 2$	$\pm 10$	%
Spectral response	$6.5 \pm 0.5$	—	> 14	$\mu$ m
Field of view note 3	—	112	—	degrees
Operating voltage note 4	8	9	10	V

**Notes**

1. Each element. These characteristics apply throughout the spectral response range.
2. Where  $R_a$  and  $R_b$  are the responsivities of the respective elements.
3. Field of view to 50% of the maximum responsivity level.
4. The detector will operate outside the quoted range but may have a degraded performance.
5. For performance as a function of frequency and temperature see pages 6 and 7.

**TEST CIRCUIT**

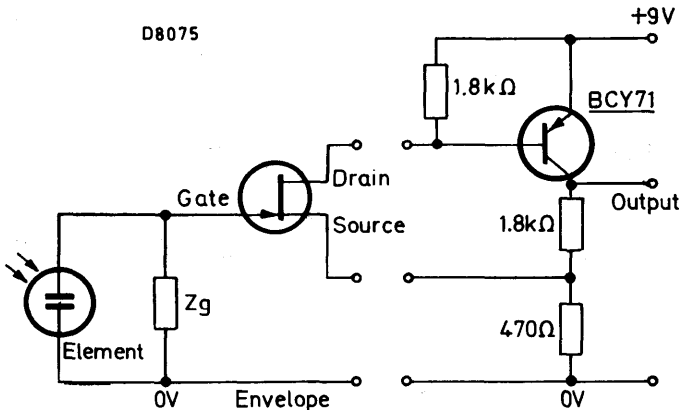

**OPERATING NOTES**

1. The detector may be supplied with a black plastic cap to protect the window. This cap must be removed before operation.
2. The case potential must not be allowed to become positive with respect to the other two terminals.
3. The shape of the electrical output waveform for each element is the integral of the incident radiation waveform.
4. It is inadvisable to operate the detector at mains related frequencies.
5. To avoid the possibility of optical microphony, the detector must be firmly mounted.
6. Use the recommended circuit for low noise operation.
7. An increase in temperature of element a will produce a negative going signal at the output. For element b, the corresponding output will be positive going.
8. For simplicity of operation, a source follower may be used where noise is not a problem. This may be achieved with a  $22\text{ k}\Omega$  resistor between source and envelope with the positive supply taken to the drain terminal. This will give a voltage gain of approximately 0.9.

**DEFINITIONS**

1. N.E.P. (Noise Equivalent Power),  $\text{WHz}^{-\frac{1}{2}}$   
This is the r.m.s. value of the incident, chopped, radiant power necessary to produce an r.m.s. signal to r.m.s. noise ratio of unity. The r.m.s. noise refers to the value calculated for unit square root bandwidth  $\text{VHz}^{-\frac{1}{2}}$ .
2. Responsivity,  $\text{VW}^{-1}$   
This is the ratio of the r.m.s. signal in volts to the r.m.s. value of the incident, chopped, radiant power.



**APPLICATION INFORMATION**

1. Optional additional stage for extra gain.

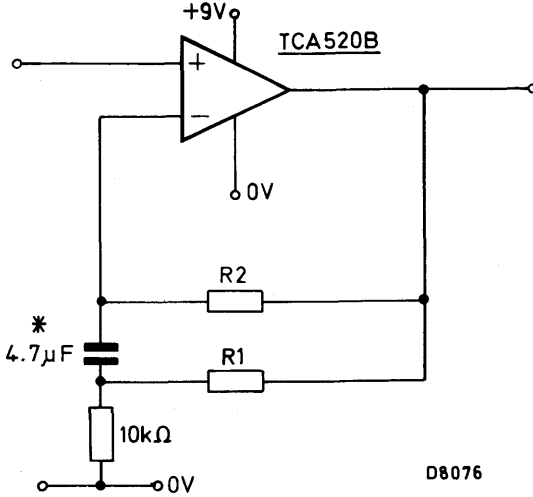

Recommended component values for various gains

Gain x	R <sub>1</sub> kΩ	R <sub>2</sub> MΩ
50	560	5.6
20	220	2.2
10	100	1.0

D8076

\* this capacitor must be a low leakage type e.g. our 344 series.

2. The pyroelectric element may be considered as a capacitor whose charge state changes with temperature. It also behaves as a normal capacitor, i.e. its voltage changes with charge. Thus a change of temperature results in a change of charge. It can be seen that, for a given change in amplitude of incident radiation, the resulting change in temperature will decrease as the chopping frequency increases. Thus the voltage change will also decrease with frequency. In addition, there is a 90° phase lag between the thermal and electrical signals. The voltage signal therefore becomes the integral of the radiation signal.

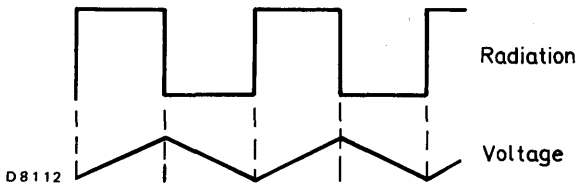

D8112





**MECHANICAL AND ENVIRONMENTAL STANDARDS**

As part of the Quality Assurance programme, the detectors are assessed at regular intervals against the requirements of the following IEC standards. The frequency of testing and the limits and conditions for the pre- and post-test measurements are based on those stipulated for the CECC 50 000 series of approved transistors.

			note
IEC 68-2-3	Test Ca	Moisture Resistance, steady state	1
68-2-20	Test T	Solderability	1
68-2-21	Test Ub	Lead Fatigue	1
68-2-1	Test A	Low Temperature Storage	2
68-2-2	Test Ba	High Temperature Storage	2
68-2-14	Test Nb	Change of Temperature (10 cycles)	2
68-2-6	Test Fc (B4)	Vibration, swept frequency	2
68-2-7	Test Ga	Acceleration, steady state	2
68-2-27	Test Ea	Shock	2
68-2-20	Test T	Resistance to Solder Heat	3

**Notes**

1. The detectors are checked on a production batch release principle at approximately weekly intervals. This is equivalent to group B.
2. The detectors are checked at quarterly intervals; the storage tests to 2000 hours. This is equivalent to group C.
3. This is an annual check.



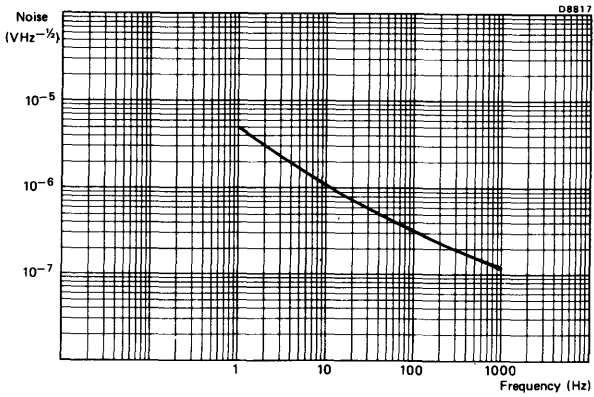
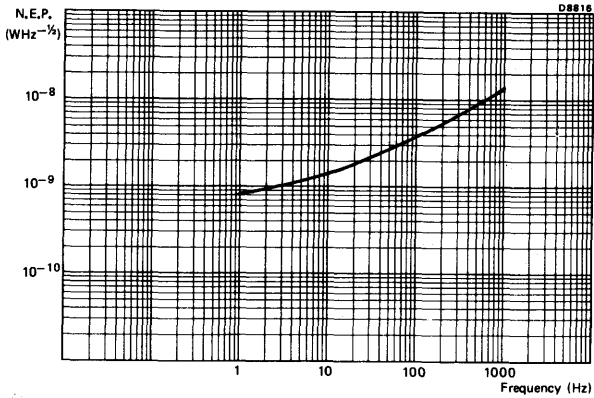
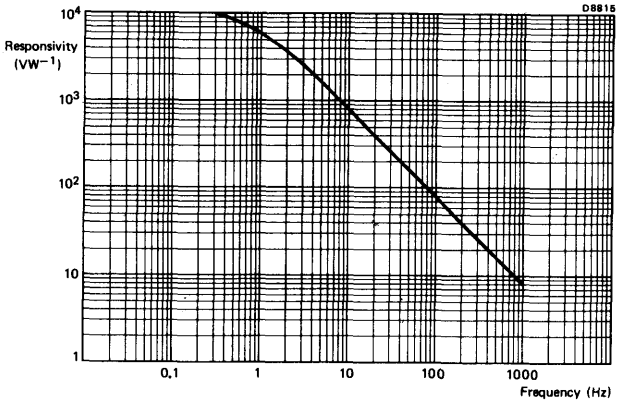

Typical responsivity, N.E.P., and noise as a function of frequency (one element screened)



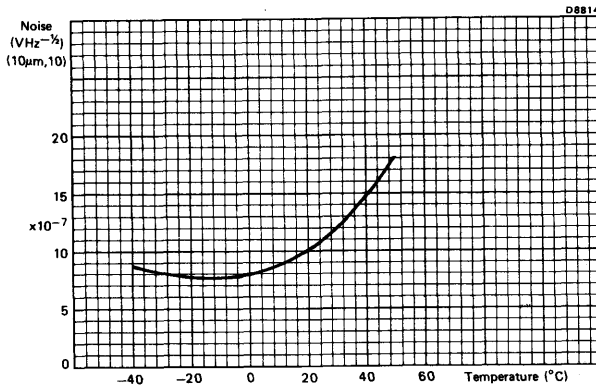
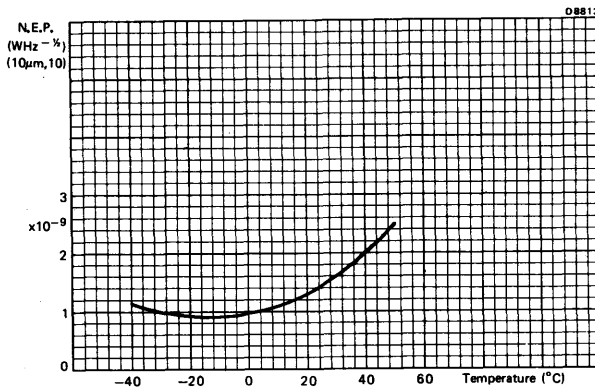
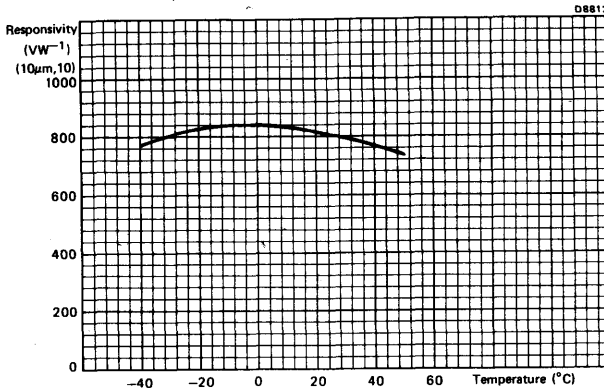

Typical responsivity, N.E.P., and noise as a function of temperature  
(one element screened)



POLAR DIAGRAMS – ELEMENT a

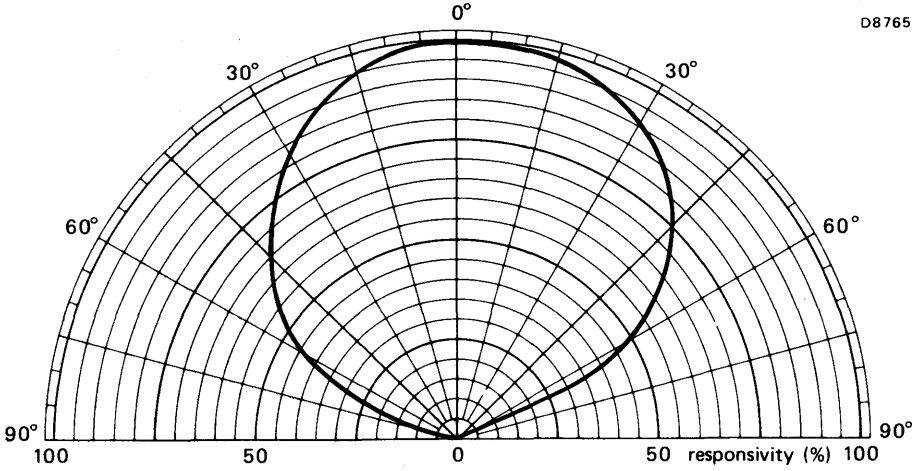

D8765

Typical field of view in x-x plane (see mechanical data)

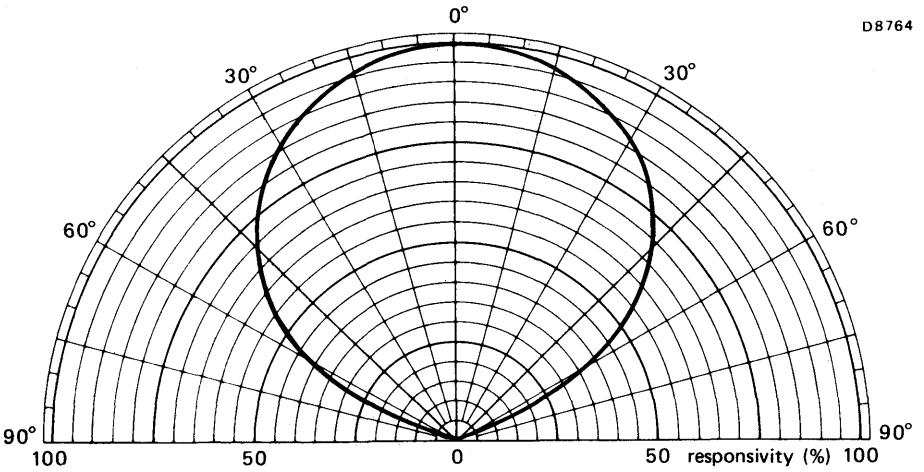

D8764

Typical field of view in y-y plane (see mechanical data)



POLAR DIAGRAMS – ELEMENT b

D8767

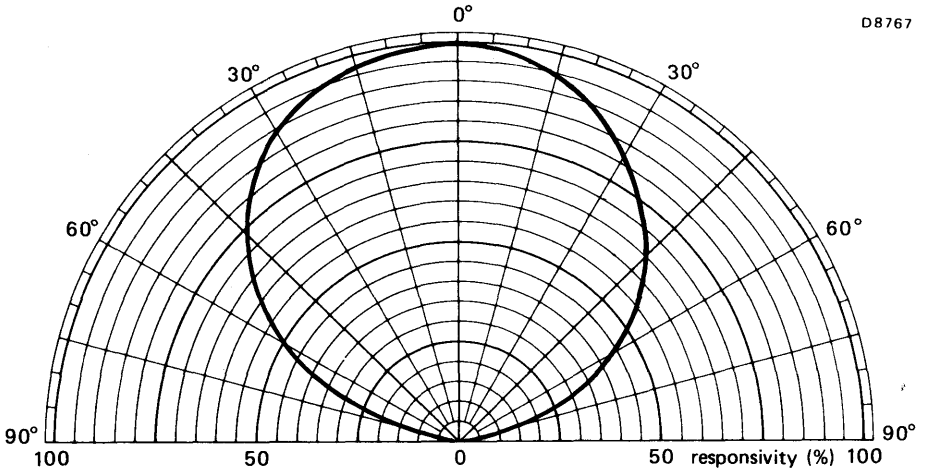

Typical field of view in x-x plane (see mechanical data)

D8766

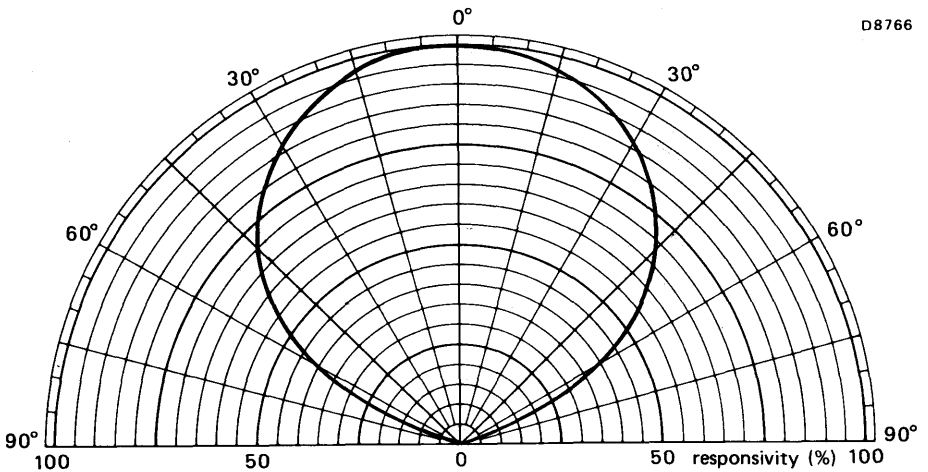

Typical field of view in y-y plane (see mechanical data)



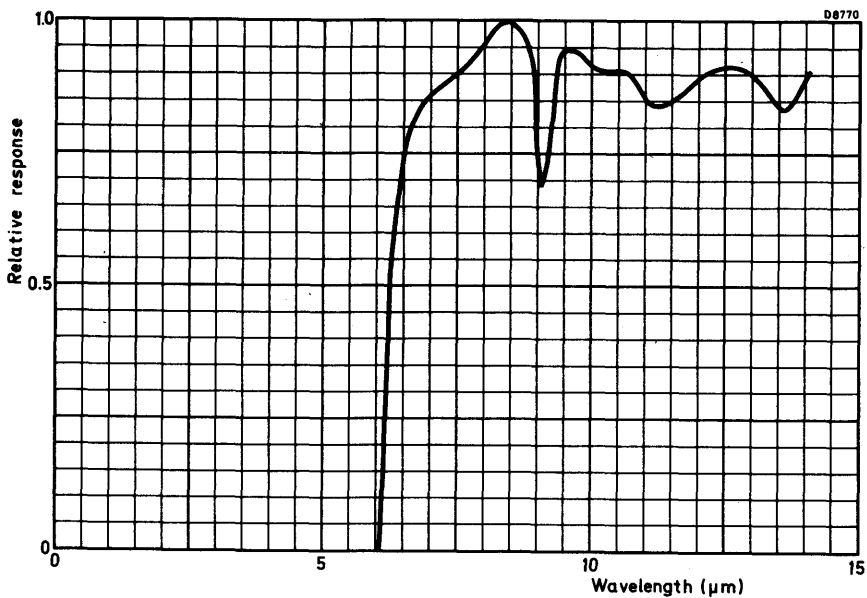

Typical window transmission characteristic



## PYROELECTRIC INFRARED DETECTOR

This is an infrared sensitive device, combined with a pre-amplifier which is stabilized to overcome d.c. drift due to thermal changes. It is sealed in a low-profile TO-5 can.

### QUICK REFERENCE DATA

Spectral response		$6.5 \pm 0.5$ to $> 14$	$\mu\text{m}$
Responsivity, (10 $\mu\text{m}$ , 10)	typ.	130	$\text{VW}^{-1}$
Noise Equivalent Power (N.E.P.), (10 $\mu\text{m}$ , 10, 1)	typ.	$3.5 \times 10^{-9}$	$\text{WHz}^{-1/2}$
Element dimensions		$2 \times 1$	mm
Field of view	typ.	104	degrees
Operating voltage		9	V
Optimum operating frequency range		0.1 to 1000	Hz

This data must be read in conjunction with GENERAL SAFETY RECOMMENDATIONS – OPTOELECTRONIC DEVICES

### MECHANICAL DATA

Dimensions in mm

#### SOT-49F (low profile TO-5)

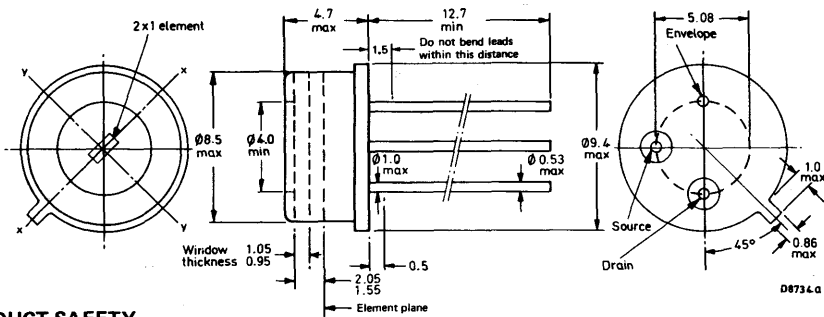

### PRODUCT SAFETY

Modern high technology materials have been used in the manufacture of this device to ensure high performance. Some of these materials are toxic in certain circumstances. Mechanical or electrical damage is unlikely to give rise to any hazard, but toxic vapours may be generated if the device is heated to destruction. Disposal of large quantities should therefore be carried out in accordance with the Deposit of Poisonous Waste Act 1972 and the Control of Pollution Act 1974, or with the latest legislation.



**RATINGS**

Limiting values in accordance with the Absolute Maximum System (IEC134)

Operating voltage at 100 °C	max.	30	V
Temperature, operating	max.	+60	°C
	min.	-40	°C
Temperature, storage	max.	+70	°C
	min.	-40	°C

**SOLDERING**

1. When making soldered connections to the leads, a thermal shunt must be used.
2. It is essential that any mains operated soldering iron used should be both screened and earthed. Failure to observe these precautions could lead to the introduction of line voltage and possible damage to the device.

**CHARACTERISTICS** (at  $T_{amb} = 25 \pm 3$  °C and with the test circuit).

	min.	typ.	max.	
Responsivity (10 $\mu\text{m}$ , 10), notes 1 and 4	—	130	—	VW <sup>-1</sup>
N.E.P. (10 $\mu\text{m}$ , 10, 1) notes 1 and 4	—	$3.5 \times 10^{-9}$	$9 \times 10^{-9}$	WHz <sup>-1/2</sup>
Spectral response	$6.5 \pm 0.5$	—	> 14	$\mu\text{m}$
Field of view, note 2	—	105	—	degrees
Operating voltage, note 3	8	9	10	V

**Notes**

1. These characteristics apply throughout the spectral response range.
2. Field of view to 50% of the maximum responsivity level.
3. The detector will operate outside the quoted range but may have a degraded performance.
4. For performance as a function of frequency and temperature, see pages 4 and 5.

**TEST CIRCUIT**

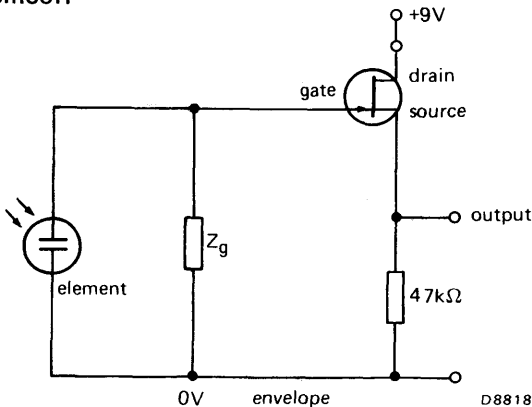



**OPERATING NOTES**

1. The case potential must not be allowed to become positive with respect to the other two terminals.
2. The shape of the electrical output waveform is the integral of the incident radiation waveform.
3. It is inadvisable to operate the detector at mains related frequencies.
4. To avoid the possibility of optical microphony, the detector must be firmly mounted.
5. An increase in temperature of the element will produce a negative going signal at the output.

**DEFINITIONS**

1. N.E.P. (Noise Equivalent Power),  $\text{WHz}^{-1/2}$

This is the r.m.s. value of the incident, chopped, radiant power necessary to produce an r.m.s. signal to r.m.s. noise ratio of unity. The r.m.s. noise refers to the value calculated for unit square root bandwidth  $\text{VHz}^{-1/2}$ .

2. Responsivity  $\text{VW}^{-1}$

This is the ratio of the r.m.s. signal in volts to the r.m.s. value of the incident, chopped, radiant power.

**MECHANICAL AND ENVIRONMENTAL STANDARDS**

As part of the Quality Assurance programme, the detectors are assessed at regular intervals against the requirements of the following IEC standards. The frequency of testing and the limits and conditions for the pre- and post-test measurements are based on those stipulated for the CECC 50 000 series of approved transistors.

			note
IEC 68-2-3	Test Ca	Moisture Resistance, steady state	1
68-2-20	Test T	Solderability	1
68-2-21	Test Ub	Lead Fatigue	1
68-2-1	Test A	Low Temperature Storage	2
68-2-2	Test Ba	High Temperature Storage	2
68-2-14	Test Nb	Change of Temperature (10 cycles)	2
68-2-6	Test Fc (B4)	Vibration, swept frequency	2
68-2-7	Test Ga	Acceleration, steady state	2
68-2-27	Test Ea	Shock	2
68-2-20	Test T	Resistance to Solder Heat	3

**Notes**

1. The detectors are checked on a production batch release principle at approximately weekly intervals. This is equivalent to group B.
2. The detectors are checked at quarterly intervals; the storage tests to 2000 hours. This is equivalent to group C.
3. This is an annual check.



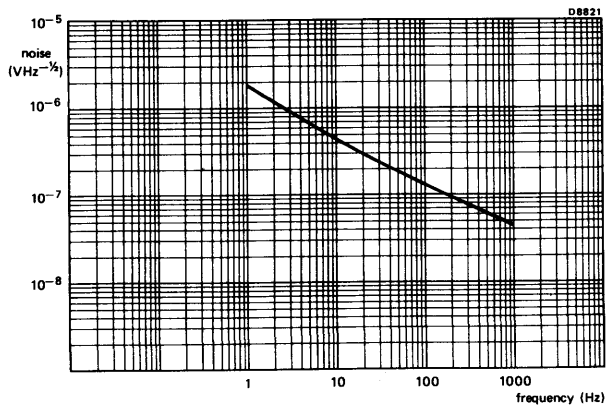
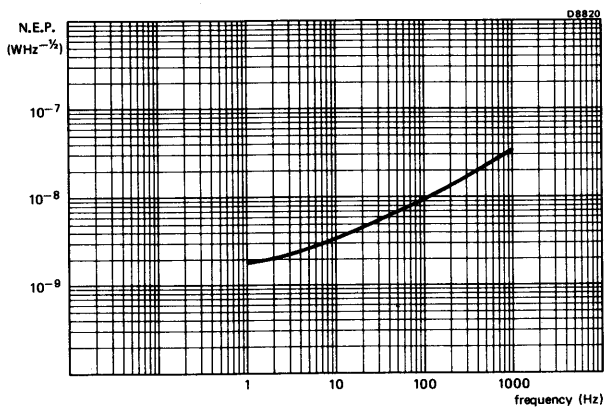
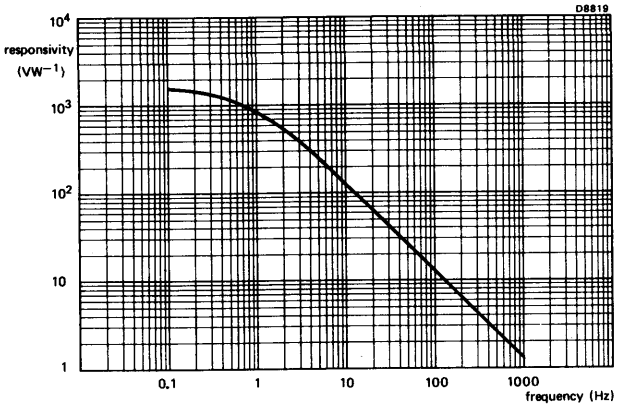

Typical responsivity, N.E.P., and noise as a function of frequency



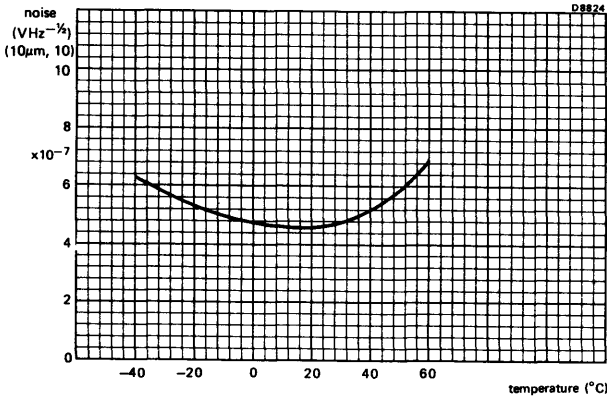
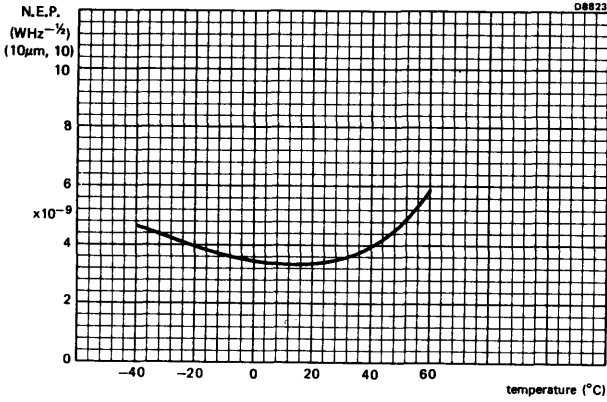
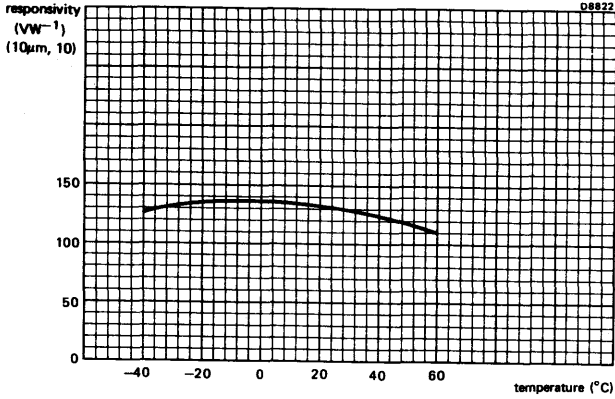

Typical responsivity, N.E.P., and noise as a function of temperature



POLAR DIAGRAMS

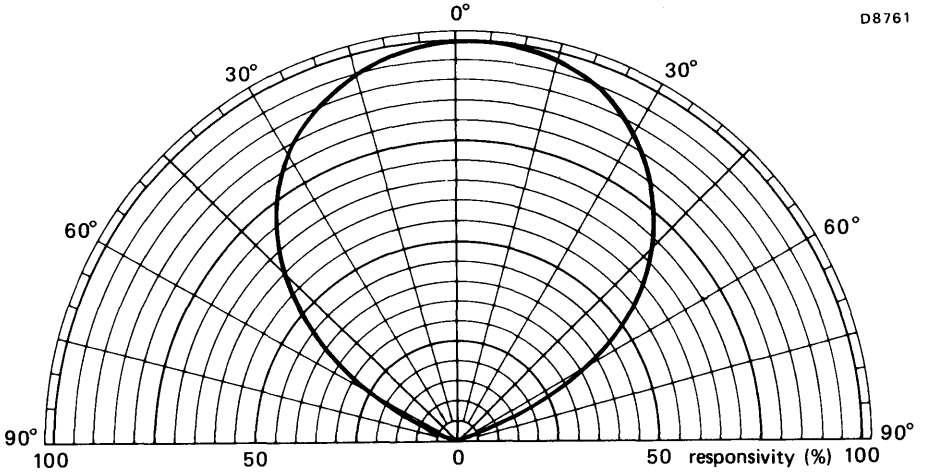

Typical field of view in x-x plane (see mechanical data)

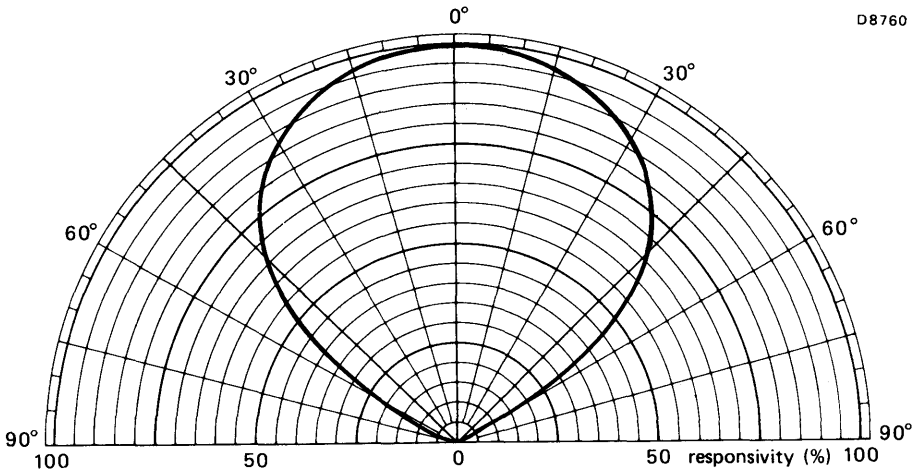

Typical field of view in y-y plane (see mechanical data)



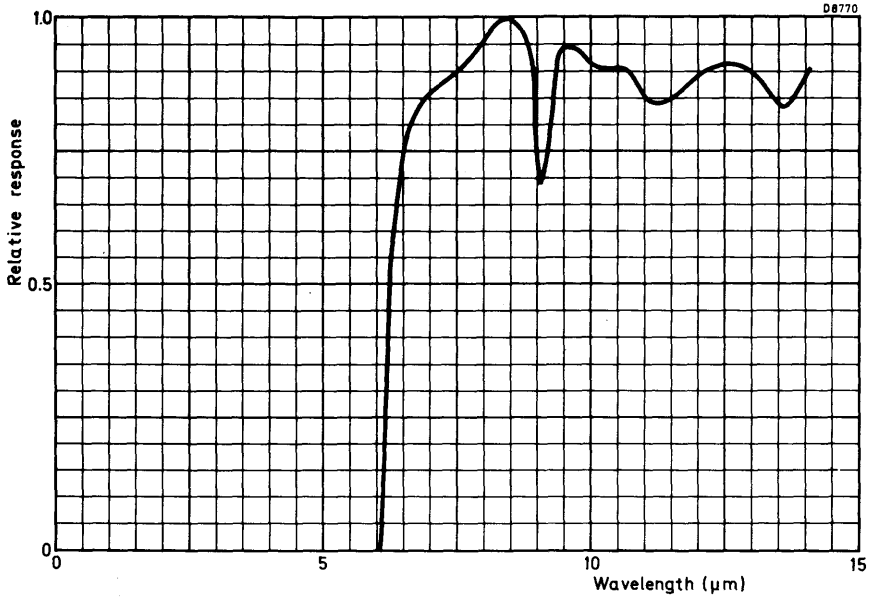

Typical window transmission characteristic





## INFRARED DETECTOR

Evaporated lead sulphide photoconductive cell with sensitive element mounted in a glass dewar. The cell is supplied in an envelope encapsulated for room temperature operation. The spectral response covers the range 0.3 to 3.5  $\mu\text{m}$  and the cell is intended for use with pulsed or modulated radiation.

### QUICK REFERENCE DATA

Wavelength at peak response	2.2	$\mu\text{m}$
Resistance	1.5	$\text{M}\Omega$
Responsivity (2.0 $\mu\text{m}$ )	$8.0 \times 10^4$	$\text{VW}^{-1}$
$D^*$ (2.0 $\mu\text{m}$ , 800, 1)	$4.0 \times 10^{10}$	$\text{cmHz}^{1/2}\text{W}^{-1}$
Time constant	100	$\mu\text{s}$
Sensitive area	$6.0 \times 6.0$	$\text{mm}$

This data must be read in conjunction with GENERAL SAFETY RECOMMENDATIONS – OPTOELECTRONIC DEVICES

### PRODUCT SAFETY

Modern high technology materials have been used in the manufacture of this device to ensure high performance. Some of these materials are toxic in certain circumstances. Mechanical or electrical damage is unlikely to give rise to any hazard, but toxic vapours may be generated if the device is heated to destruction. Disposal of large quantities should therefore be carried out in accordance with the Deposit of Poisonous Waste Act 1972 and the Control of Pollution Act 1974, or with the latest legislation.

### MECHANICAL DATA

Dimensions in mm

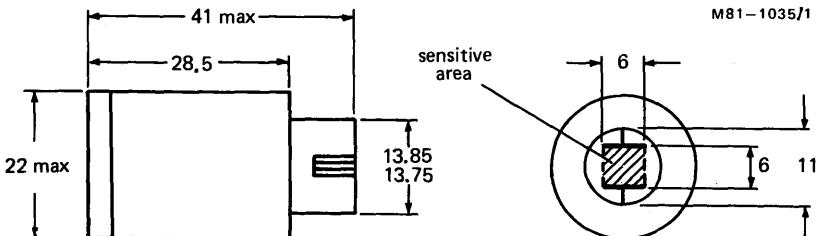

**RATINGS**

Limiting values in accordance with the Absolute Maximum System (IEC134)

**Electrical**

$V_{\text{cell max.}}$	250	V
$I_{\text{cell max.}}$	0.5	mA

**Temperature** (see note 3)

$T_{\text{amb max.}}$ (storage and operating)	+60	°C
$T_{\text{amb min.}}$ (storage and operating)	-55	°C

**CHARACTERISTICS** (at  $T_{\text{amb}} = 20$  °C under conditions specified in note 1)

Wavelength at peak response	2.2	$\mu\text{m}$
Spectral response range (see page 4)	0.3 to 3.2	$\mu\text{m}$
Cell resistance	min. 1.0	$\text{M}\Omega$
	typ. 1.5	$\text{M}\Omega$
	max. 4.0	$\text{M}\Omega$
Time constant (see note 2)	typ. 100	$\mu\text{s}$
Noise voltage	typ. 8.5	$\mu\text{V}$

**BLACK BODY PERFORMANCE** (see note 1)

Responsivity (500 K)	min. $2.0 \times 10^2$	$\text{VW}^{-1}$
	typ. $1.3 \times 10^3$	$\text{VW}^{-1}$
$D^*$ (500 K, 800, 1)	min. $2.0 \times 10^8$	$\text{cmHz}^{1/2}\text{W}^{-1}$
	typ. $6.5 \times 10^8$	$\text{cmHz}^{1/2}\text{W}^{-1}$
N.E.P. (500 K, 800, 1)	typ. $9.2 \times 10^{-10}$	$\text{WHz}^{-1/2}$
	max. $3.0 \times 10^{-9}$	$\text{WHz}^{-1/2}$

**MONOCHROMATIC PERFORMANCE** (see note 1)

Responsivity ( $2.0 \mu\text{m}$ )	typ. $8.0 \times 10^4$	$\text{VW}^{-1}$
$D^*$ ( $2.0 \mu\text{m}$ , 800, 1)	typ. $4.0 \times 10^{10}$	$\text{cmHz}^{1/2}\text{W}^{-1}$
N.E.P. ( $2.0 \mu\text{m}$ , 800, 1)	typ. $1.5 \times 10^{-11}$	$\text{WHz}^{-1/2}$





## NOTES

## 1. Test conditions

Characteristics are measured with the cell biased from a 200 V d.c. supply in series with a 1.0 M $\Omega$  load resistor. No correction is made for the loading effect of the 1.0 M $\Omega$  resistor, i.e. open circuit characteristics are not given.

The sensitive element is situated at a distance of 264 mm from a black body source limited by an aperture of 3 mm. The radiation path is interrupted at 800 Hz by a chopper blade at ambient temperature. Under these conditions the r.m.s. power at the element (chopping factor 2.2) is 4.5  $\mu\text{Wcm}^{-2}$ .

Measurements of the detector output are made with an amplifier tuned to 800 Hz with a bandwidth of 50 Hz.

The figures in brackets which follow responsivity, D\* and N.E.P. refer to the test conditions, for example, D\* (2.0  $\mu\text{m}$ , 800, 1) denotes monochromatic radiation incident on the detector of wavelength 2.0  $\mu\text{m}$ , modulation frequency 800 Hz, an electronic bandwidth of 1 Hz.

D\* and N.E.P.

These are figures of merit for the materials of detectors and are fully discussed in most text books on infrared.

D\* is defined in the expression:

$$D^* = \frac{\frac{V_s}{V_n} \times [A(\Delta f)]^{1/2}}{W}$$

where  $V_s$  = Signal voltage across detector terminals

$V_n$  = Noise voltage across detector terminals

A = Detector area

( $\Delta f$ ) = Bandwidth of measuring amplifier

W = Radiation power incident on detector sensitive element (r.m.s. value, in watts)

The Noise Equivalent Power (N.E.P.) is related to D\* by the expression:

$$\text{N.E.P.} = \frac{(A)^{1/2}}{D^*}$$

Variation of performance with bias current

Both signal and noise vary with bias current in this type of cell. Typical curves are shown on page 5. At high currents the noise increases more rapidly than the signal and therefore the signal-to-noise ratio has a peak value at some optimum current, which will vary from cell to cell.

## 2. Time constant

Detector time constant figures are based on the response to a step function in the incident radiation. Quoted times indicate the interval between the moment the radiation is cut off and the output falling to 63% of its peak value.

## 3. Variation of performance with ambient temperature

The performance of the cell is dependent on the ambient temperature. Correction factors for the variation of performance are given on page 7.

## 4. Warning

Prolonged exposure to visible radiation should be avoided.



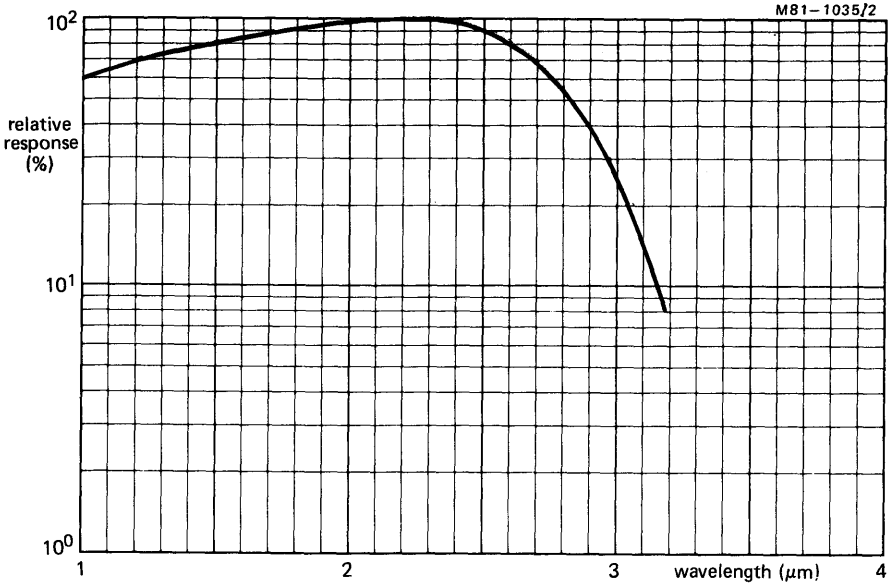

Typical spectral response at 20 °C

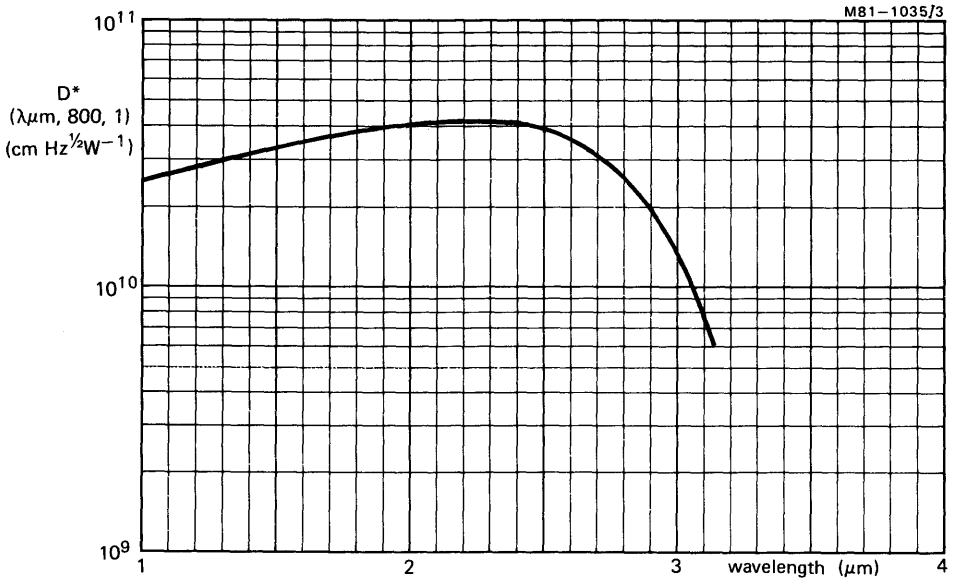

Typical  $D^*$  as a function of wavelength



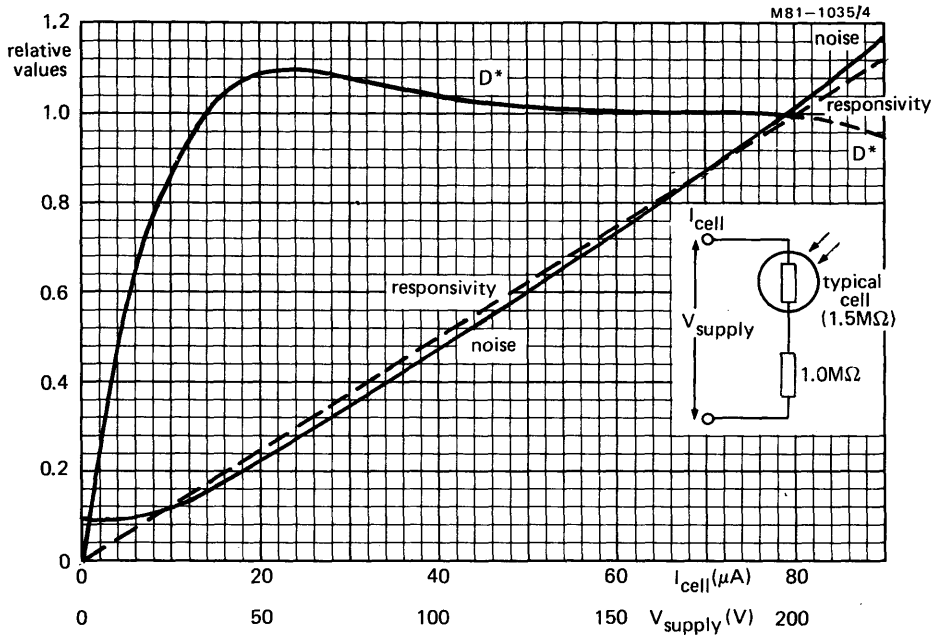

Typical  $D^*$ , responsivity and noise as functions of cell current  
 The values given are for a typical cell ( $1.5 M\Omega$ ) in series with a  $1 M\Omega$  resistor, and are relative to the values at  $V_{supply} = 200 V$ , corresponding to a cell current of  $80 \mu A$

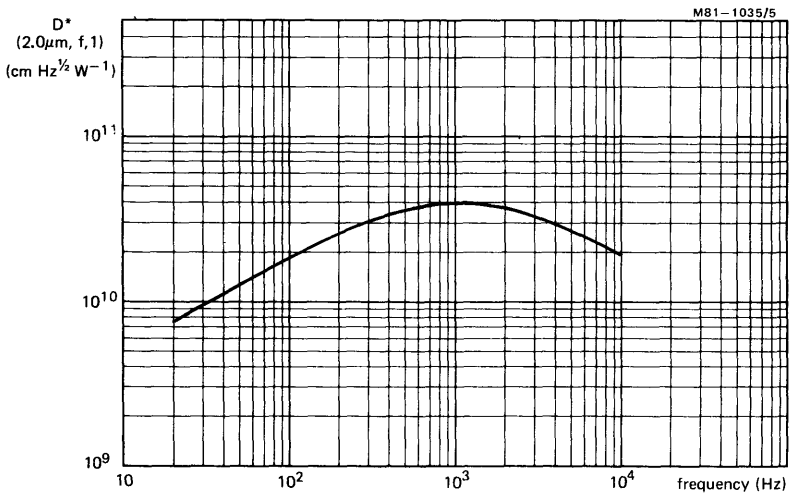

Typical  $D^*$  as a function of frequency



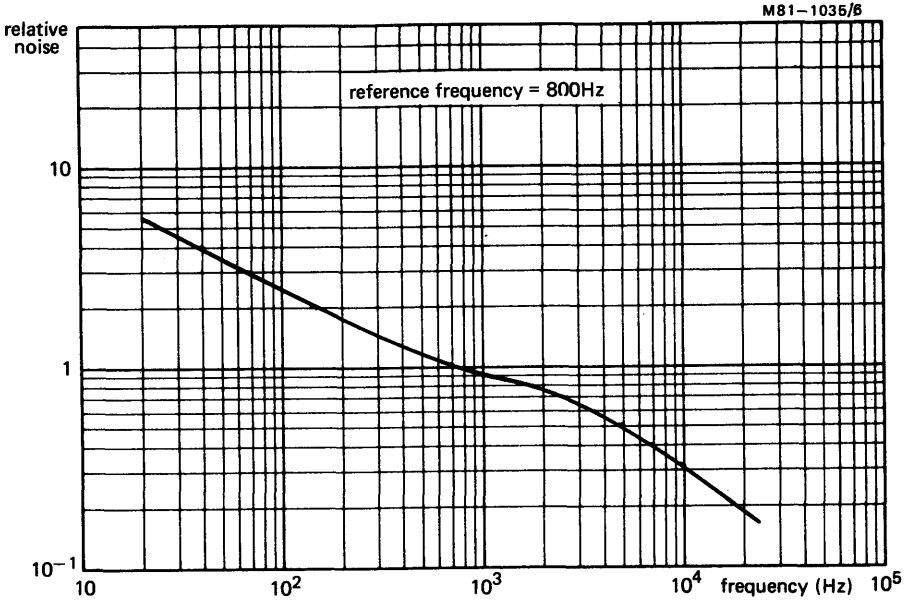

Typical relative noise as a function of frequency

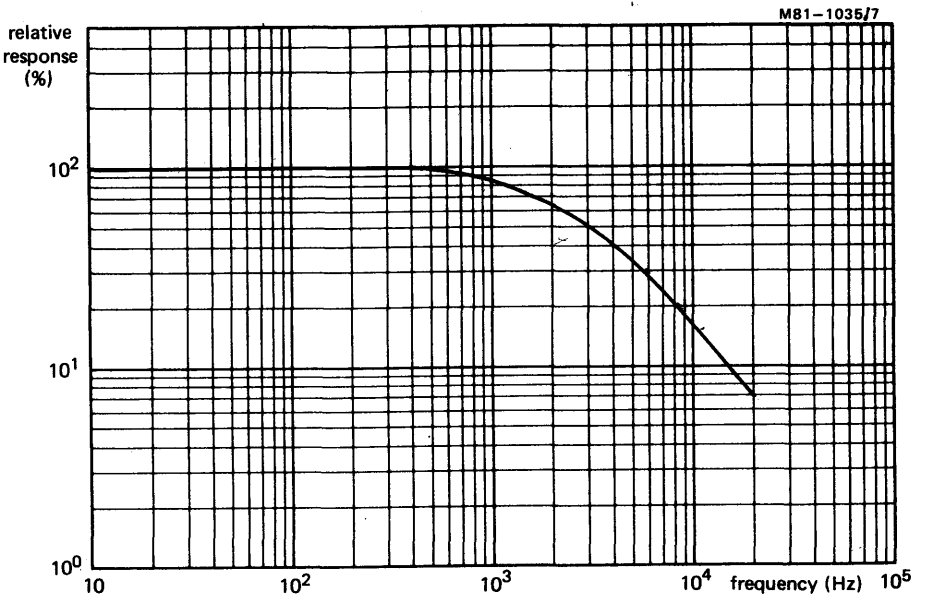

Typical relative response as a function of frequency



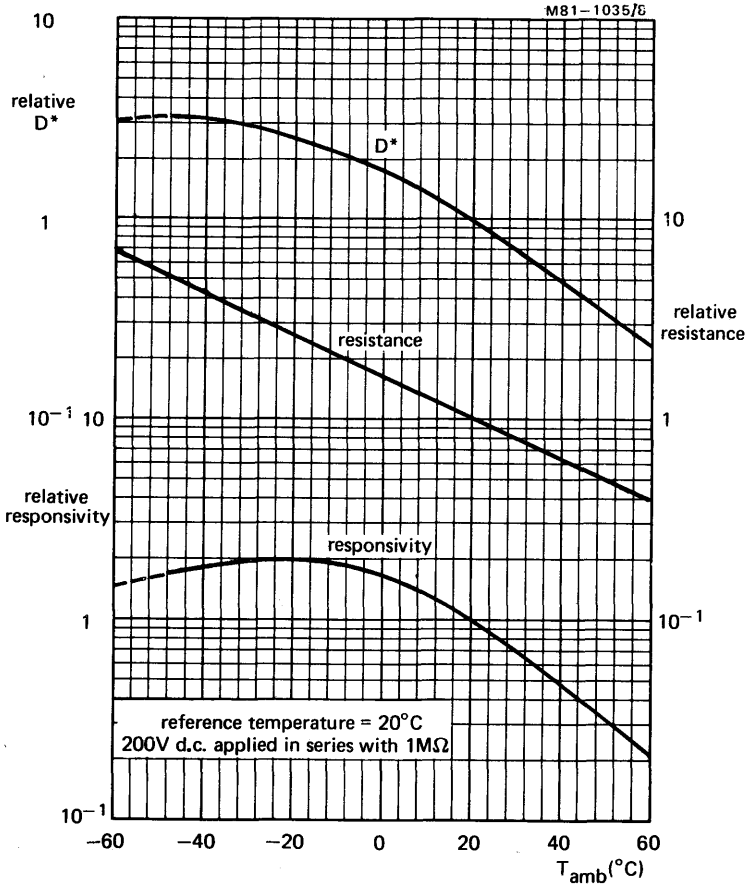

Typical relative values of  $D^*$ , resistance and responsivity as functions of ambient temperature



M81-1035/9

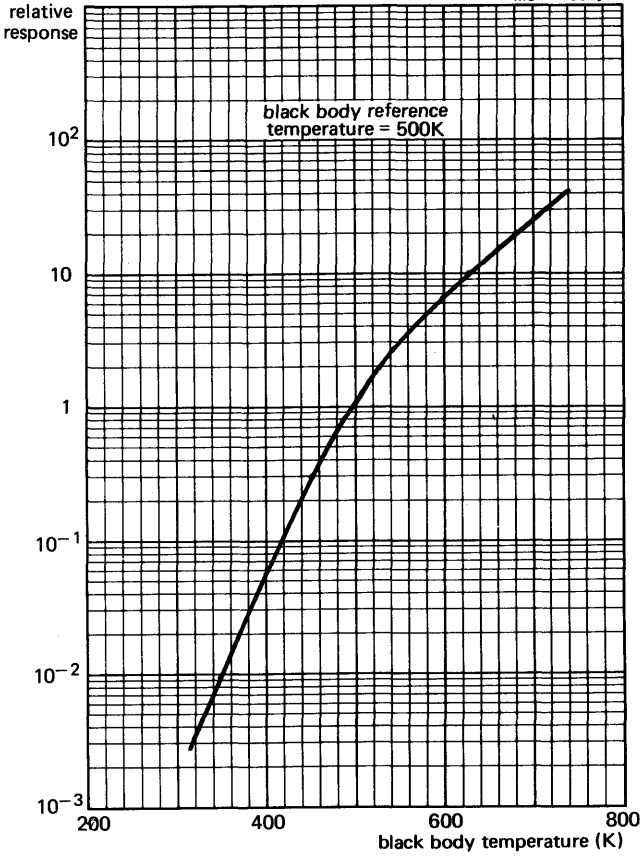

Typical relative response as a function of black body temperature.



**CUSTOM BUILT TGS  
PYROELECTRIC INFRARED  
DETECTORS**

**802CPY  
825CPY**



## 802CPY AND 825CPY HIGH-PERFORMANCE SELF-POLING TGS PYROELECTRIC INFRARED DETECTORS

The 802CPY and 825CPY series are fast broadband pyroelectric infrared detectors, operating at room temperature and designed as rugged replacements for conventional thermopile detectors. Each detector consists of an infrared-sensitive element, an infrared window, and an impedance-matching preamplifier. The sensitive element is a flake of L-alanine-doped\* triglycine sulphate (LATGS), with metallic electrodes deposited on opposite faces. As a result of the pyroelectric nature of the crystal, an electrical signal is obtained from the electrodes in response to changes in temperature.

A discussion on pyroelectricity and noise in pyroelectric detectors is given in Ref.1. This reference describes the RPY90 and RPY91 series pyroelectric detectors, which have similar performance characteristics to the 802CPY and 825CPY series but are housed in a 'stalk' encapsulation (MO59).

### DEVICE DESCRIPTION

The 802CPY series detectors have circular elements which are available in three diameters: 2 mm, 3 mm and 4 mm. Each element is supported over the major portion of the sensitive area. This 'solid mounting' is designed to cope with vibration and shocks and is intended for use at frequencies above 30 Hz. The standard preamplifier supplied with the detector has a voltage gain of 5, so that output falls with frequency.

The 825CPY series are available in four sizes with rectangular elements: 0.5 x 0.5 mm, 3 x 1 mm, 2 x 2 mm and 3 x 2 mm; each element being supported outside the sensitive area. This 'suspended mounting' is designed for applications which require the ultimate in performance at frequencies below 30 Hz. The standard preamplifier for the 825CPY series is frequency compensated, giving a substantially flat response up to 30 Hz.

The encapsulations of both series are identical, the only difference being in the position of the element plane.

The spectral range of each device is determined by the window material used. Spectral ranges for each available type of window are summarised in Table 1. For window materials of silicon and germanium, anti-reflection coatings are used to improve transmission in the 8 to 14  $\mu$ m region.

The devices are rated as follows (absolute maximum system).

Supply voltage	18 V
Supply current	10 mA
Operating temperature	-20 to +45 °C
Storage temperature	-20 to +55 °C

\*L-alanine doping is a Mullard patented process.





Table 1

Window material	Spectral range $\mu\text{m}$	Comments
Polythene	20 to 1000	Translucent, non-hygroscopic
CsI	1 to 60	Transparent in visible, hygroscopic, soft
KRS-5	1 to 40	Non-hygroscopic, toxic
Quartz	60 to 1000	Translucent, non-hygroscopic
Bloomed silicon	1.2 to 15*	Non-hygroscopic
Bloomed germanium	1.8 to 23*	Non-hygroscopic

\*Optimum transmission at 10  $\mu\text{m}$

### PYROELECTRICITY

Operation of a TGS infrared detector is based on the pyroelectric effect. Below a temperature known as the Curie point, ferroelectric materials, such as TGS, exhibit a large spontaneous electrical polarisation. If the temperature of such a material is altered, for example by incident radiation, the polarisation changes. This change in polarisation may be observed as an electrical signal by evaporating electrodes on opposite faces of a thin flake of the material to form a capacitor. When the polarisation changes, the charges induced on the electrodes can either be made to flow as a current through a comparatively low external impedance, or to produce a voltage across the element if the external impedance is comparatively high. The detector will only produce an electrical output signal when the temperature changes; that is, when the level of incident radiation changes.

When pure TGS is raised above its Curie point of 49 °C, it loses its polarisation and does not regain it on cooling. However, L-alanine doping produces an internal electric field which reposes the crystal when the temperature falls below the Curie temperature. Operation will thus always be restored when the temperature falls below 49 °C.

### DEFINITIONS

#### Noise

In most applications which use a high-performance detector, noise will play an important part in determining the ultimate performance of the system. In the published data, r.m.s. noise voltage is followed by figures in brackets, for example (10, 1). These indicate that the noise is measured for a chopping frequency of 10 Hz, and with a bandwidth normalised to 1 Hz. As the noise is proportional to the square root of bandwidth, the units are microvolts per root hertz. A full discussion on the various sources of the noise and its dependence on frequency is given in Ref. 1.

#### Responsivity

The responsivity is defined simply as the ratio of the r.m.s. signal voltage to the r.m.s. radiant power which produces it. The units of responsivity are volts per watt. As with noise data, published values of responsivity are followed by figures in brackets, for example (500 K, 10). These indicate that the responsivity is measured for a black-body source at 500 K and with a chopping frequency of 10 Hz. In practice, the responsivity is not very dependent on wavelength, but it is strongly dependent on chopping frequency, falling as the reciprocal of the frequency.



**DEFINITIONS** (continued)

**Noise equivalent power (N.E.P.)**

N.E.P. is a measure of the minimum power that can be detected. It is the r.m.s. radiant power incident upon the detector which produces at the output an r.m.s. signal equal in magnitude to the r.m.s. detector noise. Since N.E.P. can be calculated from dividing noise by responsivity, it has the units of watts per root hertz and published figures are accompanied by details of black-body temperature, chopping frequency and bandwidth, for example (500 K, 10, 1).

**PERFORMANCE**

Typical performance data is given in Tables 2 and 3. The measurements were made at the preamplifier output, using a 500 K black-body source. The ambient temperature was 20 °C.

**Table 2** 802CPY typical performance data (CsI window, 2 mm diameter element)

			Unit
N.E.P. (500 K, 90, 1)		$8.0 \times 10^{-10}$	WHz <sup>-1/2</sup>
Responsivity (500 K, 90)		$8.5 \times 10^2$	VW <sup>-1</sup>
Noise (90, 1)		0.7	µVHz <sup>-1/2</sup>
Output voltage	(typ.)	6	V
	(min.)	4	V
Output impedance	(max.)	4	kΩ
Preamplifier gain		x5	

**Table 3** 825CPY typical performance data (CsI window 3 x 1 mm element)

			Unit
N.E.P. (500 K, 10, 1)		$1.6 \times 10^{-10}$	WHz <sup>-1/2</sup>
Responsivity (500 K, 10)		$1.5 \times 10^5$	VW <sup>-1</sup>
Noise (10, 1)		24	µVHz <sup>-1/2</sup>
Output voltage	(typ.)	6	V
	(min.)	4	V
Output impedance	(max.)	2	kΩ
Preamplifier gain (at 10 Hz)		x100	



**Spectral response**

The LATGS element responds to infrared wavelengths from about  $1\ \mu\text{m}$  to the submillimetre region. The spectral response is substantially flat between  $3$  and  $50\ \mu\text{m}$ . Fig.1 shows the transmission characteristics of the various window materials used with 802CPY and 825CPY series detectors.

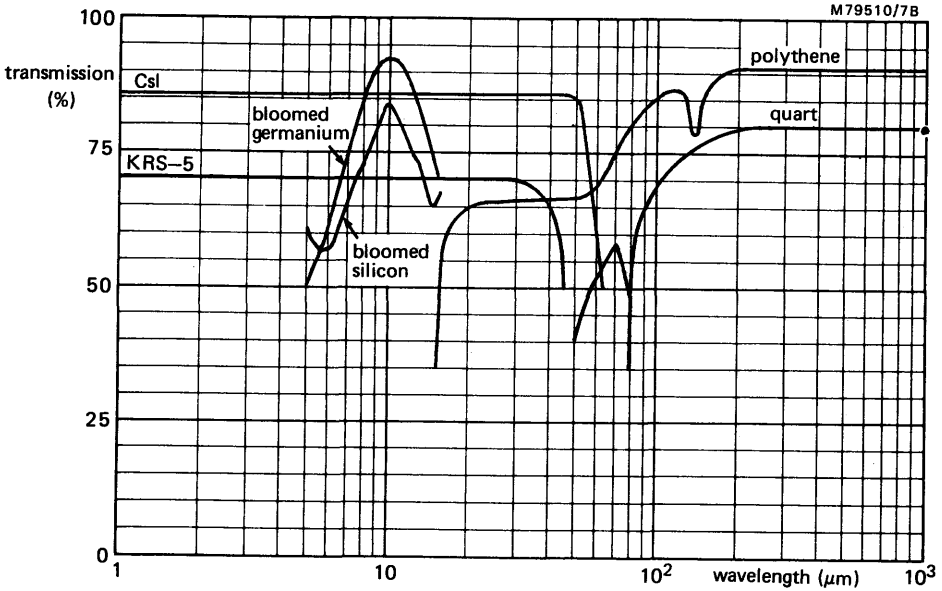

Fig.1 Window transmission characteristics

**FURTHER INFORMATION**

This may be found in Mullard Technical Publication No. M80-0043.

Detectors may be supplied to individual customer's requirements. Contact the Semiconductor Optoelectronics group at Mullard Ltd., Mullard House, Torrington Place, London WC1E 7HD.

**REFERENCE**

1. 'High-performance TGS pyroelectric infrared detectors', Technical Note 114, TP1743/1, Mullard Limited, 1979.



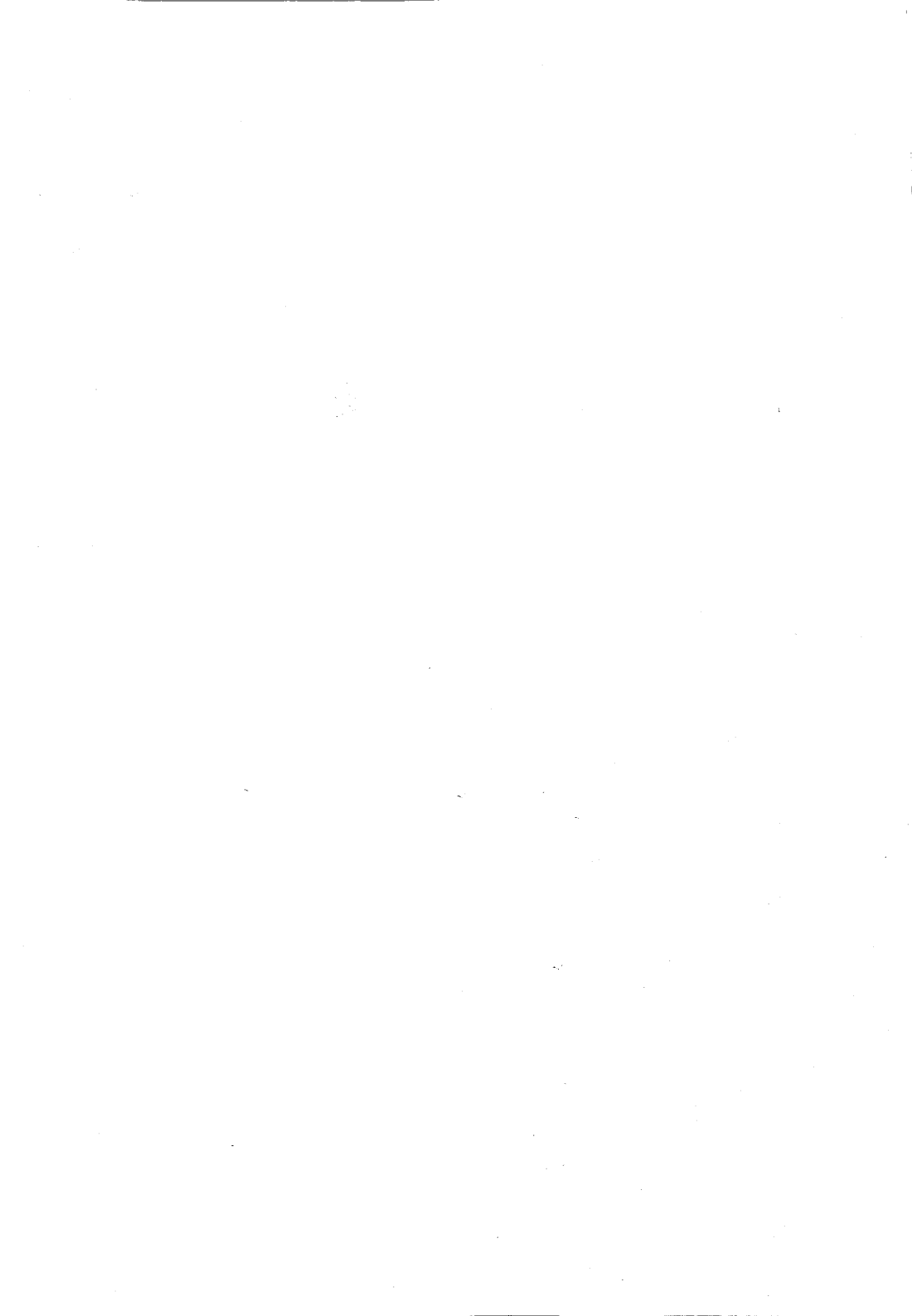

# **CUSTOM BUILT CMT INFRARED DETECTORS**

**F** 

## 8 TO 14 $\mu\text{m}$ SINGLE-ELEMENT CMT INFRARED DETECTORS

A range of single-element CMT (cadmium mercury telluride) photoconductive infrared detectors is available and is intended for operation at 77 K in the 8 to 14  $\mu\text{m}$  atmospheric window. They are fast high-performance detectors with  $D^*$  ( $\lambda_{pk}$ , 5 kHz, 1) values of typically  $4 \times 10^{10} \text{ cmHz}^{1/2}\text{W}^{-1}$  and time-constants of typically 0.3  $\mu\text{s}$ .

The detectors are available with a range of standard element sizes, and are supplied in encapsulations suitable for cooling by bulk liquid nitrogen, liquid transfer, or Joule-Thomson 'minicooler' systems. In addition to the standard elements (see Table 1), the supply of other configurations can be considered.

### RANGE OF STANDARD ELEMENTS

Dimensions and type numbers of standard single-element CMT infrared detectors, together with recommended cooling methods, are given in Table 1.

**Table 1** Single-element CMT infrared detectors

Element dimensions mm	Encapsulation	
	GC1A (Joule-Thomson or liquid transfer cooled)	GC13A (Bulk liquid cooled, duration about two hours)
0.050 x 0.050	J1010	J1020
0.115 x 0.125	J1012	J1022
0.225 x 0.225	J1013	J1023
0.5 x 0.5	J1014	J1024
1.0 x 1.0	J1015	J1025

The GC1A and GC13A are each fitted with an anti-reflection coated silicon window and a cooled radiation shield to limit the field of view.

### PERFORMANCE

The figures given in Table 2 are for the detectors operating at 77 K (ambient temperature of 20  $^{\circ}\text{C}$ ) with a field of view of 60 degrees.



Table 2 Performance data

Characteristics	Element dimensions (mm)				Unit
	0.050 x 0.050	0.115 x 0.125	0.225 x 0.225	0.5 x 0.5	
D* ( $\lambda_{pk}$ , 5 kHz, 1) (see text)	typ	4.4 x 10 <sup>10</sup>	2.9 x 10 <sup>10</sup>	2.4 x 10 <sup>10</sup>	cmHz <sup>1/2</sup> W <sup>-1</sup>
D* (500 K, 5 kHz)	min typ	1.5 x 10 <sup>10</sup> 2.0 x 10 <sup>10</sup>	1.3 x 10 <sup>10</sup> 1.7 x 10 <sup>10</sup>	0.9 x 10 <sup>10</sup> 1.1 x 10 <sup>10</sup>	cmHz <sup>1/2</sup> W <sup>-1</sup> cmHz <sup>1/2</sup> W <sup>-1</sup>
Responsivity (500 K, 800 Hz)	min	1 x 10 <sup>4</sup>	2 x 10 <sup>3</sup>	1 x 10 <sup>3</sup>	VW <sup>-1</sup>
Time-constant (see text)	typ max	0.3 1.0	0.5 1.0	0.7 1.0	$\mu$ s $\mu$ s
N.E.R. (5 kHz) (see text)	min	400	400	400	$\Omega$
Cut-off wavelength range		11.0 to 14.0	11.0 to 14.0	11.0 to 14.0	$\mu$ m
Spectral response		(see text)	(see text)	(see text)	
Detector resistance		20 to 200	20 to 200	20 to 200	$\Omega$
Bias current	typ	1	10	20	mA
Field of view		60	60	60	degree
<i>Ratings</i>					
Maximum bias current		3	30	50	mA
Storage temperature		-55 to +60	-55 to +60	-55 to +60	$^{\circ}$ C



**Area normalised detectivity  $D^*(\lambda_{pk})$**

The values of  $D^*(\lambda_{pk})$  are calculated from the measured values of  $D^*$  (500 K) and the spectral response curve for an ideal photon detector.

**Time-constant**

The time-constant is defined as the time interval between the cut-off of a pulse of radiation incident on the detector and the detector output falling to 37% of its peak value, under conditions of maximum detector sensitivity.

**Noise equivalent resistance**

Noise equivalent resistance (N.E.R.) is the value of resistance which at 20 °C would produce a Johnson noise voltage equivalent to the detector noise measured at 77 K.

**Noise**

Fig.1 shows the typical noise spectrum of 8 to 14  $\mu\text{m}$  CMT infrared detectors.

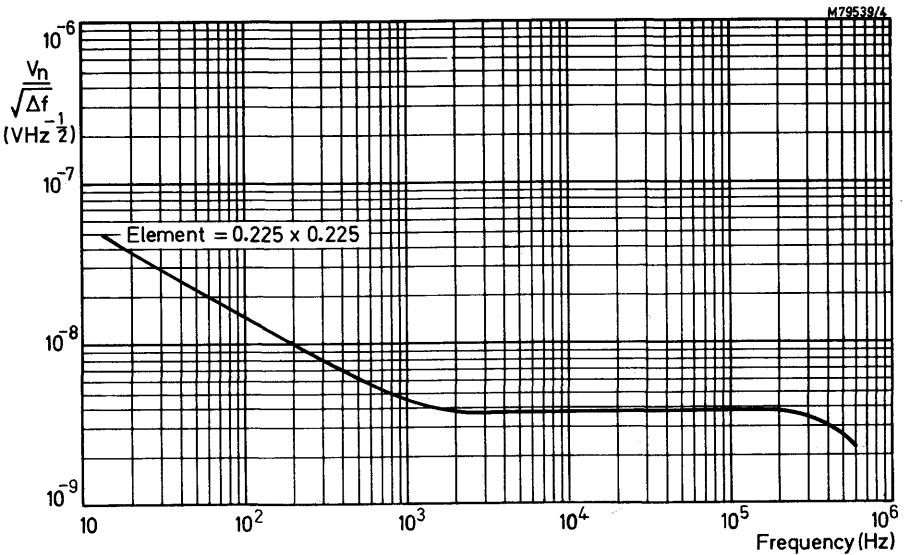

Fig.1 Typical noise spectrum of single-element CMT detector





**Spectral response**

The spectral response of 8 to 14  $\mu\text{m}$  CMT infrared detectors lies within the band shown in Fig.2. It is measured through the silicon window of the detector which has a quarter-wavelength single-layer anti-reflection coating on both sides. Detectors are normally specified in terms of the cut-off wavelength (50% of peak), rather than the peak wavelength.

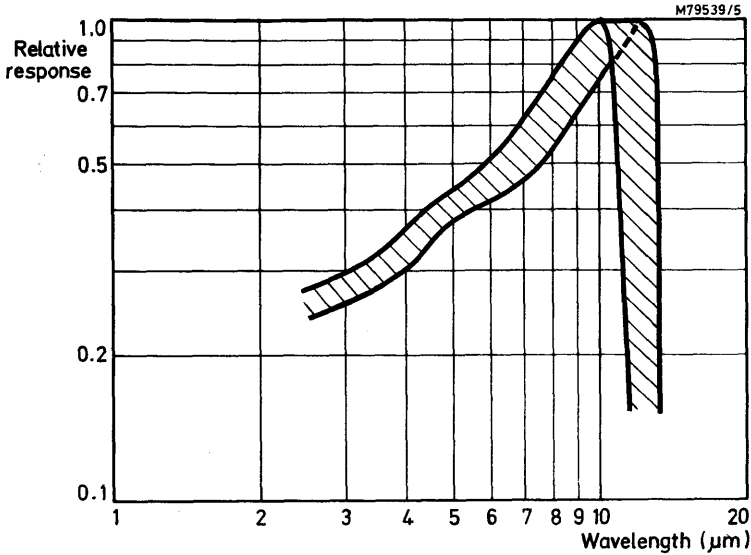

Fig.2 Spectral response of single-element CMT detector

**FURTHER INFORMATION**

This may be found in Mullard Technical Note No. 137 (TP1781).

Detectors may be supplied to individual customer's requirements. Contact the Semiconductor Optoelectronics group at Mullard Ltd, Mullard House, Torrington Place, London WC1E 7HD.





# **CADMIUM SULPHIDE PHOTOCONDUCTIVE CELLS**

**ORP60  
ORP61  
ORP69  
RPY58A**

**G** 



**G**

## GENERAL EXPLANATORY NOTES— CADMIUM SULPHIDE PHOTOCONDUCTIVE CELLS

These notes should be read in conjunction with Definitions for Optoelectronic Devices.

### GENERAL

A cadmium sulphide (CdS) photoconductive cell is a two terminal photoelectric semiconducting element without a defined junction.

The light sensitive coating may be manufactured by evaporation on to a base material by pressing, or by a single-grain process. Contact is made by evaporating low resistance electrodes on to the cadmium sulphide. These are normally in the form of interlinked combs. The number of fingers on these combs and their spacing per unit area governs the resistance and voltage ratings of the device.

The cell has the property of being an insulator in darkness but becoming a conductor when suitably illuminated. The resistance of the cell varies approximately in inverse proportion to the level of illumination.

### DATA PRESENTATION

In general, the data is divided into four main sections, quick reference data, cell characteristics, ratings and ruggedness (shock and vibration resistance).

#### Quick reference data

This section contains the main characteristics of the cell to allow rapid comparison with other cells. The information for circuit design should be obtained from the succeeding sections of the data. The characteristics usually given in the quick reference data are: maximum power dissipation at an ambient temperature of 25 °C, maximum cell voltage, nominal cell resistance at 50 lux illumination, sensitive area of the cell, maximum overall dimensions and any special features.

#### Characteristics

The characteristics and curves given in the data are typical, unless otherwise stated. The data given is measured at an ambient temperature of 25 °C, at a constant, uniform illumination, a colour temperature of 2700 K on the total light-sensitive area and with radiation perpendicular to the surface at the centre of the light-sensitive area. Measurements are made under d.c. conditions.

#### Cell sensitivity $S_R$

The spectral sensitivity of cadmium sulphide covers virtually the total visible range. At the end of these General Explanatory Notes the relative sensitivity of cadmium sulphide as a function of wavelength is shown as a general curve which is valid for almost all CdS photoconductive cells. A specific curve is given in the data where the variation is markedly different from the general curve mentioned above. The relative spectral sensitivity is determined by measuring for each wavelength range the monochromatic illumination required to obtain the same illumination resistance. As a result, the variation is independent of the relationship  $R = f(E)$ .



## Power dissipation

The heat dissipation occurring in a CdS photoconductive cell is limited by the maximum permissible temperature of the CdS chip. The maximum figure given in the data should not be exceeded. This figure is not only determined by the size and design of the cell but by the ambient temperature. Maximum power dissipation as a function of temperature is given in the data. It should be remembered that the ambient temperature will be affected by the heat emitted by the cell itself, unless precautions have been taken to provide a heatsink or adequate air cooling. This is particularly important if the maximum permissible rating is used.

The value of maximum power dissipation given in the data is for uniform illumination of the cell. If only part of the sensitive area is illuminated, the maximum power must be reduced in proportion to the area used. It is generally preferable to reduce the illumination by interposing a filter, rather than by using an iris to reduce the illuminated area.

## Ruggedness (shock and vibration resistance)

The conditions for shock and vibration given in the data are intended only to give an indication of the mechanical quality of a cell. It is not advisable to subject a cell to these maximum conditions.

## COLOUR TEMPERATURE

The normal way of specifying the colour of a light source is by means of its colour temperature. This is the temperature to which a black body would have to be raised to give a similar colour sensation to that produced by the light source under examination. Certain light sources (e.g. the sky) have a colour which cannot in practice be obtained by heating a black body, and to quote equivalent colour temperatures in these cases involves theoretical extrapolations. The colour temperature of the sky may be as high as 20 000 °K, but it is possible to simulate the colour source by the use of conventional tungsten lamps in conjunction with filters.

## C.I.E. Standard (Commission Internationale de l'Eclairage)

Although the C.I.E. standard illumination source A has a colour temperature of approximately 2856 K, to obtain test lamp stability, our CdS cells are normally measured at the lower colour temperature of 2700 K and our published characteristics are given for this illumination. For other light sources the cell resistance should be multiplied by the following approximate factors:

Source	Factor
Incandescent radiation at a colour temperature of:	
1500 K	0.5
* 2000 K	0.67
C.I.E, standard source A 2856 K	1.05
Sunlight	1.33
White fluorescent light (colour)	2.0

\*2000 K corresponds to light from an oil fired burner flame (yellow flame).



**CELL CHARACTERISTICS****Illuminated resistance**

When the illumination incident on a cell is changed the resistance changes to a value which is a function of the new illumination. The change is not immediate, and the resistance may overshoot as shown in Fig.1.

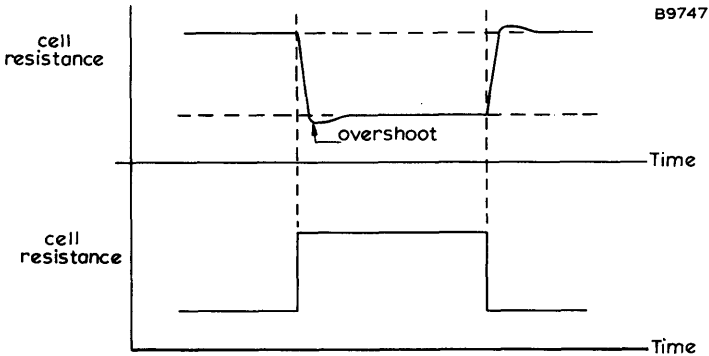

Fig.1

**Illuminated resistance (a.c. operation)**

When a cell is operated from an a.c. supply the effective resistance measured as  $|V/I|$  is usually greater than the resistance measured under d.c. conditions. Where a.c. resistance characteristics are not fully described, the a.c. resistance values at 50 Hz are approximately 1 to 1.3 times those for d.c. When using h.f. supplies there will be some change in impedance accompanied by a phase shift between the applied voltage and the cell current.

**DEFINITIONS**

The following terms are used in the data:

**Illuminated resistance** – the resistance of the cell when illuminated.

**Initial illuminated resistance** – the first virtually constant value of illuminated resistance after a change in illumination, usually after a change following 16 hours in complete darkness. (After 16 hours in darkness, changes in the cadmium sulphide material are still occurring, but have an insignificant effect on subsequent measurements).

**Equilibrium illuminated resistance** – the illuminated resistance after such a time that the rate of change of illuminated resistance is less than 0.2% per minute.

**Illuminated current** – the current which flows when a specified voltage is applied to the illuminated cell.

**Initial illuminated current** – the first virtually constant value of illuminated current after a change of illumination, usually after a change following 16 hours in complete darkness.

**Equilibrium illuminated current** – the illuminated current after such a time that the rate of change of illuminated current is less than 0.2% per minute.



**DEFINITIONS\*** (Continued)

**Dark resistance** – the resistance of the cell in complete darkness.

**Initial dark resistance** – the dark resistance at a specified time after a specified history.

**Equilibrium dark resistance** – the dark resistance after such a time that the rate of change of dark resistance is less than 0.2% per minute.

**Initial dark current** – the dark current at a specified time after a specified history.

**Equilibrium dark current** – the dark current after such a time that the rate of change of dark current is less than 0.2% per minute.

**Resistance rise time** – the time taken for the resistance of the cell to rise to a specified value after switching off a specified illumination after a specified history.

**Resistance decay time** – the time taken for the resistance of the cell to fall to a specified value, measured from the instant of switching on a specified illumination after a specified history.

**Current decay time** – the time taken for the current through the cell to fall to 10% of its value at the instant of switching off a specified illumination after a specified history.

**Current rise time** – the time taken for the current through the cell to rise to 90% of its initial illuminated current, measured from the instant of switching on a specified illumination after a specified history.

**Illumination sensitivity** – the illuminated current divided by the incident illumination.

**Temperature coefficient of illuminated resistance (current)** – the relationship between illuminated resistance (current) and variation of ambient temperature, under conditions of constant illumination and applied voltage. Within the normal operating range of the cells the temperature coefficient of illuminated resistance is typically -0.2% per °C.

**Initial drift** – the difference between the equilibrium and initial illuminated current, expressed as a percentage of the initial illuminated current.

**Illumination response** – the relationship between the initial illuminated resistance (R) and the illumination

(E), defined as 
$$\frac{\Delta \log R(\text{initial})}{\Delta \log E}$$

**Gamma** – the relationship between change in resistance and corresponding change in illumination,

defined as 
$$\frac{\log R_1/R_2}{\log E_2/E_1}$$
 where R<sub>1</sub> = resistance at illumination E<sub>1</sub> and R<sub>2</sub> = resistance at illumination E<sub>2</sub>.

**THERMAL DATA**

**Ambient temperature**

The ambient temperature is the temperature of the air surrounding the cell in its practical situation, which means that all other devices in the same space or apparatus must have their normal maximum dissipation and the normal apparatus envelope must be used.

The ambient temperature can normally be measured by means of a mercury thermometer with a blackened bulb, placed 5 mm from the cell in the horizontal plane through the centre of the effective area of the cadmium sulphide tablet. The thermometer should be exposed to substantially the same radiant energy as that incident on the cadmium sulphide tablet.

\*Other definitions common to more than one semiconductor optoelectronic device may be found under 'Definitions for Optoelectronic Devices'.





**MECHANICAL CONSIDERATIONS**

**Mounting position**

Unless otherwise stated in the published data, cells can be mounted in any position.

**Storage**

It is recommended that cells are stored in the dark. In any case direct sunlight should be avoided.

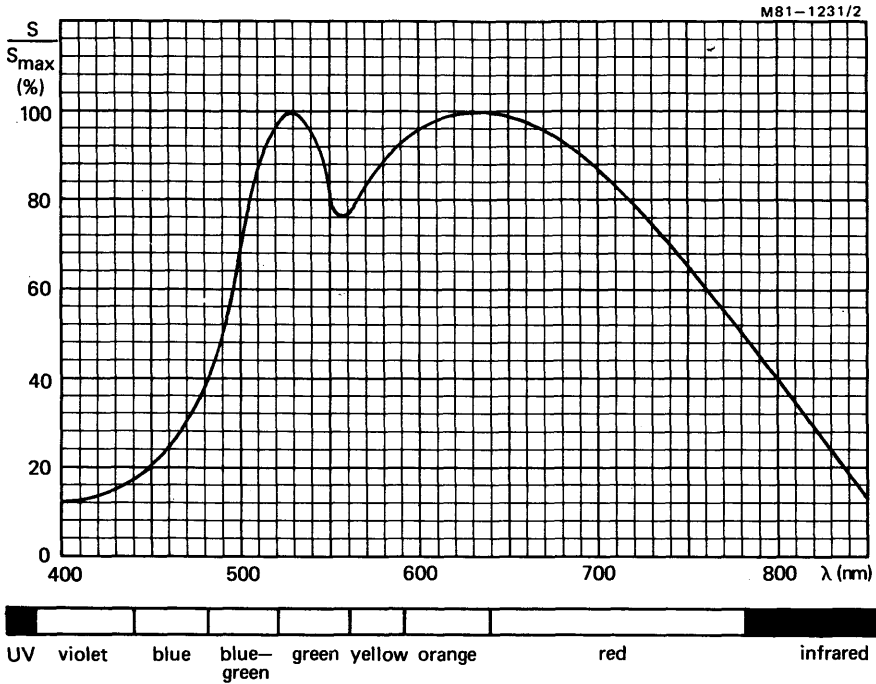

Fig.2 Typical relative spectral sensitivity of cadmium sulphide photoconductive cells.





## CADMIUM SULPHIDE PHOTOCONDUCTIVE CELL

End sensitive cadmium sulphide photoconductive cell in hermetically sealed glass envelope for applications such as flame failure circuits and for automatic brightness and contrast controls in television receivers.

### QUICK REFERENCE DATA

Power dissipation at $T_{amb} = 25\text{ }^{\circ}\text{C}$	P	max.	70	mW
Cell voltage, d.c. and repetitive peak	V	max.	350	V
Cell resistance at 50 lx, 2700 K colour temperature	$r_{lo}$	typ.	60	k $\Omega$

This data must be read in conjunction with GENERAL SAFETY RECOMMENDATIONS – OPTOELECTRONIC DEVICES

### MECHANICAL DATA

Dimensions in mm

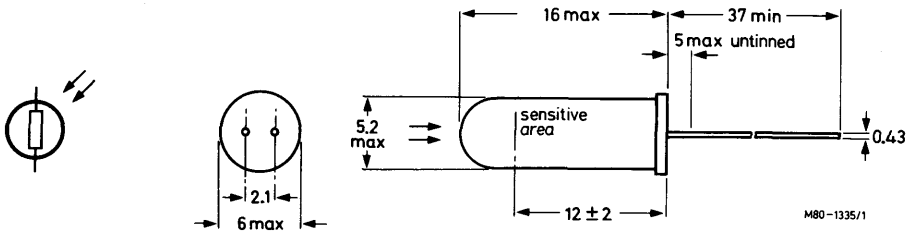

### POTENTIAL HAZARD – CADMIUM COMPOUND

Cadmium compounds are toxic. In the event of accidental breakage, cadmium dust may be released. Gloves should be worn and the dust should be mopped up with a damp cloth. Upon disposal, the cloth should be sealed in a plastic bag and the hands washed thoroughly with soap and water. Controlled disposal of devices containing cadmium compounds should be conducted in the open air or in a well ventilated area.

Inhalation of cadmium dust must be avoided.

This potential hazard is present, if breakage occurs, at all times from receipt to disposal of devices which should therefore be carried out in accordance with the Deposit of Poisonous Waste Act 1972 and the Control of Pollution Act 1974, or with the latest legislation.



**Soldering**

The cell may be soldered directly into the circuit but heat conducted to the tablet should be kept to a minimum by the use of a thermal shunt. The cell may be dip-soldered at a solder temperature of 240 °C for maximum of 10 s up to a point 5 mm from the seals.

**ELECTRICAL DATA**

**General**

The electrical properties of CdS cells are dependent upon many factors such as illumination, colour temperature of the light source, voltage, current, temperature, total time of operation and period of operation during the last 24 hours prior to measurement. The following basic characteristics are therefore only test points for the electrical properties of these devices.

**Basic characteristics at T<sub>amb</sub> = 25 °C, illumination colour temperature 2700 K.**

Initial dark resistance measured at 300 V d.c. applied via 1 MΩ, 20 s after switching off the illumination	r <sub>do</sub>	min.	200	MΩ*
Initial illumination resistance measured at 30 V d.c., illumination = 50 lx, after 16 hrs in darkness**	r <sub>lo</sub>	min.	37.5	kΩ
		typ.	60	kΩ
		max.	150	kΩ
Equilibrium illumination resistance measured at 30 V d.c., illumination = 50 lx, after 15 min under the measuring conditions	r <sub>le</sub>	min.	37.5	kΩ
		typ.	75	kΩ
		max.	190	kΩ
Negative temperature response of illumination resistance		typ.	0.2	%/°C
		max.	0.5	%/°C
Voltage response	$\frac{r \text{ at } 0.5 \text{ d.c.}}{r \text{ at } 30 \text{ V d.c.}}$	α	typ.	1.5

\* The spread of the dark resistance is large and values higher than 1000 MΩ are possible for the initial dark resistance.

\*\* After 16 hours in darkness changes in the CdS material are still occurring but have insignificant effect on the illumination resistance.



**RATINGS** Limiting values in accordance with the Absolute Maximum System (IEC 134)

Cell voltage d.c. and repetitive peak	V	max.	350 V
Cell voltage, pulse, $t_p \leq 5$ ms, $P_{rr} \leq$ once per minute	$V_M$	max.	500 V
Power dissipation ( $t_{av} = 2$ s) see graph $P_{max}$ .			
Power dissipation, pulsed	$P_M$	max.	$5 \times P_{max}$
Illumination	E	max.	50 000 lx
Temperature CdS tablet, operating	$T_{tablet}$	max.	85 °C
Ambient temperature, storage and operation	$T_{amb}$	min.	-40 °C
storage	$T_{stg}$	max.	50 °C*
operating	$T_{amb}$	max.	70 °C

**DESIGN CONSIDERATIONS**

Apparatus with CdS cells should be designed so that changes in the illumination resistance of the cells during life under rated load from -50% to +100% (typ. +50%) do not impair the circuit performance. Direct irradiation by sunlight should be avoided,

**RUGGEDNESS**

More than 95% of production passes the following shock and vibration tests.

**Shock**

25  $g_{peak}$ , 3000 shocks in each of the three positions of the cell.

**Vibration**

2.5  $g_{peak}$ , 50 Hz, during 32 hours in each of the three positions of the cell.

\*Operation of the cell counteracts the deteriorating effect of long periods at high temperature. The maximum operating temperature is therefore higher than the maximum storage temperature.



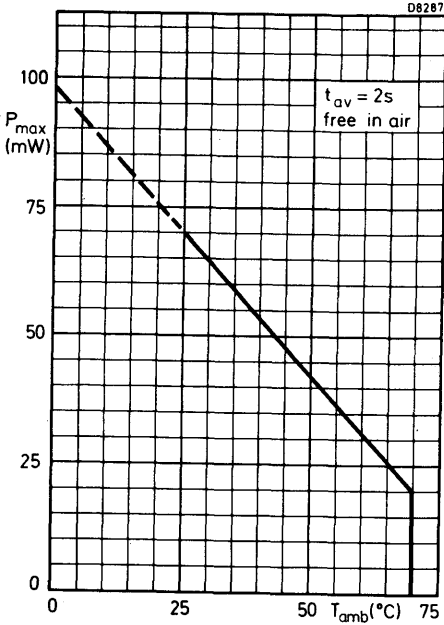

Typical power dissipation as a function of ambient temperature

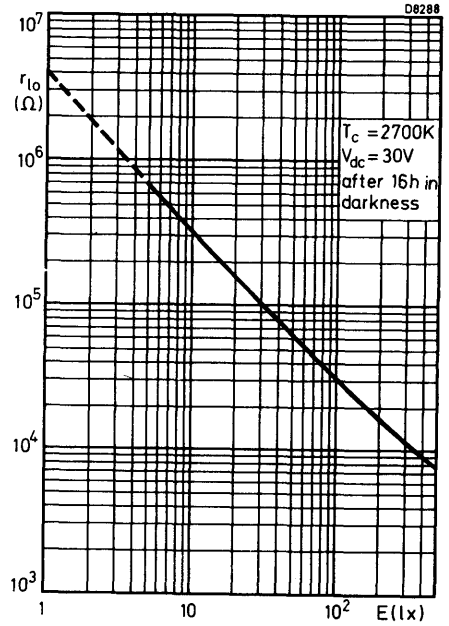

Typical cell resistance as a function of illumination



## CADMIUM SULPHIDE PHOTOCONDUCTIVE CELL

Side sensitive cadmium sulphide photoconductive cell in hermetically sealed glass envelope intended for applications such as flame failure circuits and for automatic brightness and contrast controls in television receivers.

### QUICK REFERENCE DATA

Power dissipation at $T_{amb} = 25\text{ }^{\circ}\text{C}$	P	max.	70	mW
Cell voltage, d.c. and repetitive peak	V	max.	350	V
Cell resistance at 50 lx, 2700 K colour temperature	$r_{lo}$	typ.	60	k $\Omega$

This data must be read in conjunction with GENERAL SAFETY RECOMMENDATIONS—OPTOELECTRONIC DEVICES

### MECHANICAL DATA

Dimensions in mm

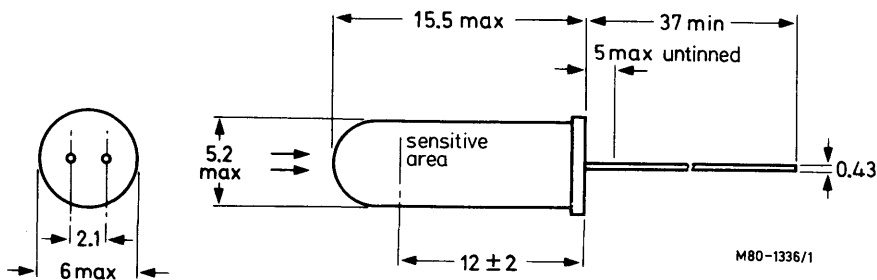

### POTENTIAL HAZARD – CADMIUM COMPOUND

Cadmium compounds are toxic. In the event of accidental breakage, cadmium dust may be released. Gloves should be worn and the dust should be mopped up with a damp cloth. Upon disposal, the cloth should be sealed in a plastic bag and the hands washed thoroughly with soap and water. Controlled disposal of devices containing cadmium compounds should be conducted in the open air or in a well ventilated area.

Inhalation of cadmium dust must be avoided.

This potential hazard is present, if breakage occurs, at all times from receipt to disposal of devices which should therefore be carried out in accordance with the Deposit of Poisonous Waste Act 1972 and the Control of Pollution Act 1974, or with the latest legislation.



**Soldering**

The cell may be soldered directly into the circuit but heat conducted to the tablet should be kept to a minimum by the use of a thermal shunt. The cell may be desoldered at a solder temperature of 240 °C for maximum 10 s up to a point 5 mm from the seals.

**ELECTRICAL DATA**

**General**

The electrical properties of CdS cells are dependent upon many factors such as illumination, colour temperature of the light source, voltage, current, temperature, total time of operation and period of operation during the last 24 hours prior to measurement. The following basic characteristics are therefore only test points for the electrical properties of these devices.

**Basic characteristics at  $T_{amb} = 25\text{ °C}$ ; illumination colour temperature 2700 K.**

Initial dark resistance measured at 300 V d.c. applied via 1 M $\Omega$ , 20 s after switching off the illumination	$r_{do}$	min.	200	M $\Omega$ <sup>1)</sup>
Initial illumination resistance measured at 30 V d.c. illumination = 50 lx, after 16 hrs in darkness <sup>2)</sup>	$r_{lo}$	min.	37.5	k $\Omega$
		typ.	60	k $\Omega$
		max.	150	k $\Omega$
Equilibrium illumination resistance measured at 30 V d.c. illumination = 50 lx after 15 min under the measuring conditions	$r_{le}$	min.	37.5	k $\Omega$
		typ.	75	k $\Omega$
		max.	190	k $\Omega$
Negative temperature response of illumination resistance		typ.	0.2	%/°C
		max.	0.5	%/°C
Voltage response	$\frac{r \text{ at } 0.5 \text{ V d.c.}}{r \text{ at } 30 \text{ V d.c.}}$	$\alpha$	typ.	1.5

1) The spread of the dark resistance is large and values higher than 1000 M $\Omega$  are possible for the initial dark resistance.

2) After 16 hours in darkness changes in the CdS material are still occurring but have insignificant effect on the illumination resistance.





**RATINGS** Limiting values in accordance with the Absolute Maximum System (IEC134)

Cell voltage, d.c. and repetitive peak	V	max.	350	V
Cell voltage, pulse, $t_p \leq 5$ ms, $P_{rr} \leq$ once per minute	$V_M$	max.	500	V
Power dissipation ( $t_{av} = 2$ s) see graph $P_{max}$				
Power dissipation, pulsed	$P_M$	max.	$5 \times P_{max}$	
Illumination	E	max.	50 000	lx
Temperature CdS tablet, operating	$T_{tablet}$	max.	85	$^{\circ}C$
Ambient temperature, storage and operation	$T_{amb}$	min.	-40	$^{\circ}C$
storage	$T_{stg}$	max.	50	$^{\circ}C$ 1)
operating	$T_{amb}$	max.	70	$^{\circ}C$

**DESIGN CONSIDERATIONS**

Apparatus with CdS cells should be designed so that changes in illumination resistance of the cells during life, underrated load from -50% to 100% (typ. +50%) do not impair the circuit performance. Direct irradiation by sunlight should be avoided.

**RUGGEDNESS**

More than 95% of production passes the following shock and vibration tests.

**Shock**

25  $g_{peak}$  3000 shocks in each of the three positions of the cell.

**Vibration**

2.5  $g_{peak}$  50 Hz, during 32 hours in each of the three positions of the cell.

- 1) Operation of the cell counteracts the deteriorating effect of long periods at high temperature. The maximum operating temperature is therefore higher than the maximum storage temperature.



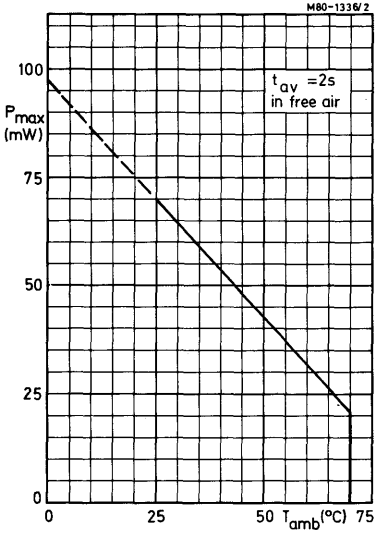

Typical power dissipation as a function of ambient temperature

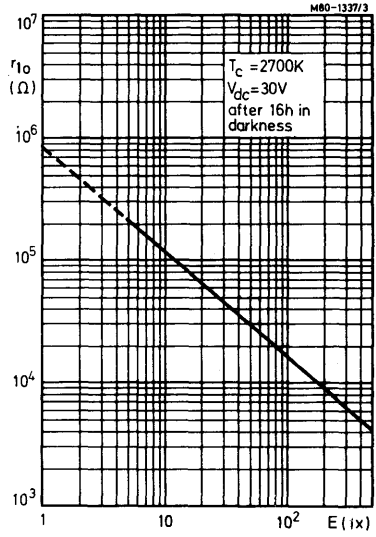

Typical cell resistance as a function of illumination.



## CADMIUM SULPHIDE PHOTOCONDUCTIVE CELL

Cadmium sulphide photoconductive cell for end or side illumination. It is intended for use in industrial applications such as flame failure circuits, obscurity switches and for automatic brightness and contrast controls in television receivers.

The cell is in a hermetically sealed glass envelope and is tropicalized.

### QUICK REFERENCE DATA

Power dissipation at $T_{amb} = 25\text{ }^{\circ}\text{C}$	P	max.	100	mW
Cell voltage, d.c. or r.m.s. value	V	max.	350	V
Cell resistance at 50 lx, colour temperature 2700 K	$r_{lo}$	typ.	30	k $\Omega$
Spectral sensitivity	$\lambda_{peak}$	max.	$575 \pm 50$	nm
Spectral response (90% decrease in sensitivity)		min.	400	nm
		max.	850	nm
Element dimensions			1 x 2	mm

This data must be read in conjunction with GENERAL SAFETY RECOMMENDATIONS – OPTOELECTRONIC DEVICES

### MECHANICAL DATA

Dimensions in mm

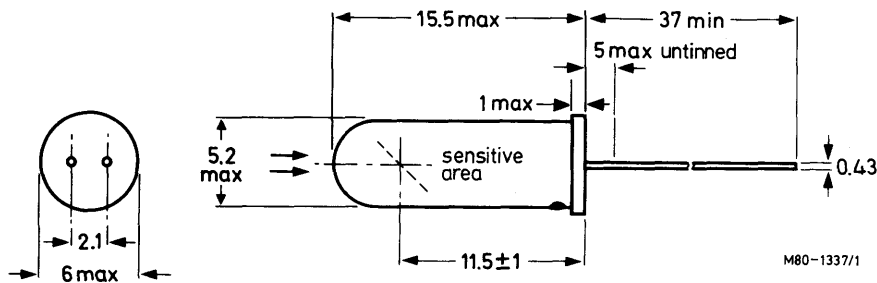

1) Coloured dot indicates light sensitive side.

### POTENTIAL HAZARD – CADMIUM COMPOUND

Cadmium compounds are toxic. In the event of accidental breakage, cadmium dust may be released. Gloves should be worn and the dust should be mopped up with a damp cloth. Upon disposal, the cloth should be sealed in a plastic bag and the hands washed thoroughly with soap and water. Controlled disposal of devices containing cadmium compounds should be conducted in the open air or in a well ventilated area.

Inhalation of cadmium dust must be avoided.

This potential hazard is present, if breakage occurs, at all times from receipt to disposal of devices which should therefore be carried out in accordance with the Deposit of Poisonous Waste Act 1972 and the Control of Pollution Act 1974, or with the latest legislation.

**Soldering**

The cell may be soldered directly into the circuit, but a heatsink must be used between the soldering point and the cell to avoid overheating. The soldering point must be at least 5 mm from the case. The device may be dip-soldered at a solder temperature of 240 °C for a maximum of 10 s. The leads must not be bent at less than 1.5 mm from the case.

**GENERAL**

The electrical properties of CdS cells depend on many factors, such as illumination, colour temperature of the light source, voltage, current, ambient temperature, total time of operation and period of operation during the 24 hours prior to measurement.

**CHARACTERISTICS**

( $T_{amb} = 25\text{ }^{\circ}\text{C}$ , illumination colour temperature 2700 K)

Initial dark resistance measured with 300 V d.c. supply, 20 s after the illumination is removed, note 1	$r_{do}$	min.	100	MΩ
Initial illumination resistance measured with 30 V d.c. supply; illumination = 50 lx, after 16 h in darkness	notes 2, 3 $r_{lo}$	min. typ. max.	20 30 60	kΩ kΩ kΩ
Equilibrium illumination resistance measured with 30 V d.c. supply, after 15 minutes operation at 50 lx	$r_{le}$	min. typ. max.	27 46 115	kΩ kΩ kΩ
Voltage response $\frac{r \text{ at } 0.5 \text{ V}_{dc}}{r \text{ at } 30 \text{ V}_{dc}}$	$\alpha$	typ.	1.4	
Negative temperature response of illumination resistance		typ. max.	0.2 0.5	%/°C %/°C

**NOTES**

1. The spread of dark resistance is large and values higher than 1000 MΩ are possible.
2. After 16 h in darkness, changes in the CdS material are still taking place, but have an insignificant effect on the illumination resistance.
3. Measured with end-on illumination.



**RATINGS** Limiting values in accordance with the Absolute Maximum System (IEC 134)

Cell voltage d.c. or r.m.s. value	V	max.	350	V
Cell voltage, pulsed, $t_p \leq 5$ ms, pulse repetition rate $\leq$ once per minute	$V_M$	max.	700	V
Power dissipation ( $t_{av} = 2$ s) at $T_{amb} = \leq 25$ °C	$P_M$	max.	100	mW
Power dissipation, pulsed	$P_M$	max.	1	W
Cell temperature	$T_{cell}$	max.	+85	°C
Ambient temperature for operation	$T_{amb}$	min.	-40	°C
		max.	+70	°C
Ambient temperature for storage	$T_{stg}$	min.	-40	°C
		max.	+50	°C*

**RUGGEDNESS**

The following test conditions characterize the shock and vibration resistance of the cell; they must not be considered as operating conditions.

The cell will withstand 10 000 shocks of 25 G in one of the three major axes as well as 32 hours of vibration of 2.5 G at 50 Hz in three different directions.

\*Operation of the cell counteracts the deteriorating effect of long periods at high temperature. The maximum operating temperature is therefore higher than the maximum storage temperature.



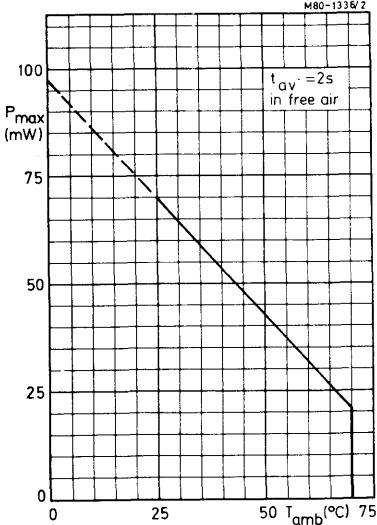

Typical power dissipation as a function of ambient temperature

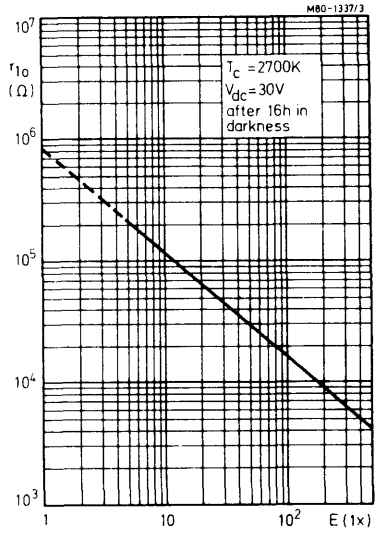

Typical cell resistance as a function of illumination



## CADMIUM SULPHIDE PHOTOCONDUCTIVE CELL

Side sensitive cadmium sulphide photoconductive cell in a plastic encapsulation.  
The device consists of two cells connected in series and is intended for general applications.

### QUICK REFERENCE DATA

Power dissipation at $T_{amb} \leq 25 \text{ }^\circ\text{C}$	P	100	mW
Voltage, d.c. and repetitive peak	V	max. 50	V
Resistance at 50 lux, $T_C = 2700 \text{ }^\circ\text{K}$	$r_{lo}$	600	$\Omega$
Wavelengths at 50% sensitivity	$\lambda$	500 and 675	nm
Outline dimensions	max.	5.3 x 5.3 x 1.4	mm

This data must be read in conjunction with GENERAL SAFETY RECOMMENDATIONS – OPTOELECTRONIC DEVICES

### MECHANICAL DATA

Dimensions in mm

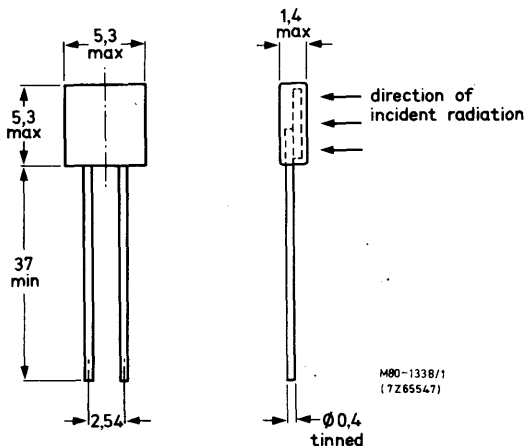

### POTENTIAL HAZARD – CADMIUM COMPOUND

Cadmium compounds are toxic. In the event of accidental breakage, cadmium dust may be released. Gloves should be worn and the dust should be mopped up with a damp cloth. Upon disposal, the cloth should be sealed in a plastic bag and the hands washed thoroughly with soap and water. Controlled disposal of devices containing cadmium compounds should be conducted in the open air or in a well ventilated area.

Inhalation of cadmium dust must be avoided.

This potential hazard is present, if breakage occurs, at all times from receipt to disposal of devices which should therefore be carried out in accordance with the Deposit of Poisonous Waste Act 1972 and the Control of Pollution Act 1974, or with the latest legislation.



**Soldering**

The device may be soldered direct into the circuit but heat conducted to the tablet should be kept to a minimum by the use of a thermal shunt.  
It may be dip-soldered at a solder temperature of 270 °C for a maximum of 2 s up to a point 6 mm from the envelope.

**RATINGS** Limiting values in accordance with the Absolute Maximum System (IEC134)

Cell voltage, d.c. and repetitive peak	V	max.	50	V
Cell voltage, $P_{rr} \leq$ once per minute, $t_p \leq 5$ ms	$V_M$	max.	100	V
Power dissipation, $t_{av} = 0.5$ s, $T_{amb} \leq 25$ °C	P	max.	100	mW
Cell current, d.c. and repetitive peak	I	max.	25	mA
Ambient temperature, storage and operating storage	$T_{amb}$	min.	-40	°C
	$T_{stg}$	max.	+50	°C
Temperature of CdS tablet	$T_{tablet}$	max.	+70	°C

**THERMAL RESISTANCE**

Thermal resistance from CdS tablet to ambient	$R_{th\ t-a}$	=	0.45	°C/mW
---	---------------	---	------	-------

**CHARACTERISTICS**

Initial dark resistance, measured with 50 V d.c. applied via 1 M $\Omega$ , 20 s after switching off the illumination	$r_{do}$	>	200	k $\Omega$
---	----------	---	-----	------------

Initial illumination resistance measured at 1 V d.c., illumination 50 lx, $T_c = 2700$ K	$r_{lo}$	typ.	0.6	k $\Omega$
			0.35-1.4	k $\Omega$

Initial drift	$D_o$	typ.	0	%
---------------	-------	------	---	---

$F_{4700} (= \frac{r_i \text{ at } 4700 \text{ K}}{r_i \text{ at } 2856 \text{ K}})$  at constant illumination and using a Davis-Gibson filter) typ. 1.2

**OPERATING NOTES**

1. The device consists of two photoconductive cells connected in series. The resistance of the device is mainly governed by the resistance of that cell receiving the lower luminous flux.  
If it is required for any application that the device is partly shaded, the shadow line should be perpendicular to the axis of the device.
2. For optimum heat dissipation use the shortest permissible lead length.





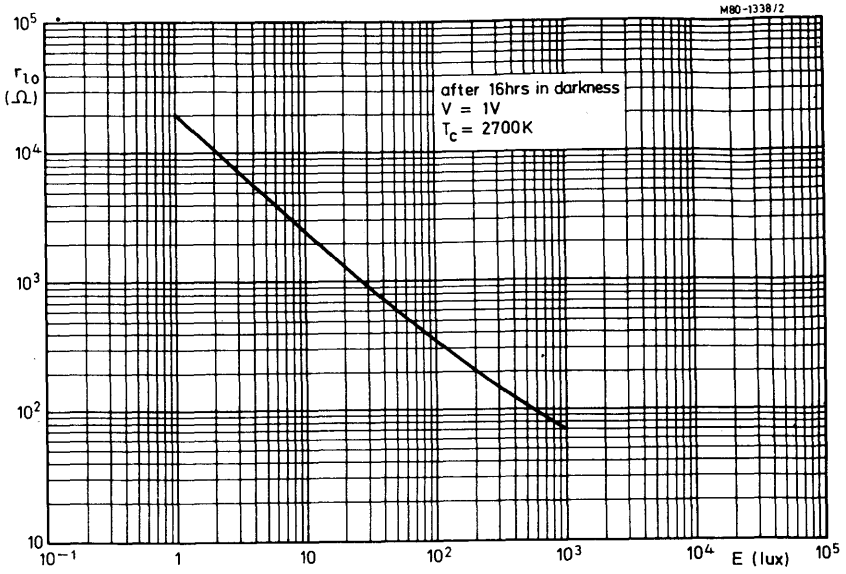

Typical cell resistance as a function of illumination



M80-1338/3 7Z10004

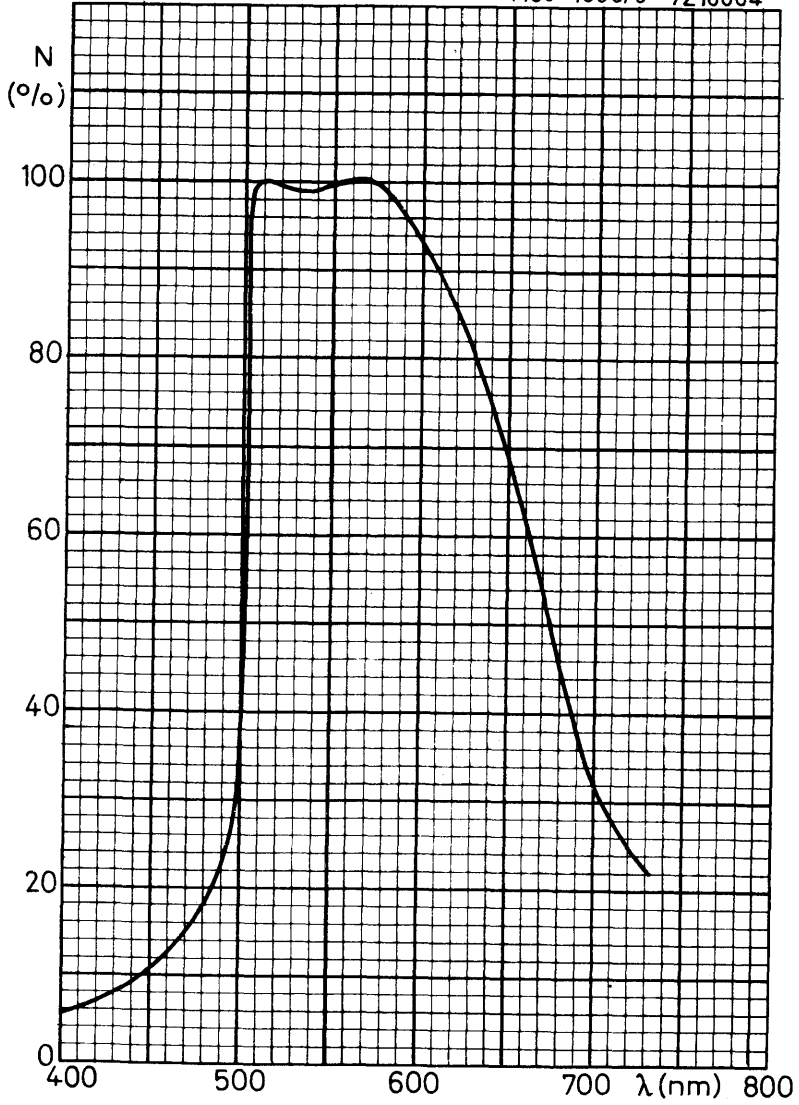

Typical relative spectral response



# PHOTOCOUPLERS

CNX21  
CNX35,6  
CNX38  
CNY50  
CNY62,3

H 



**H**

## DEVELOPMENT SAMPLE DATA

This information is derived from development samples made available for evaluation. It does not necessarily imply that the device will go into regular production.

CNX21

# HIGH-VOLTAGE PHOTOCOUPLER

Optically coupled isolator consisting of an infrared emitting GaAs diode and a silicon n-p-n photo-transistor without accessible base.

Features of this product:

- very high isolation voltage of 10 kV (d.c.).
- working voltage of 10 kV (d.c.).

### QUICK REFERENCE DATA

#### Diode

Continuous reverse voltage	$V_R$	max.	5 V
Forward current			
d.c.	$I_F$	max.	100 mA
(peak value); $t_p = 10 \mu s$ ; $\delta = 0,1$	$I_{FM}$	max.	1000 mA
Total power dissipation up to $T_{amb} = 25 \text{ }^\circ\text{C}$	$P_{tot}$	max.	100 mW

#### Transistor

Collector-emitter voltage (open base)	$V_{CEO}$	max.	30 V
Total power dissipation up to $T_{amb} = 25 \text{ }^\circ\text{C}$	$P_{tot}$	max.	100 mW

#### Photocoupler

Output/input d.c. current transfer ratio $I_F = 10 \text{ mA}$ ; $V_{CE} = 0,4 \text{ V}$ ; ( $I_B = 0$ )	$I_C/I_F$	>	0,2
Collector cut-off current (dark) $V_{CC} = 10 \text{ V}$ ; working voltage (d.c.) = 10 kV diode: $I_F = 0$ (see also Fig. 4)	$I_{CEW}$	<	200 nA
Isolation voltage (d.c.)	$V_{IO}$	max.	10 kV

This data must be read in conjunction with GENERAL SAFETY RECOMMENDATIONS – OPTOELECTRONIC DEVICES

### PRODUCT SAFETY

Modern high technology materials have been used in the manufacture of this device to ensure high performance. Some of these materials are toxic in certain circumstances. Mechanical or electrical damage is unlikely to give rise to any hazard, but toxic vapours may be generated if the device is heated to destruction. Disposal of large quantities should therefore be carried out in accordance with the Deposit of Poisonous Waste Act 1972 and the Control of Pollution Act 1974, or with the latest legislation.



**MECHANICAL DATA**

Fig. 1 SOT-91B.

Dimensions in mm

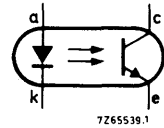
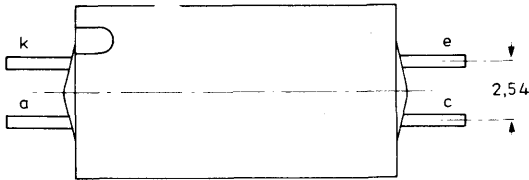
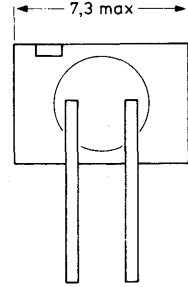
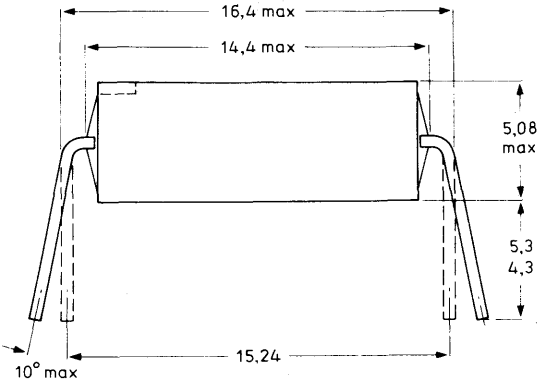

**RATINGS**

Limiting values in accordance with the Absolute Maximum System (IEC 134)

**Diode**

Continuous reverse voltage	$V_R$	max.	5 V
Forward current	$I_F$	max.	100 mA
d.c.	$I_{FM}$	max.	1000 mA
(peak value); $t_p = 10 \mu s$ ; $\delta = 0,1$	$P_{tot}$	max.	100 mW
Total power dissipation up to $T_{amb} = 25 \text{ }^\circ\text{C}$			

**Transistor**

Collector-emitter voltage (open base)	$V_{CEO}$	max.	30 V
Emitter-collector voltage (open base)	$V_{ECO}$	max.	7 V
Collector current	$I_C$	max.	25 mA
d.c.	$I_{CM}$	max.	50 mA
peak value	$P_{tot}$	max.	100 mW
Total power dissipation up to $T_{amb} = 25 \text{ }^\circ\text{C}$			



**Photocoupler**

Storage temperature	$T_{stg}$	-55 to + 100 °C
Junction temperature	$T_j$	max. 100 °C
Lead soldering temperature up to the seating plane; $t_{sld} < 10$ s	$T_{sld}$	max. 260 °C

**THERMAL RESISTANCE**

From junction to ambient in free air diode	$R_{th j-a}$	=	750 °C/W
transistor	$R_{th j-a}$	=	750 °C/W

**CHARACTERISTICS**

$T_j = 25$  °C unless otherwise specified

**Diode**

Forward voltage $I_F = 10$ mA	$V_F$	typ.	1,2 V
		<	1,5 V

Reverse current $V_R = 5$ V	$I_R$	<	100 $\mu$ A
--------------------------------	-------	---	-------------

**Transistor**

Collector cut-off current (dark) $V_{CE} = 10$ V	$I_{CEO}$	typ.	5 nA
		<	50 nA

**Photocoupler ( $I_B = 0$ )\***

Output/input d.c. current transfer ratio $I_F = 10$ mA; $V_{CE} = 0,4$ V	$I_C/I_F$	>	0,2
---	-----------	---	-----

Collector-emitter saturation voltage $I_F = 10$ mA; $I_C = 2$ mA	$V_{CEsat}$	typ.	0,4 V
---	-------------	------	-------

Isolation voltage, d.c. value	$V_{IO}$	max.	10 kV
-------------------------------	----------	------	-------

Capacitance between input and output $I_F = 0$ ; $V = 0$ ; $f = 1$ MHz	$C_{io}$	typ.	1 pF
---	----------	------	------

Insulation resistance between input and output $\pm V_{IO} = 1$ kV	$r_{IO}$	>	$10^{11} \Omega$
		typ.	$10^{12} \Omega$

DEVELOPMENT SAMPLE DATA

\* Where the phototransistor receives light from the diode the O (for open base) has been omitted from the symbols.



Switching times (see Figs 2 and 3)

$I_{Con} = 2 \text{ mA}$ ;  $V_{CC} = 20 \text{ V}$ ;  $R_L = 100 \Omega$

Rise time

$t_r$  typ.  $3 \mu\text{s}$

Fall time

$t_f$  typ.  $2.5 \mu\text{s}$

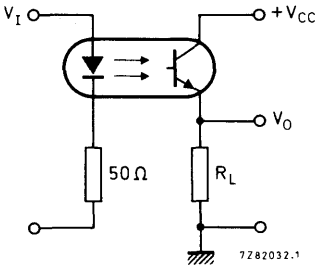

Fig. 2 Switching circuit.

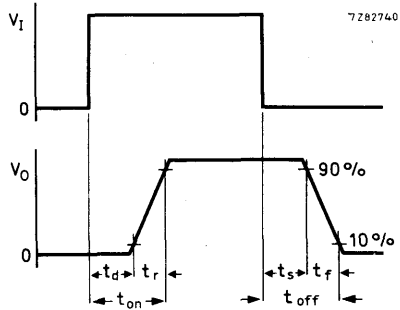

Fig. 3 Waveforms.

Collector cut-off current (dark) see Fig. 4

$V_{CC} = 10 \text{ V}$ ; working voltage (d.c.) =  $10 \text{ kV}$

$I_{CEW} < 200 \text{ nA}^*$

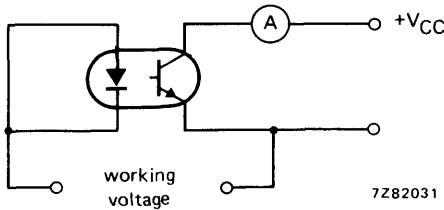

Fig. 4.

\* As quality assurance (on a sample basis), these parameters are covered by a 1000 h reliability test.





DEVELOPMENT SAMPLE DATA

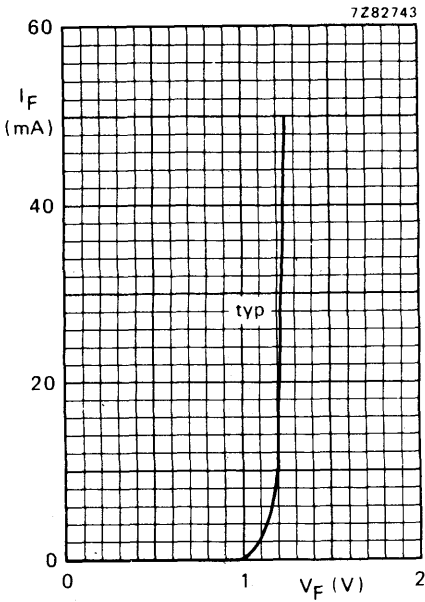

Fig. 5  $T_j = 25\text{ }^\circ\text{C}$ .

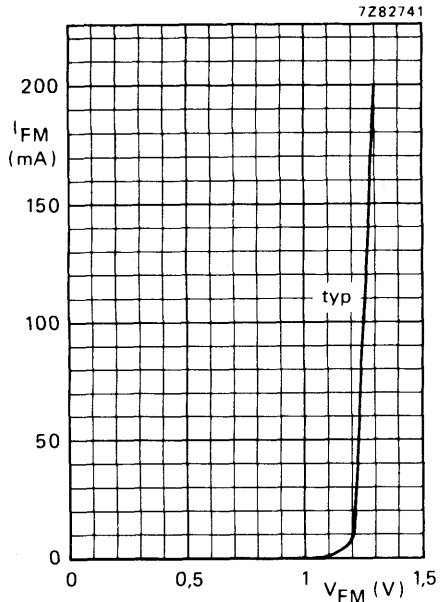

Fig. 6  $T_{\text{amb}} = 25\text{ }^\circ\text{C}$ ;  $t_p = 10\text{ }\mu\text{s}$ ;  $T = 1\text{ ms}$ .

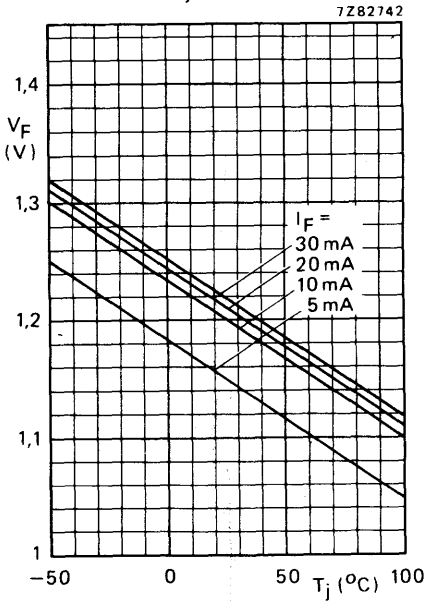

Fig. 7 Typical values.

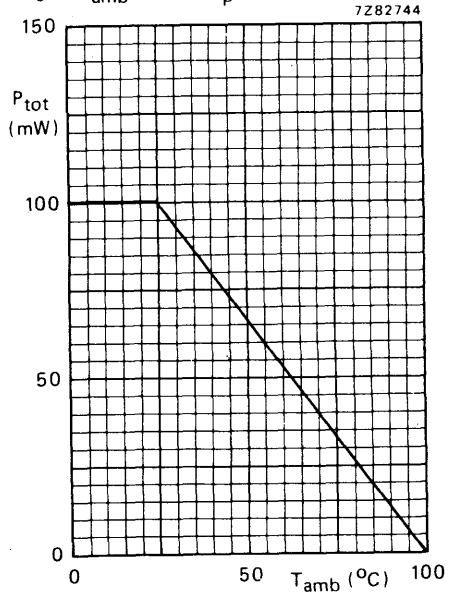

Fig. 8 Power derating curve for diode and transistor versus ambient temperature.



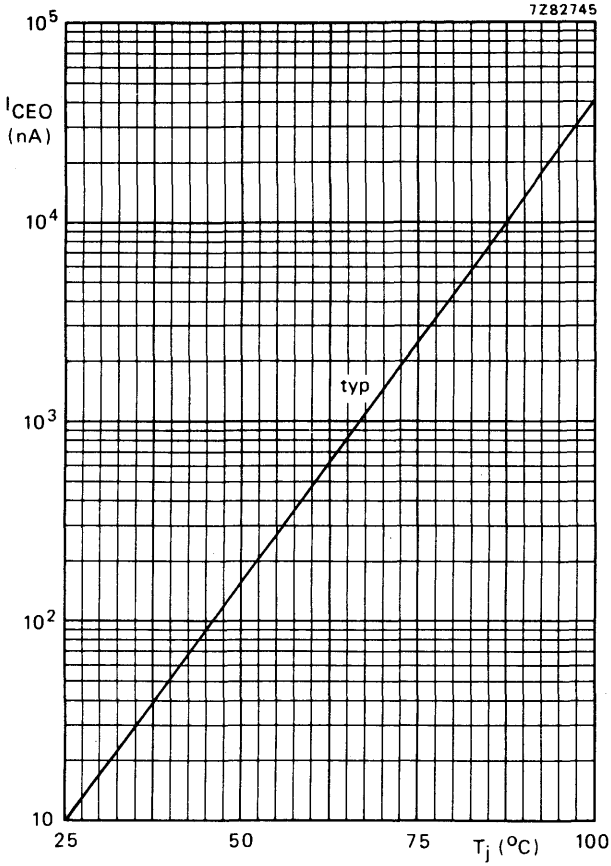

Fig. 9  $I_F = 0$ ;  $V_{CE} = 20$  V.



DEVELOPMENT SAMPLE DATA

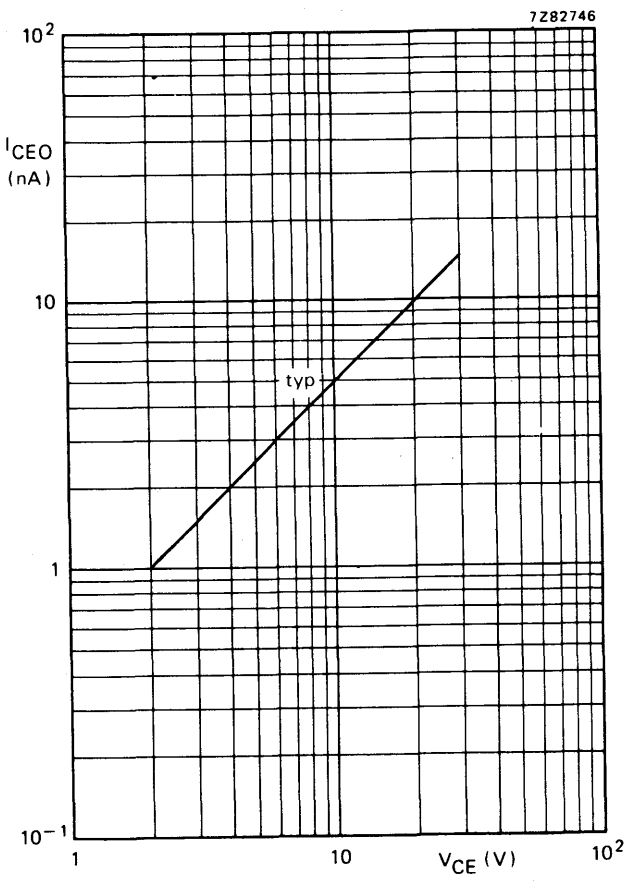

Fig. 10 I<sub>F</sub> = 0; T<sub>j</sub> = 25 °C.



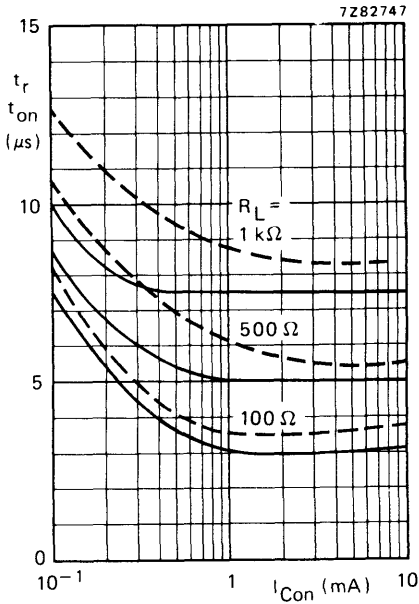

Fig. 11 —  $t_r$ ; ---  $t_{on}$ ;  $I_B = 0$ ;  
 $V_{CC} = 20\ V$ ;  $T_{amb} = 25\ ^\circ C$ ; typical values.  
 See also Fig. 13.

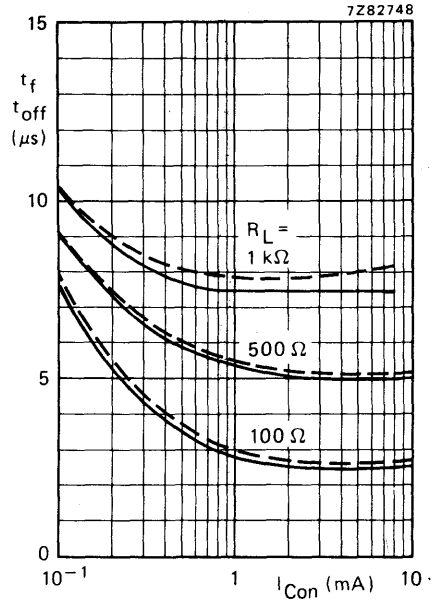

Fig. 12 —  $t_f$ ; ---  $t_{off}$ ;  $I_B = 0$ ;  
 $V_{CC} = 20\ V$ ;  $T_{amb} = 25\ ^\circ C$ ; typical values.  
 See also Fig. 13.

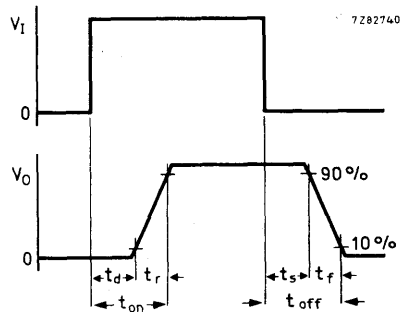
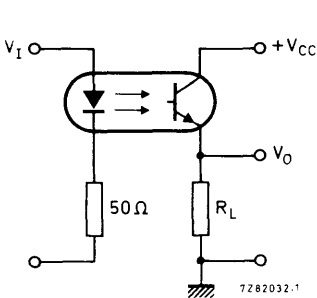

Fig. 13 Switching circuit and waveforms.



## PHOTOCOUPLERS

Optically coupled isolators consisting of an infrared emitting GaAs diode and a silicon n-p-n photo-transistor with accessible base. Plastic envelopes. Suitable for TTL integrated circuits.

Features of these products:

- high output/input d.c. current transfer ratio;
- low saturation voltage;
- high isolation voltage of 3 kV (r.m.s.) and 4,4 kV (d.c.);
- working voltage 1,5 kV.

### QUICK REFERENCE DATA

This data must be read in conjunction with **GENERAL SAFETY RECOMMENDATIONS – OPTOELECTRONIC DEVICES**

#### Diode

Continuous reverse voltage	$V_R$	max.	3 V
Forward current d.c. (peak value); $t_p = 10 \mu s$ ; $\delta = 0,1$	$I_F$ $I_{FM}$	max.	100 mA 3000 mA
Total power dissipation up to $T_{amb} = 25^\circ C$	$P_{tot}$	max.	200 mW

#### Transistor

Collector-emitter voltage (open base)	$V_{CEO}$	max.	30 V
Total power dissipation up to $T_{amb} = 25^\circ C$	$P_{tot}$	max.	200 mW

#### Photocoupler

Output/input d.c. current transfer ratio $I_F = 10 \text{ mA}$ ; $V_{CE} = 0,4 \text{ V}$ ; ( $I_B = 0$ )	CNX35 CNX36	$I_C/I_F$ $I_C/I_F$	> >	0,4 0,8
Collector cut-off current (dark) $V_{CC} = 10 \text{ V}$ ; working voltage (d.c.) = 1,5 kV diode: $I_F = 0$ (see also Fig. 2)		$I_{CEW}$	<	200 nA
Isolation voltage (d.c.) $t = 1 \text{ min}$		$V_{IO}$	max.	4,4 kV

### MECHANICAL DATA

SOT-90 (see page 2)

### PRODUCT SAFETY

Modern high technology materials have been used in the manufacture of this device to ensure high performance. Some of these materials are toxic in certain circumstances. Mechanical or electrical damage is unlikely to give rise to any hazard, but toxic vapours may be generated if the device is heated to destruction. Disposal of large quantities should therefore be carried out in accordance with the Deposit of Poisonous Waste Act 1972 and the Control of Pollution Act 1974, or with the latest legislation.



MECHANICAL DATA

Fig. 1 SOT-90.

Dimensions in mm

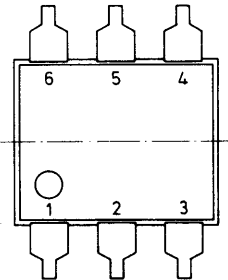
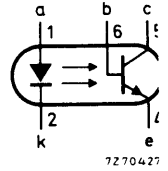
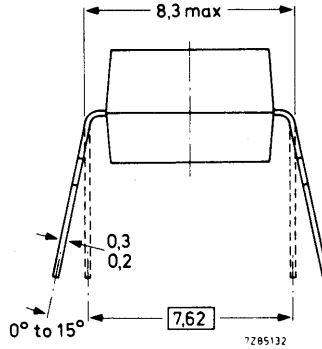
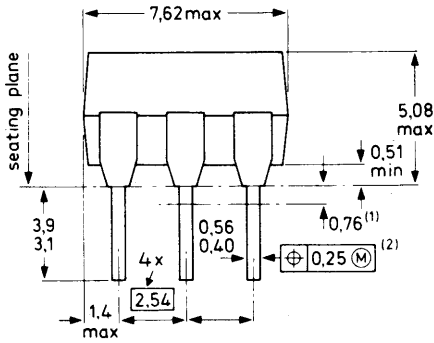

- A Centre lines of all leads are within  $\pm 0,127$  mm of the nominal positions shown: in the worst case, the spacing between adjacent leads may deviate from nominal by  $\pm 0,254$  mm.
- B Tolerances of note A within this distance.
- $\oplus$  Positional accuracy.
- $\textcircled{M}$  Maximum Material Condition.

RATINGS

Limiting values in accordance with the Absolute Maximum System (IEC 134)

Diode

Continuous reverse voltage	$V_R$	max.	3 V
Forward current (d.c.)	$I_F$	max.	100 mA
(peak value); $t_p = 10 \mu s$ ; $\delta = 0,1$	$I_{FM}$	max.	3000 mA
Total power dissipation up to $T_{amb} = 25^\circ C$	$P_{tot}$	max.	200 mW

Transistor

Collector-emitter voltage (open base)	$V_{CEO}$	max.	30 V
Collector-base voltage (open emitter)	$V_{CBO}$	max.	70 V
Emitter-collector voltage (open base)	$V_{ECO}$	max.	7 V
Collector current (d.c.)	$I_C$	max.	100 mA
Total power dissipation up to $T_{amb} = 25^\circ C$	$P_{tot}$	max.	200 mW



**Photocoupler**

Storage temperature	$T_{stg}$	-55 to + 150 °C
Operating junction temperature	$T_j$	max. 125 °C
Lead soldering temperature up to the seating plane; $t_{sld} < 10$ s	$T_{sld}$	max. 260 °C

**THERMAL RESISTANCE**

From junction to ambient in free air diode	$R_{th\ j-a}$	=	500 °C/W
transistor	$R_{th\ j-a}$	=	500 °C/W
From junction to ambient, device mounted on a printed-circuit board diode	$R_{th\ j-a}$	=	400 °C/W
transistor	$R_{th\ j-a}$	=	400 °C/W

**CHARACTERISTICS**

$T_j = 25$  °C unless otherwise specified

**Diode**

Forward voltage $I_F = 10$ mA	$V_F$	typ.	1,15 V
		<	1,5 V
Reverse current $V_R = 3$ V	$I_R$	<	10 µA

**Transistor (diode:  $I_F = 0$ )**

Collector cut-off current (dark) $V_{CE} = 10$ V	$I_{CEO}$	typ.	2 nA
		<	50 nA
$V_{CE} = 10$ V; $T_{amb} = 70$ °C	$I_{CEO}$	<	10 µA
$V_{CB} = 10$ V	$I_{CBO}$	<	20 nA

**Photocoupler ( $I_B = 0$ )\***

Output/input d.c. current transfer ratio $I_F = 10$ mA; $V_{CE} = 5$ V	$I_C/I_F$	typ.	1,5
$I_F = 10$ mA; $V_{CE} = 0,4$ V	CNX35 CNX36	$I_C/I_F$	0,4 to 1,6
		$I_C/I_F$	> 0,8
Collector-emitter saturation voltage $I_F = 10$ mA; $I_C = 2$ mA	$V_{CEsat}$	typ.	0,15 V
$I_F = 10$ mA; $I_C = 4$ mA	$V_{CEsat}$	typ.	0,19 V
Isolation voltage, d.c. value **	$V_{IO}$	max.	4,4 kV

\* Where the phototransistor receives light from the diode the O (for open base) has been omitted from the symbols.

\*\* Tested with a d.c. voltage for 1 minute between shorted input leads and shorted output leads.



CNX35  
CNX36

Collector cut-off current (light) at  $T_{amb} = 0\text{ }^{\circ}\text{C}$  to  $70\text{ }^{\circ}\text{C}$

$V_F = 0,8\text{ V}$ ;  $V_{CE} = 15\text{ V}$

$I_F = 2\text{ mA}$ ;  $V_{CE} = 0,4\text{ V}$

Collector capacitance at  $f = 1\text{ MHz}$

$I_E = I_e = 0$ ;  $V_{CB} = 10\text{ V}$

Capacitance between input and output

$I_F = 0$ ;  $V = 0$ ;  $f = 1\text{ MHz}$

Insulation resistance between input and output

$\pm V_{IO} = 1\text{ kV}$

Switching times (see Figs 2 and 3)

$I_{Con} = 2\text{ mA}$ ;  $V_{CC} = 5\text{ V}$ ;  $R_L = 100\ \Omega$

Turn-on time

Turn-off time

$I_{Con} = 2\text{ mA}$ ;  $V_{CC} = 5\text{ V}$ ;  $R_L = 1\text{ k}\Omega$

Turn-on time

Turn-off time

$I_{CE(L)} < 15\ \mu\text{A}$

$I_{CE(L)} > 150\ \mu\text{A}$

$C_c$  typ.  $4,5\ \mu\text{F}$

$C_{io}$  typ.  $0,6\ \mu\text{F}$

$r_{IO} > 10^{10}\ \Omega$

$r_{IO}$  typ.  $10^{12}\ \Omega$

$t_{on}$  typ.  $3\ \mu\text{s}$

$t_{off}$  typ.  $3\ \mu\text{s}$

$t_{on}$  typ.  $12\ \mu\text{s}$

$t_{off}$  typ.  $12,5\ \mu\text{s}$

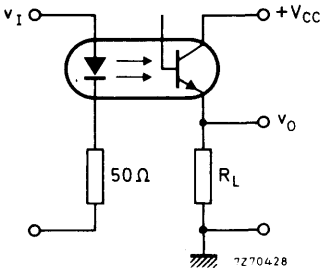
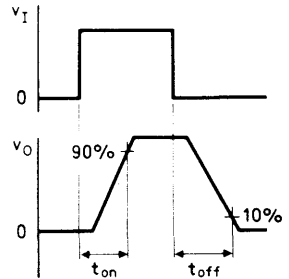

Fig. 2 Switching circuit.



7267238.1

Fig. 3 Waveforms.

Collector cut-off current (dark) see Fig. 4

$V_{CC} = 10\text{ V}$ ; working voltage (d.c.) =  $1,5\text{ kV}$

$V_{CC} = 10\text{ V}$ ; working voltage (d.c.) =  $1,5\text{ kV}$ ;  $T_j = 70\text{ }^{\circ}\text{C}$

$I_{CEW} < 200\ \text{nA}^*$

$I_{CEW} < 100\ \mu\text{A}^*$

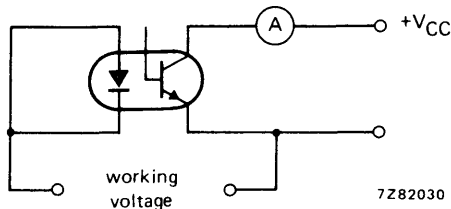

7282030

Fig. 4.

\*As quality assurance (on a sample basis), these parameters are covered by a 1000 h reliability test.





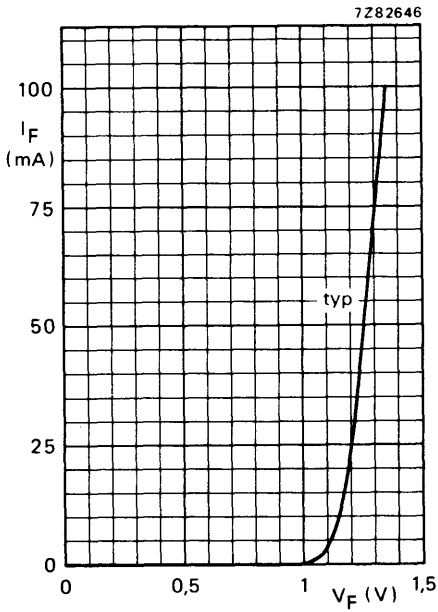

Fig. 5  $T_{amb} = 25\text{ }^{\circ}\text{C}$ .

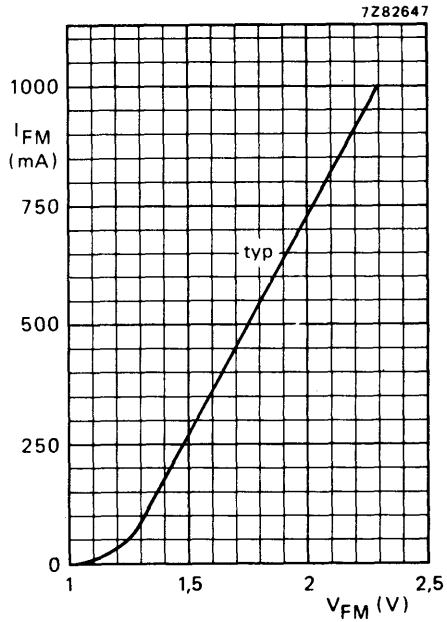

Fig. 6  $T_{amb} = 25\text{ }^{\circ}\text{C}$ ;  $t_p = 10\text{ }\mu\text{s}$ ;  $T = 1\text{ ms}$ .

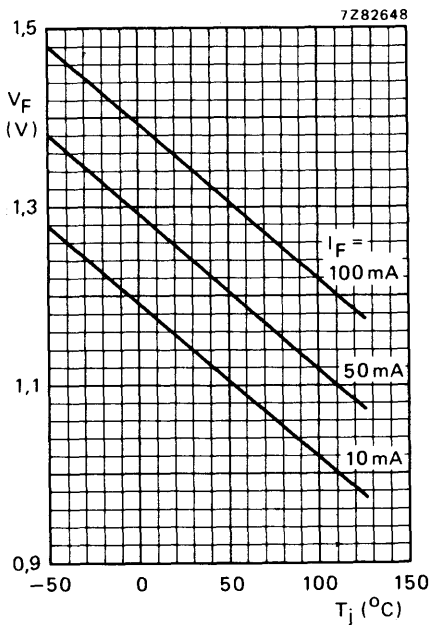

Fig. 7 Typical values.

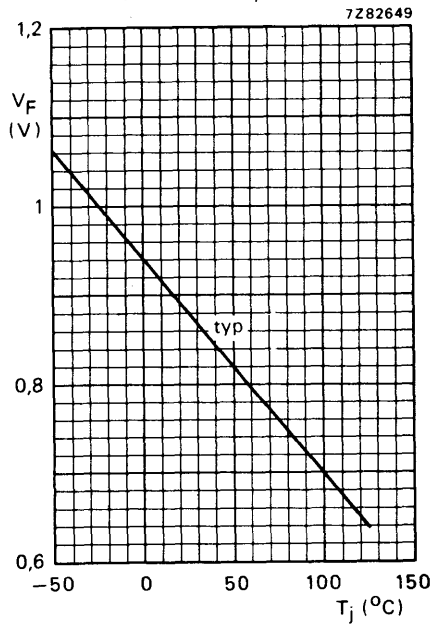

Fig. 8  $I_F = 50\text{ }\mu\text{A}$ .



CNX35  
CNX36

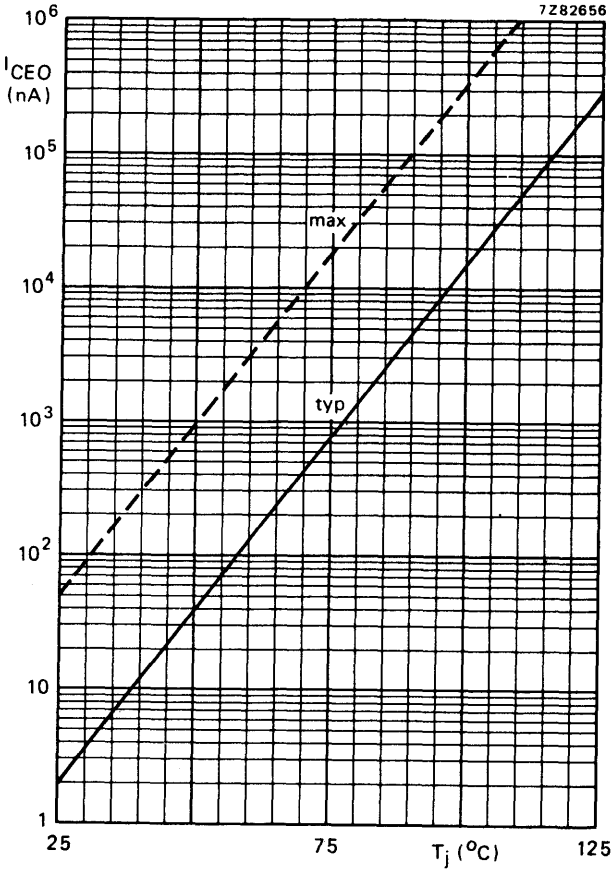

Fig. 9  $I_F = 0$ ;  $V_{CE} = 10$  V.



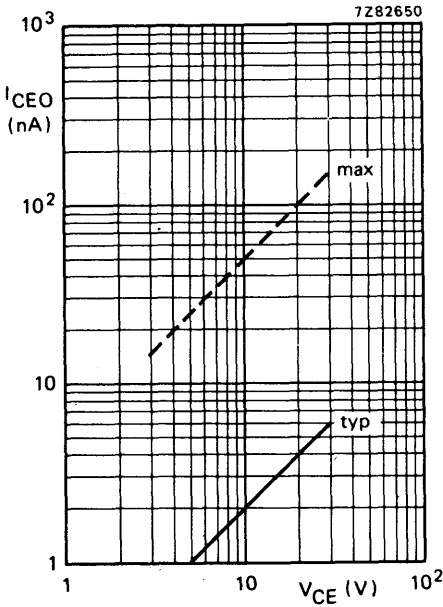

Fig. 10  $I_F = 0$ ;  $T_j = 25^\circ\text{C}$ .

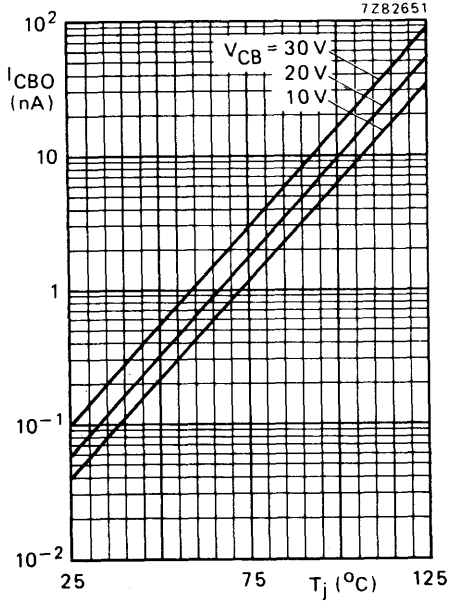

Fig. 11 Typical values.

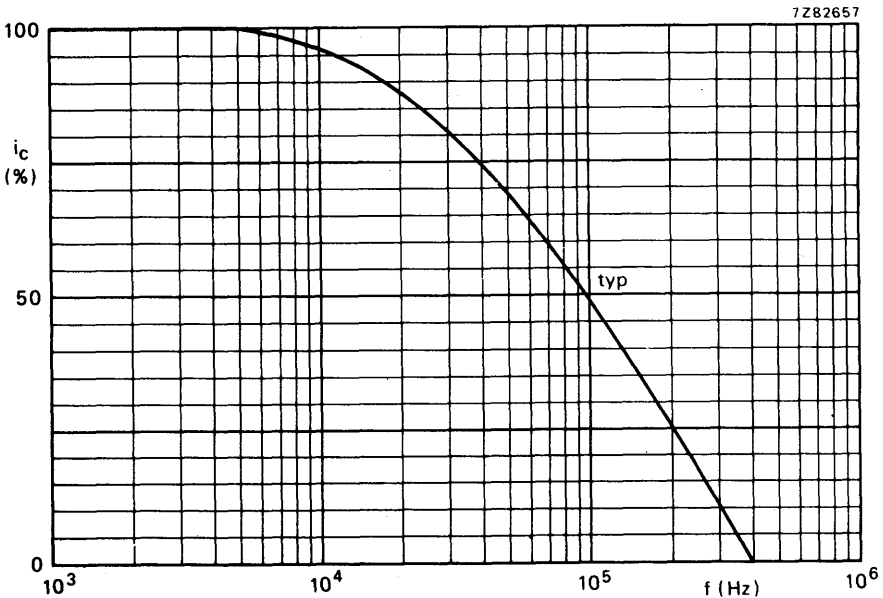

Fig. 12  $I_B = 0$ ;  $I_C = 2\text{mA}$ ;  $V_{CC} = 5\text{V}$ ;  $R_L = 1\text{k}\Omega$ ;  $T_{amb} = 25^\circ\text{C}$ .



CNX35  
CNX36

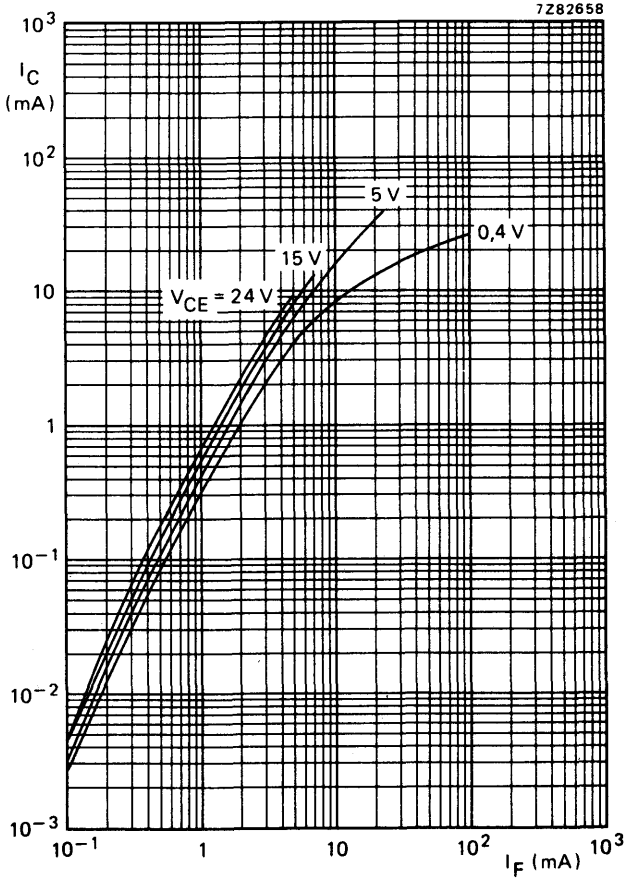

Fig. 13  $T_{amb} = 25^{\circ}C$ , typical values.



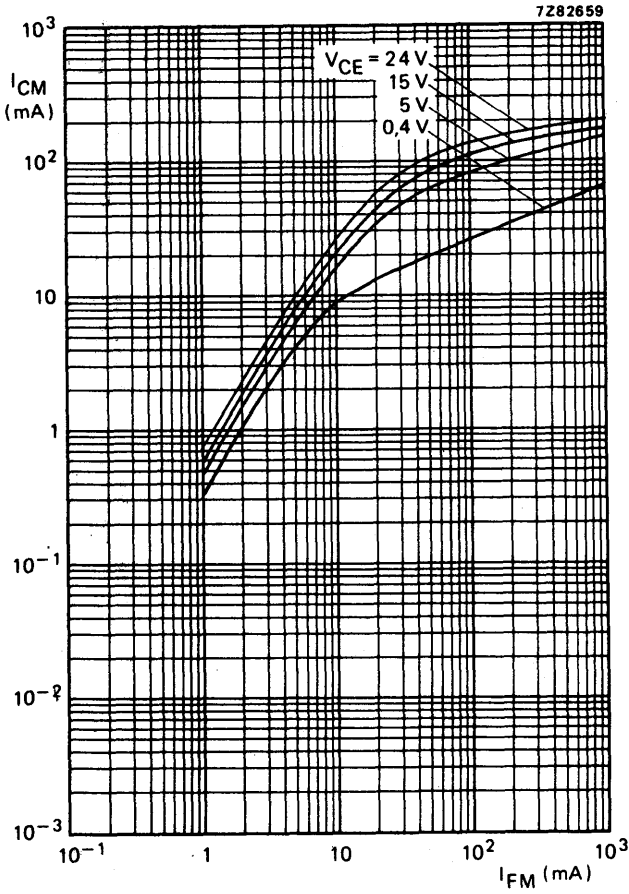

Fig. 14  $T_{amb} = 25$  °C;  $t_p = 10$   $\mu$ s;  $T = 1$  ms; typical values.



CNX35  
CNX36

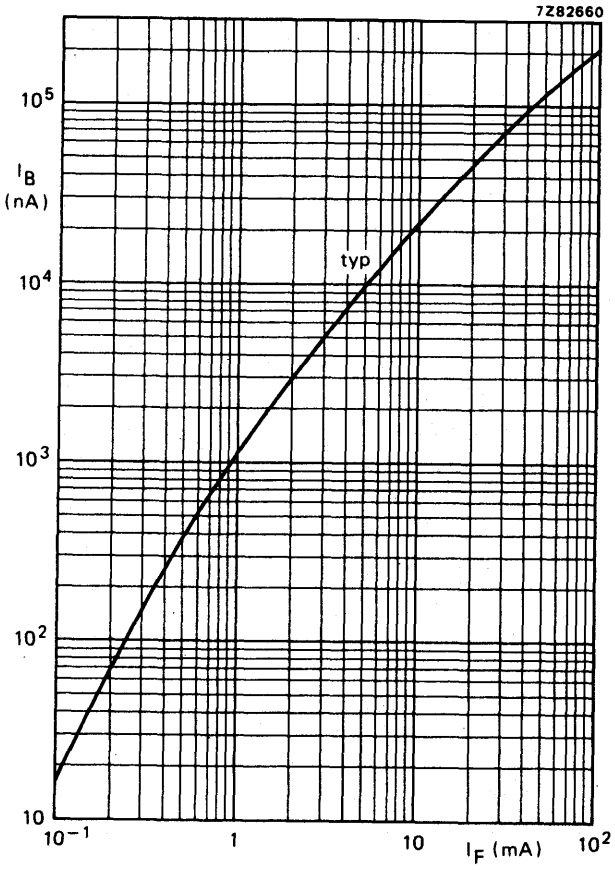

Fig. 15  $V_{CB} = 5\text{ V}$ ;  $T_{amb} = 25\text{ }^\circ\text{C}$ .



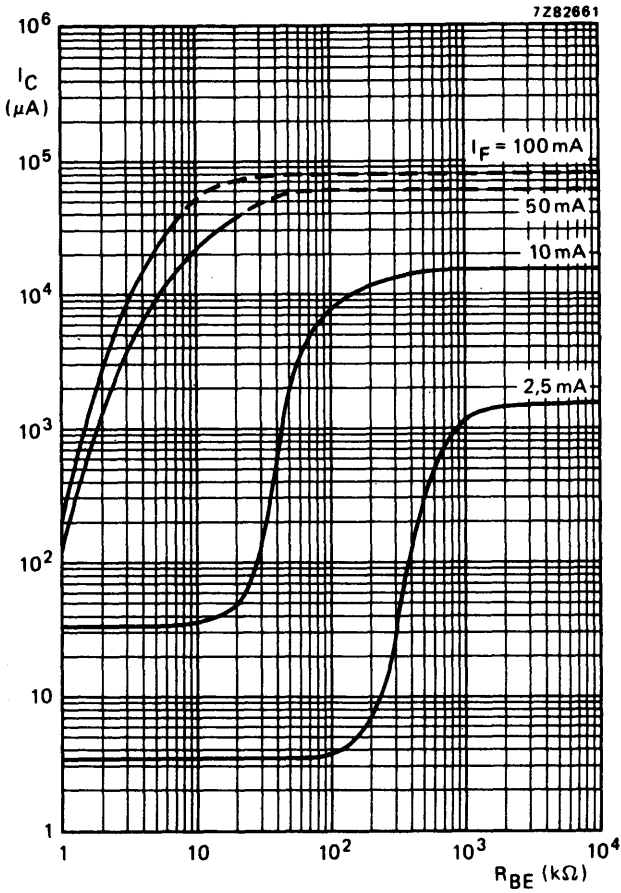

Fig. 16  $I_B = 0$ ;  $V_{CE} = 5\text{ V}$ ;  $T_{amb} = 25\text{ }^\circ\text{C}$ ; typical values.



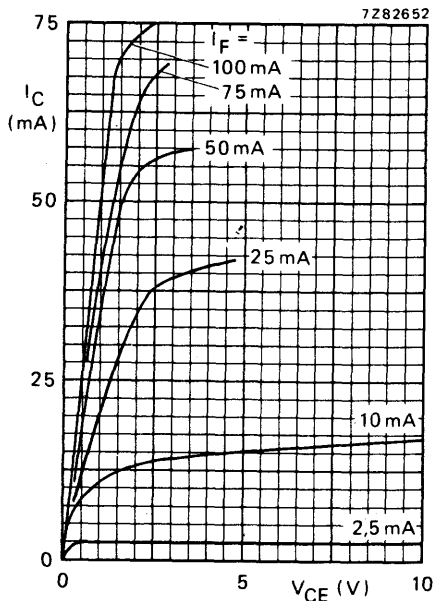

Fig. 17  $T_{amb} = 25^\circ C$ ; typical values.

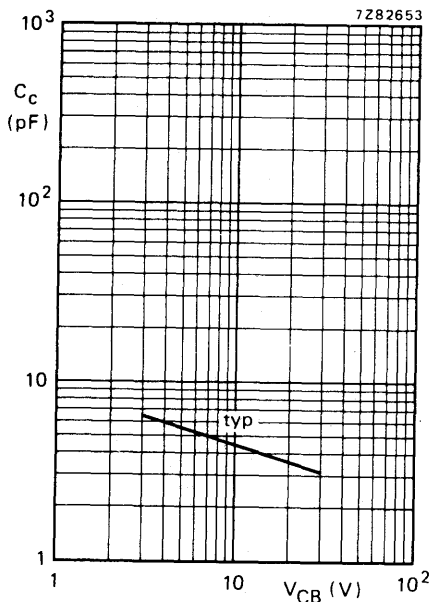

Fig. 18  $f = 1$  MHz;  $T_{amb} = 25^\circ C$ .

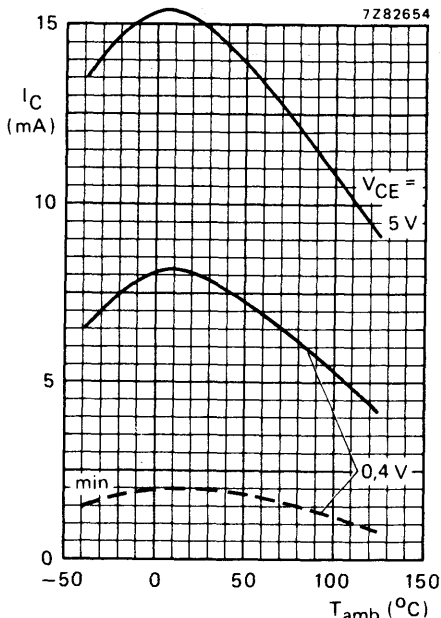

Fig. 19  $I_B = 0$ ;  $I_F = 10$  mA; — typ. values.

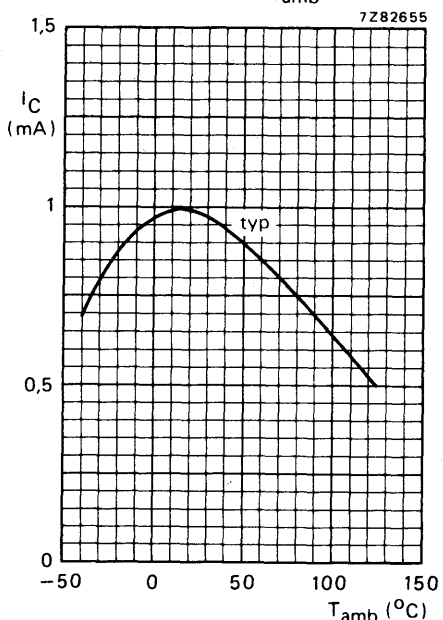

Fig. 20  $I_F = 2$  mA;  $V_{CE} = 0,4$  V.





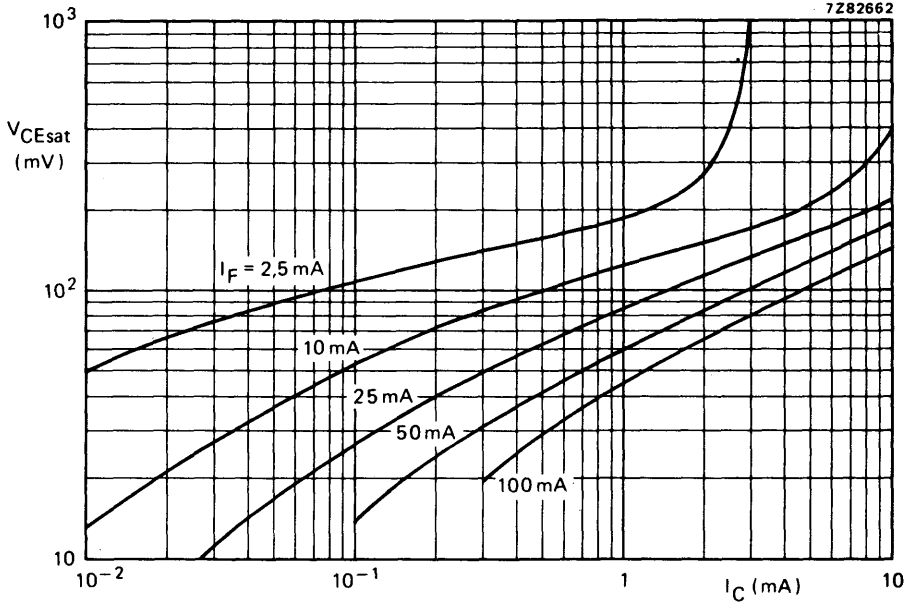

Fig. 21  $I_B = 0$ ;  $T_{amb} = 25^\circ C$ ; typical values.

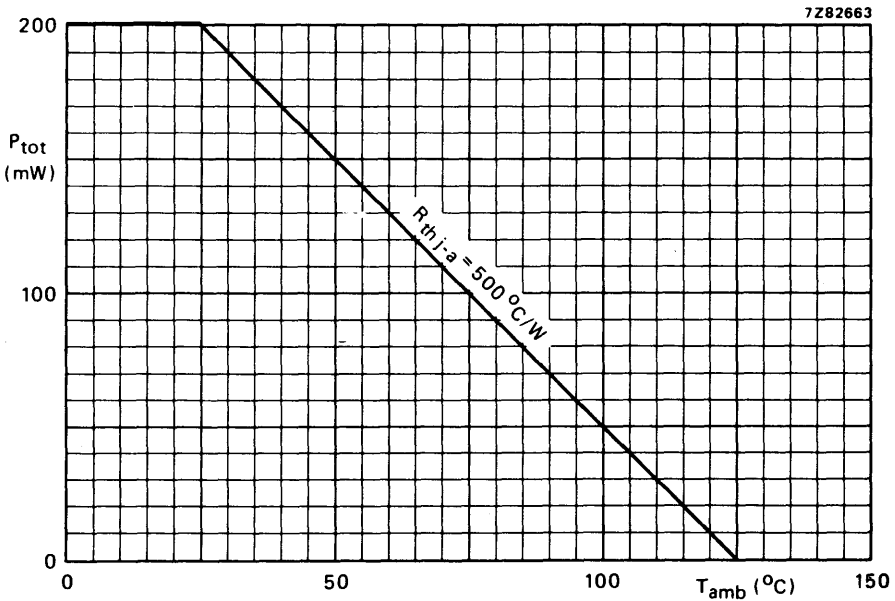

Fig. 22 Max. permissible power dissipation for diode and transistor versus ambient temperature.



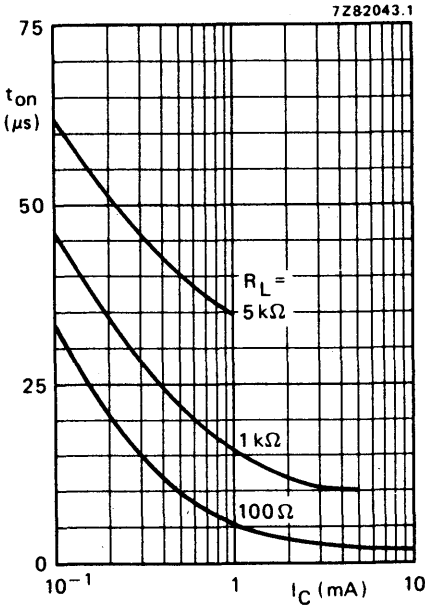

Fig. 23  $I_B = 0$ ;  $V_{CC} = 5 V$ ;  $T_{amb} = 25^\circ C$ ; typical values. (See also Fig. 25.)

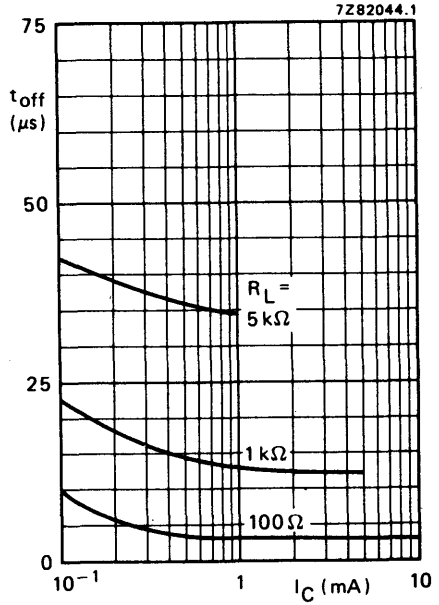

Fig. 24  $I_B = 0$ ;  $V_{CC} = 5 V$ ;  $T_{amb} = 25^\circ C$ ; typical values. (See also Fig. 25.)

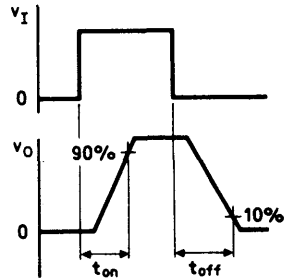
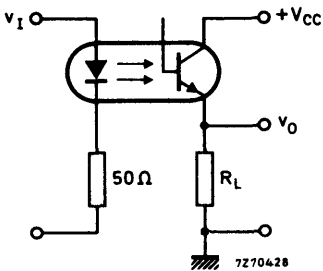

Fig. 25 Switching circuit and waveforms.



## PHOTOCOUPLER

Optically coupled isolator consisting of an infrared emitting GaAs diode and a silicon n-p-n photo-transistor with accessible base. Plastic envelope. Suitable for TTL integrated circuits.

Features of these products:

- high output/input d.c. current transfer ratio;
- low saturation voltage;
- high isolation voltage of 3 kV (r.m.s.) and 4,3 kV (d.c.);
- working voltage 1,5 kV.

## QUICK REFERENCE DATA

## Diode

Continuous reverse voltage	$V_R$	max.	3 V
Forward current d.c. (peak value); $t_p = 10 \mu s$ ; $\delta = 0,1$	$I_F$ $I_{FM}$	max.	100 mA 1000 mA
Total power dissipation up to $T_{amb} = 25 \text{ }^\circ\text{C}$	$P_{tot}$	max.	150 mW

## Transistor

Collector-emitter voltage (open base)	$V_{CEO}$	max.	80 V
Total power dissipation up to $T_{amb} = 25 \text{ }^\circ\text{C}$	$P_{tot}$	max.	200 mW

## Photocoupler

Output/input d.c. current transfer ratio $I_F = 10 \text{ mA}$ ; $V_{CE} = 10 \text{ V}$ ; ( $I_B = 0$ )	$I_C/I_F$		0,7 to 2,1
Collector cut-off current (dark) $V_{CC} = 10 \text{ V}$ ; working voltage (d.c.) = 1,5 kV diode; $I_F = 0$ (see also Fig. 4)	$I_{CEW}$	<	200 nA
Isolation voltage (d.c.) $t = 1 \text{ min}$	$V_{IO}$	max.	4,3 kV

This data must be read in conjunction with GENERAL SAFETY RECOMMENDATIONS – OPTOELECTRONIC DEVICES

## PRODUCT SAFETY

Modern high technology materials have been used in the manufacture of this device to ensure high performance. Some of these materials are toxic in certain circumstances. Mechanical or electrical damage is unlikely to give rise to any hazard, but toxic vapours may be generated if the device is heated to destruction. Disposal of large quantities should therefore be carried out in accordance with the Deposit of Poisonous Waste Act 1972 and the Control of Pollution Act 1974, or with the latest legislation.



MECHANICAL DATA

Dimensions in mm

Fig. 1 SOT-90.

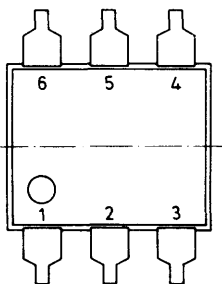
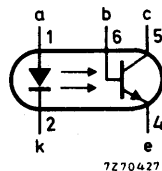
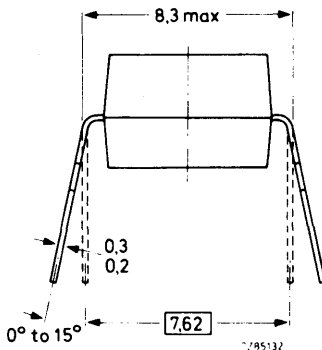
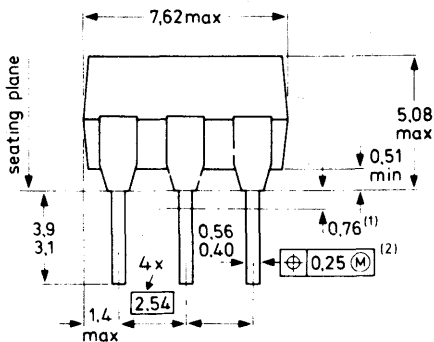

⊕ Positional accuracy.

Ⓜ Maximum Material Condition.

- (1) Lead spacing tolerances apply from seating plane to the line indicated.
- (2) Centre-lines of all leads are within  $\pm 0,125$  mm of the nominal position shown; in the worst case, the spacing between any two leads may deviate from nominal by  $\pm 0,25$  mm.

RATINGS

Limiting values in accordance with the Absolute Maximum System (IEC 134)

Diode

Continuous reverse voltage	$V_R$	max.	3 V
Forward current	$I_F$	max.	100 mA
d.c.	$I_{FM}$	max.	1000 mA
(peak value); $t_p = 10 \mu s$ ; $\delta = 0,1$	$P_{tot}$	max.	150 mW
Total power dissipation up to $T_{amb} = 25 \text{ }^\circ\text{C}$			

Transistor

Collector-base voltage (open emitter)	$V_{CBO}$	max.	120 V
Collector-emitter voltage (open base)	$V_{CEO}$	max.	80 V
Emitter-collector voltage (open base)	$V_{ECO}$	max.	7 V
Collector current (d.c.)	$I_C$	max.	100 mA
Total power dissipation up to $T_{amb} = 25 \text{ }^\circ\text{C}$	$P_{tot}$	max.	200 mW



**Photocoupler**

Storage temperature	$T_{stg}$	-55 to +150 °C
Operating junction temperature	$T_j$	max. 125 °C
Lead soldering temperature up to the seating plane; $t_{sld} < 10$ s	$T_{sld}$	max. 260 °C

**THERMAL RESISTANCE**

From junction to ambient in free air diode	$R_{th\ j-a}$	=	650 °C/W
transistor	$R_{th\ j-a}$	=	500 °C/W
From junction to ambient, device mounted on a printed-circuit board diode	$R_{th\ j-a}$	=	600 °C/W
transistor	$R_{th\ j-a}$	=	400 °C/W

**CHARACTERISTICS**

$T_j = 25$  °C unless otherwise specified

**Diode**

Forward voltage $I_F = 10$ mA	$V_F$	typ. <	1,2 V 1,5 V
Reverse current $V_R = 3$ V	$I_R$	<	10 $\mu$ A

**Transistor (diode:  $I_F = 0$ )**

Collector cut-off current (dark) $V_{CE} = 10$ V	$I_{CEO}$	typ. <	5 nA 50 nA
$V_{CE} = 10$ V; $T_{amb} = 70$ °C	$I_{CEO}$	<	10 $\mu$ A
$V_{CB} = 10$ V; $T_{amb} = 25$ °C	$I_{CBO}$	<	20 nA

**Photocoupler ( $I_B = 0$ ) \***

Output/input d.c. current transfer ratio $I_F = 10$ mA; $V_{CE} = 10$ V	$I_C/I_F$		0,7 to 2,1
$I_F = 16$ mA; $V_{CE} = 0,4$ V	$I_C/I_F$	>	0,5
Collector-emitter saturation voltage $I_F = 16$ mA; $I_C = 2$ mA	$V_{CEsat}$	typ. <	0,2 V 0,4 V
Isolation voltage, d.c. value **	$V_{IO}$	max.	4,3 kV

\* Where the phototransistor receives light from the diode the O (for open base) has been omitted from the symbols.

\*\* Tested with a d.c. voltage for 1 minute between shorted input leads and shorted output leads.



Collector capacitance at  $f = 1 \text{ MHz}$

$I_E = I_e = 0; V_{CB} = 10 \text{ V}$

Capacitance between input and output

$I_F = 0; V = 0; f = 1 \text{ MHz}$

Insulation resistance between input and output

$\pm V_{IO} = 1 \text{ kV}$

Switching times (see Figs 2 and 3)

$I_{Con} = 4 \text{ mA}; V_{CC} = 5 \text{ V}; R_L = 100 \Omega$

Turn-on time

Turn-off time

$C_C$  typ. 6 pF

$C_{io}$  typ. 0,6 pF

$r_{IO} > 10^{10} \Omega$   
typ.  $10^{12} \Omega$

$t_{on}$  typ. 5  $\mu\text{s}$

$t_{off}$  typ. 5  $\mu\text{s}$

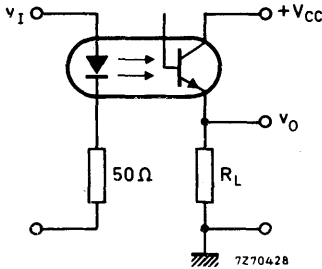

Fig. 2 Switching circuit.

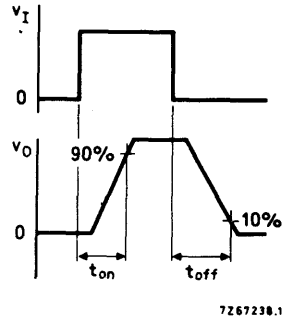

Fig. 3 Waveforms.

Collector cut-off current (dark) see Fig. 4

$V_{CC} = 10 \text{ V};$  working voltage (d.c.) = 1,5 kV

$V_{CC} = 10 \text{ V};$  working voltage (d.c.) = 1,5 kV;  $T_j = 70 \text{ }^\circ\text{C}$

$I_{CEW} < 200 \text{ nA}^*$

$I_{CEW} < 100 \text{ } \mu\text{A}^*$

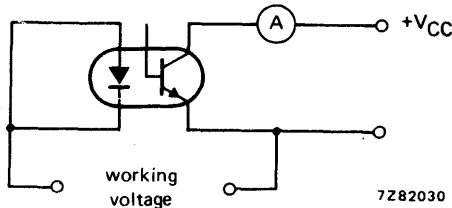

Fig. 4.

\* As quality assurance (on a sample basis), these parameters are covered by a 1000 h reliability test.



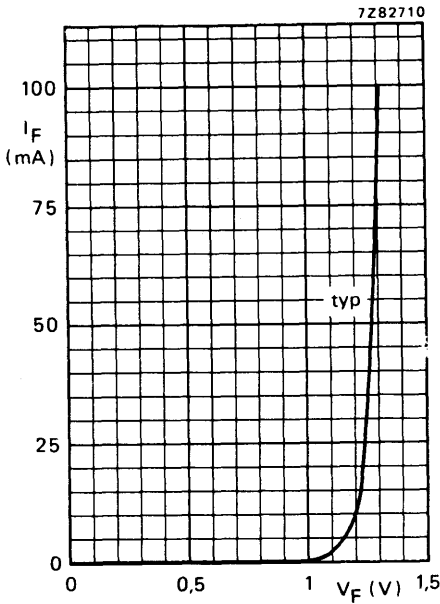

Fig. 5  $T_{amb} = 25^{\circ}C$ .

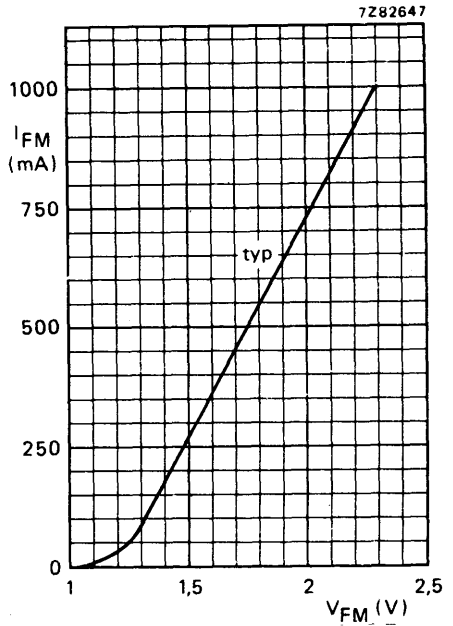

Fig. 6  $T_{amb} = 25^{\circ}C$ ;  $t_p = 10 \mu s$ ;  $T = 1 ms$ .

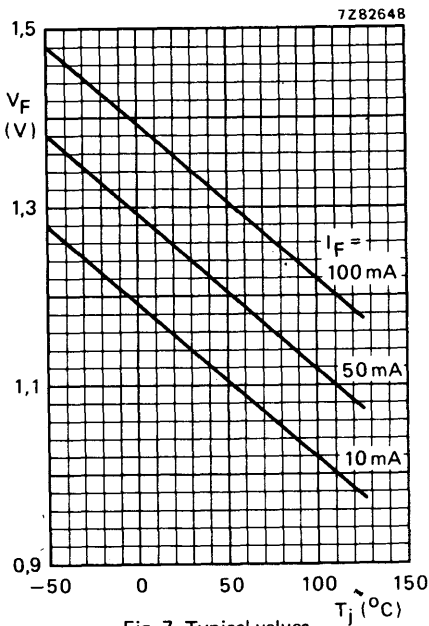

Fig. 7 Typical values.

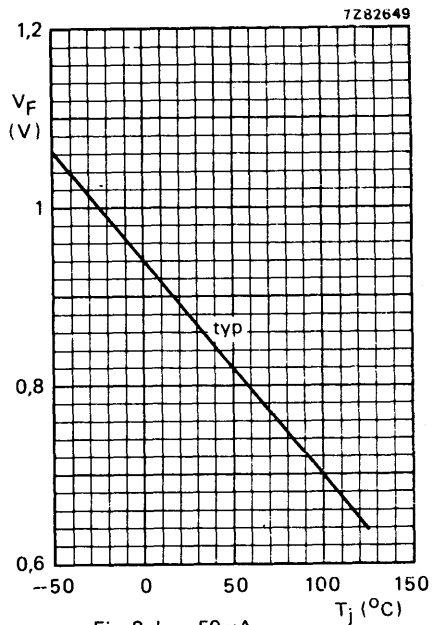

Fig. 8  $I_F = 50 \mu A$ .



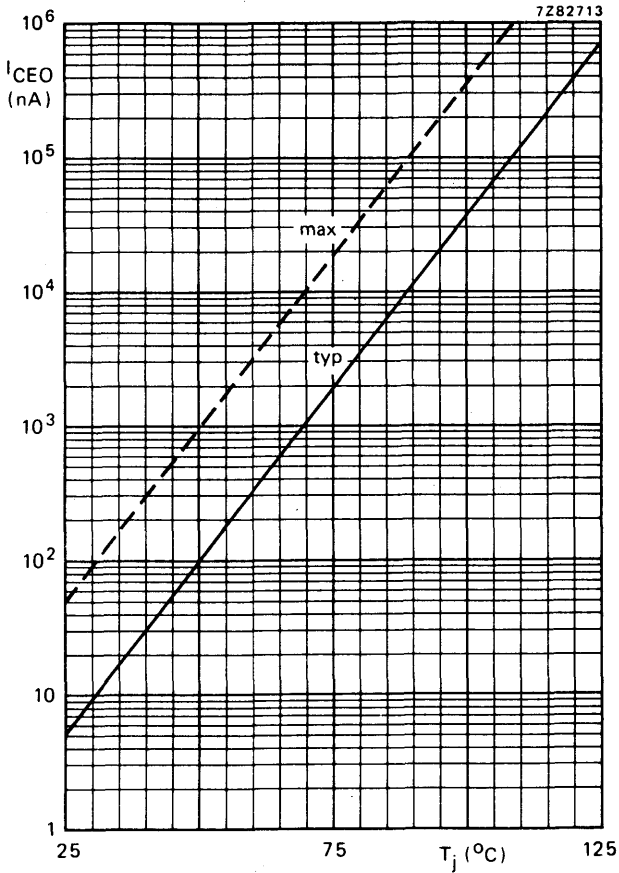

Fig. 9  $I_F = 0; V_{CE} = 10 V.$





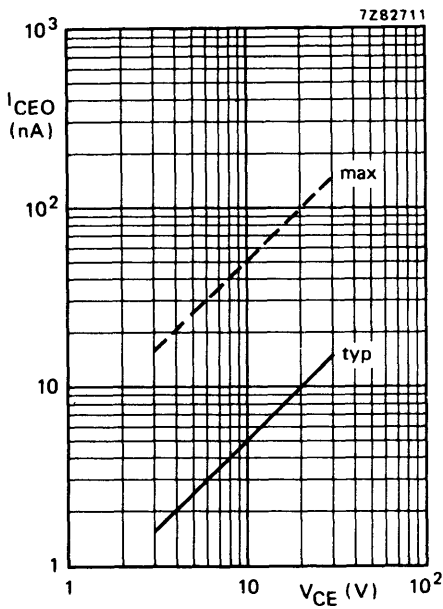

Fig. 10  $I_F = 0$ ;  $T_j = 25^\circ\text{C}$ .

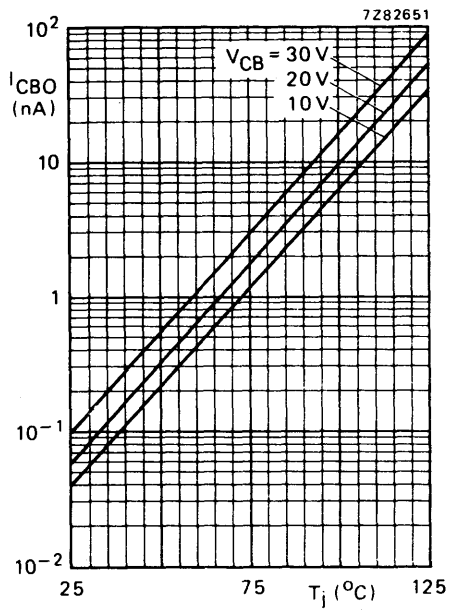

Fig. 11 Typical values.

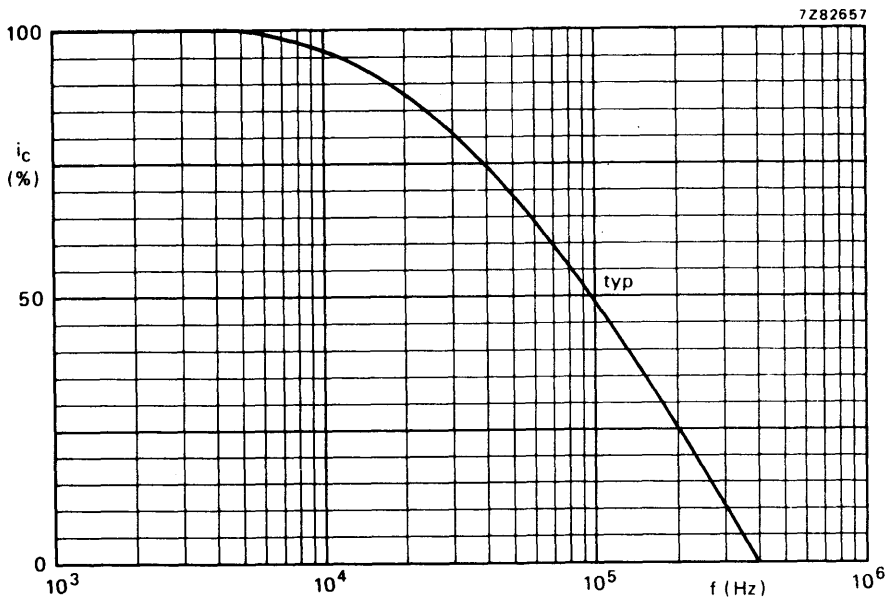

Fig. 12  $I_B = 0$ ;  $I_C = 2\text{ mA}$ ;  $V_{CC} = 5\text{ V}$ ;  $R_L = 1\text{ k}\Omega$ ;  $T_{amb} = 25^\circ\text{C}$ .



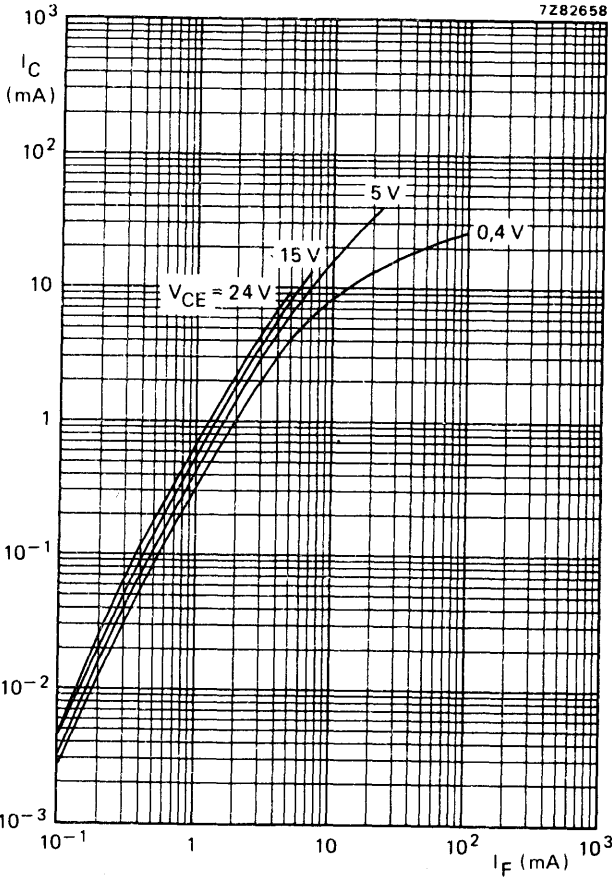

Fig. 13  $T_{amb} = 25$  °C, typical values.



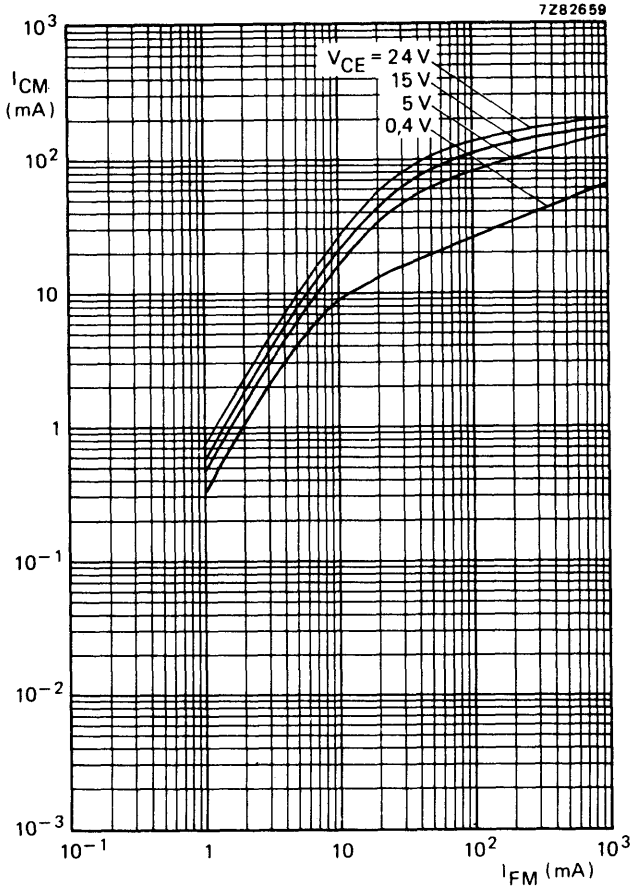

Fig. 14  $T_{amb} = 25^{\circ}C$ ;  $t_p = 10 \mu s$ ;  $T = 1 ms$ ; typical values.



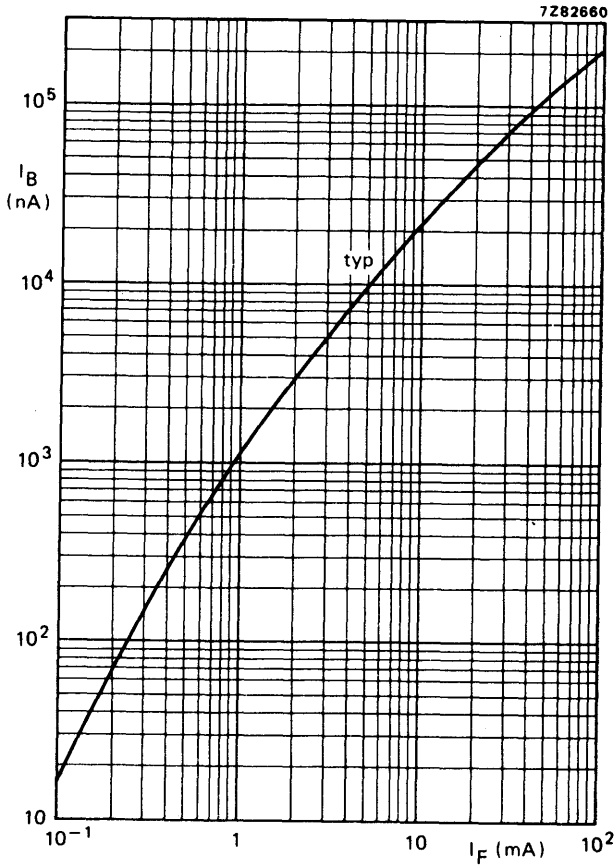

Fig. 15  $V_{CB} = 5$  V;  $T_{amb} = 25$  °C.



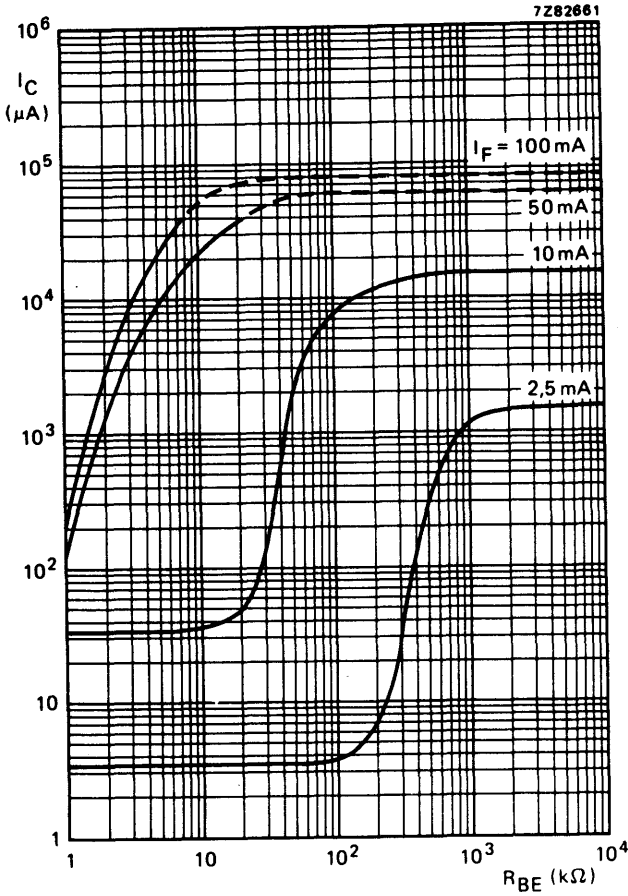

Fig. 16  $I_B = 0$ ;  $V_{CE} = 5 \text{ V}$ ;  $T_{amb} = 25 \text{ }^\circ\text{C}$ ; typical values.



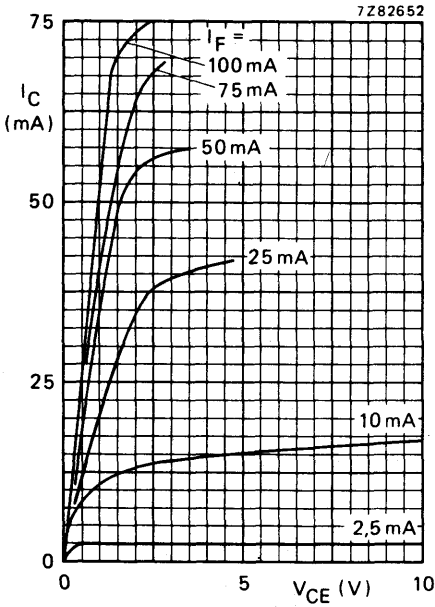

Fig. 17  $T_{amb} = 25^{\circ}C$ ; typical values.

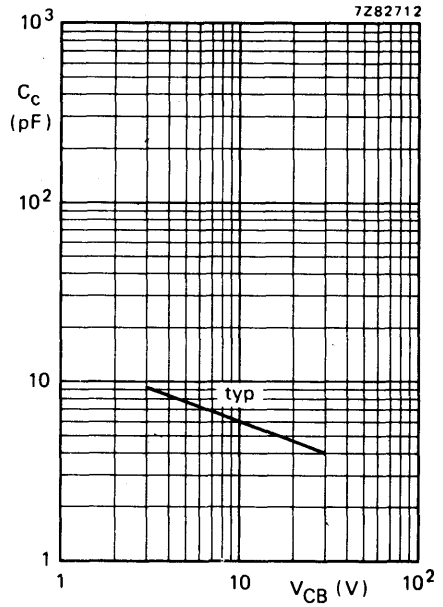

Fig. 18  $f = 1 \text{ MHz}$ ;  $T_{amb} = 25^{\circ}C$ .

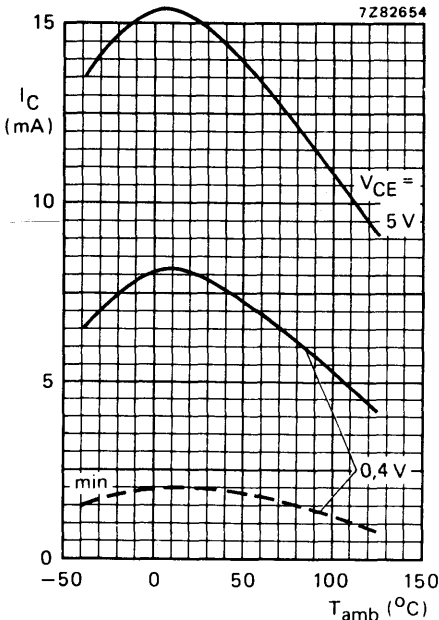

Fig. 19  $I_B = 0$ ;  $I_F = 10 \text{ mA}$ ; — typ. values.

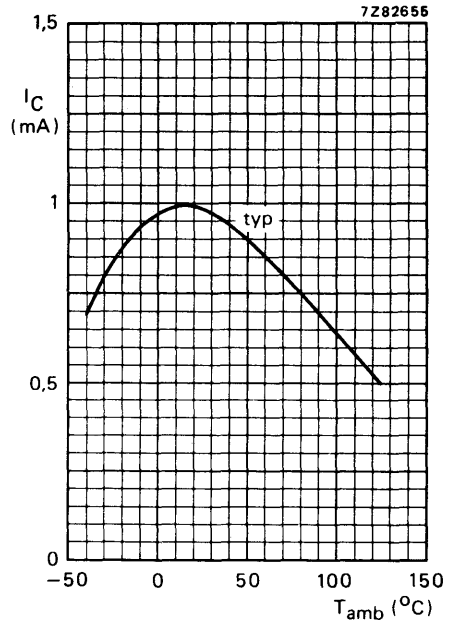

Fig. 20  $I_F = 2 \text{ mA}$ ;  $V_{CE} = 0,4 \text{ V}$ .



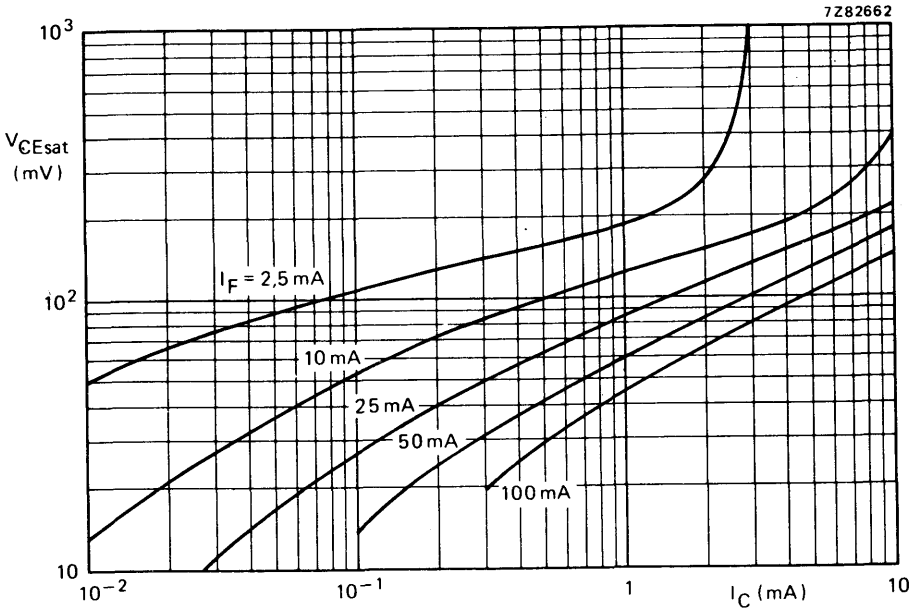

Fig. 21  $I_B = 0$ ;  $T_{amb} = 25^\circ C$ ; typical values.

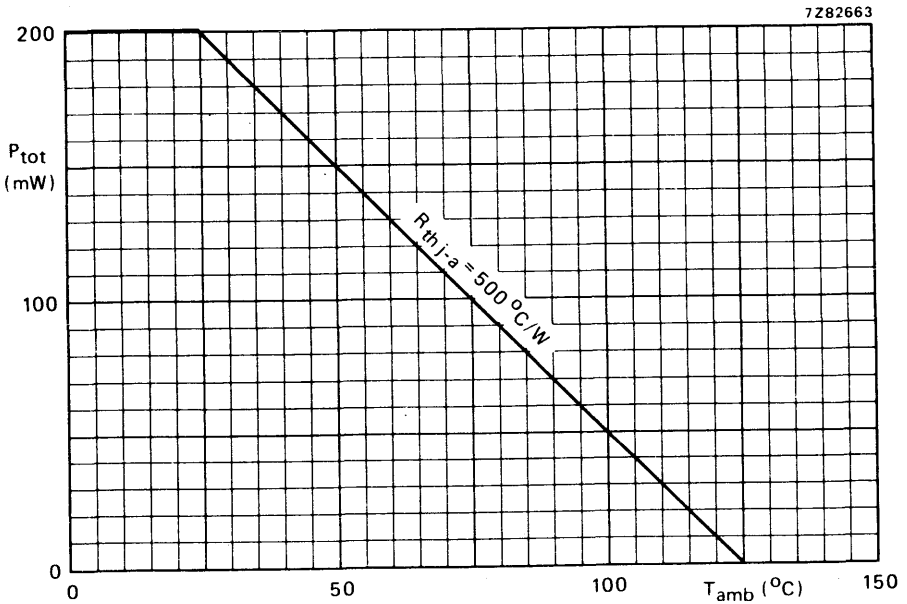

Fig. 22 Max. permissible power dissipation for total device versus ambient temperature.



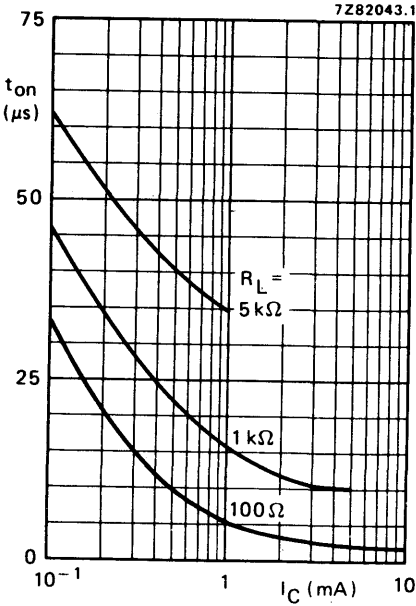

Fig. 23  $I_B = 0$ ;  $V_{CC} = 5\text{ V}$ ;  $T_{amb} = 25\text{ }^\circ\text{C}$ ; typical values. (See also Fig. 25.)

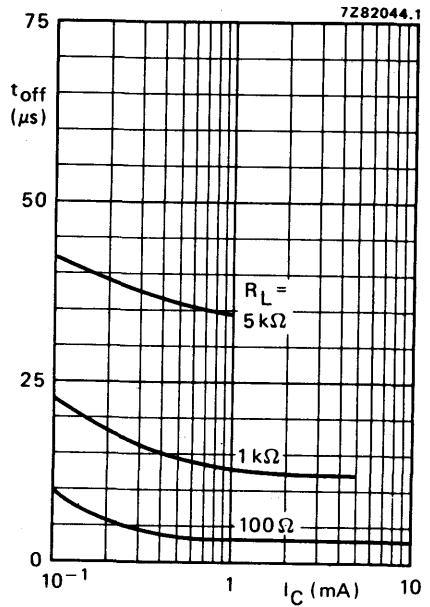

Fig. 24  $I_B = 0$ ;  $V_{CC} = 5\text{ V}$ ;  $T_{amb} = 25\text{ }^\circ\text{C}$ ; typical values. (See also Fig. 25.)

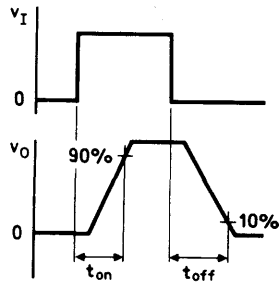
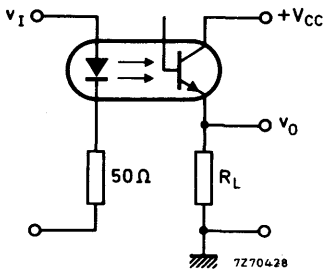

Fig. 25 Switching circuit and waveforms.





## PHOTOCOUPLER

Optically coupled isolator consisting of an infrared emitting GaAs diode and a silicon n-p-n photo-transistor with accessible base. Hermetically encapsulated in a metal envelope. The CNY50 is intended for professional applications.

## QUICK REFERENCE DATA

## Diode

Continuous reverse voltage	$V_R$	max.	3 V
Forward current	$I_F$	max.	100 mA
d.c.	$I_{FM}$	max.	3000 mA
(peak value); $t_p = 300 \mu s$ ; $\delta = 0,02$	$P_{tot}$	max.	150 mW
Total power dissipation up to $T_{amb} = 75^\circ C$			

## Transistor

Collector-emitter voltage (open base)	$V_{CEO}$	max.	35 V
Total power dissipation up to $T_{amb} = 75^\circ C$	$P_{tot}$	max.	150 mW

## Photocoupler

Output/input d.c. current transfer ratio				
$I_F = 10 \text{ mA}$ ; $V_{CE} = 0,4 \text{ V}$ ; ( $I_B = 0$ )	CNY50-1	$I_C/I_F$	>	0,25
	CNY50-2	$I_C/I_F$	>	0,40
Collector cut-off current (dark)				
$V_{CC} = 15 \text{ V}$ ; working voltage (d.c.) = 1 kV				
diode: $I_F = 0$ (see also Fig. 2)		$I_{CEW}$	<	200 nA
Isolation voltage(d.c.)		$V_{IO}$	max.	1 kV

This data must be read in conjunction with GENERAL SAFETY RECOMMENDATIONS – OPTOELECTRONIC DEVICES

## PRODUCT SAFETY

Modern high technology materials have been used in the manufacture of this device to ensure high performance. Some of these materials are toxic in certain circumstances. Mechanical or electrical damage is unlikely to give rise to any hazard, but toxic vapours may be generated if the device is heated to destruction. Disposal of large quantities should therefore be carried out in accordance with the Deposit of Poisonous Waste Act 1972 and the Control of Pollution Act 1974, or with the latest legislation.



**MECHANICAL DATA**

Fig. 1 SOT-104B.

Dimensions in mm

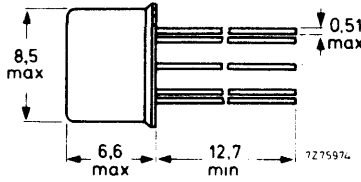
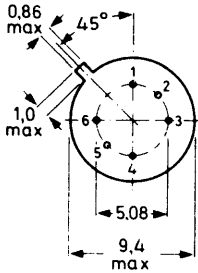

**Pinning**

- 1 emitter
- 2 base
- 3 collector
- 4 anode
- 5 internal connection
- 6 cathode

Maximum lead diameter guaranteed only for 12,7 mm.

**RATINGS**

Limiting values in accordance with the Absolute Maximum System (IEC 134)

**Diode**

Continuous reverse voltage	$V_R$	max.	3 V
Forward current	$I_F$	max.	100 mA
d.c.	$I_{FM}$	max.	3000 mA
(peak value); $t_p = 300 \mu s$ ; $\delta = 0,02$	$P_{tot}$	max.	150 mW
Total power dissipation up to $T_{amb} = 75 \text{ }^\circ\text{C}$ (see Fig. 2)	$T_j$	max.	125 $^\circ\text{C}$
Operating junction temperature			

**Transistor**

Collector-base voltage (open emitter)	$V_{CBO}$	max.	70 V
Collector-emitter voltage (open base)	$V_{CEO}$	max.	35 V
Emitter-collector voltage (open base)	$V_{ECO}$	max.	7 V
Collector current (d.c.)	$I_C$	max.	100 mA
Total power dissipation up to $T_{amb} = 75 \text{ }^\circ\text{C}$	$P_{tot}$	max.	150 mW
Operating junction temperature	$T_j$	max.	125 $^\circ\text{C}$

**Photocoupler**

Total power dissipation up to $T_{amb} = 75 \text{ }^\circ\text{C}$	$P_{tot}$	max.	300 mW
Storage temperature	$T_{stg}$		-65 to +150 $^\circ\text{C}$
Operating ambient temperature	$T_{amb}$		-40 to +85 $^\circ\text{C}$

**THERMAL RESISTANCE**

From junction to ambient in free air			
diode	$R_{th j-a}$	=	330 $^\circ\text{C/W}$
transistor	$R_{th j-a}$	=	330 $^\circ\text{C/W}$



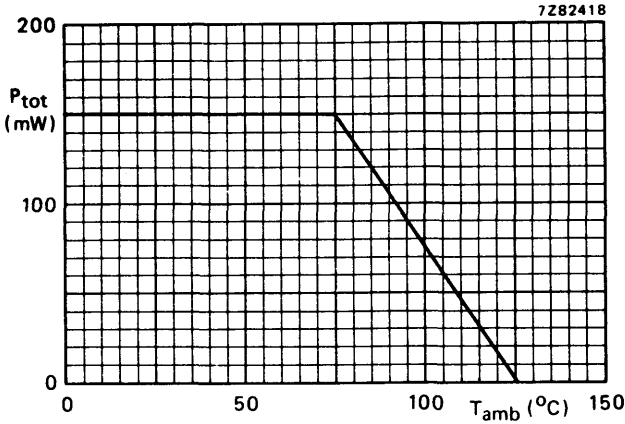

Fig. 2 Power/temperature derating curve for diode and transistor.

**CHARACTERISTICS**

T<sub>j</sub> = 25 °C unless otherwise specified

**Diode**

Forward voltage

I<sub>F</sub> = 2 mA; T<sub>amb</sub> = 0 °C to 70 °C

V<sub>F</sub> < 1,2 V

I<sub>F</sub> = 10 mA

V<sub>F</sub> typ. 1,15 V  
< 1,50 V

Reverse current

V<sub>R</sub> = 3 V

I<sub>R</sub> typ. .1 μA  
< 100 μA

Diode capacitance

V<sub>R</sub> = 0; f = 1 MHz

C<sub>d</sub> typ. 75 pF

**Transistor** (diode: I<sub>F</sub> = 0)

Collector-base breakdown voltage

open emitter; I<sub>C</sub> = 0,1 mA

V<sub>(BR)CBO</sub> > 70 V

Collector-emitter breakdown voltage

open base; I<sub>C</sub> = 1 mA

V<sub>(BR)CEO</sub> > 35 V

Emitter-collector breakdown voltage

open base; I<sub>E</sub> = 0,1 mA

V<sub>(BR)ECO</sub> > 7 V

Collector cut-off current (dark)

I<sub>E</sub> = 0; V<sub>CB</sub> = 10 V

I<sub>CBO</sub> < 20 nA

I<sub>B</sub> = 0; V<sub>CE</sub> = 20 V

I<sub>CEO</sub> typ. 5 nA  
< 100 nA

I<sub>B</sub> = 0; V<sub>CE</sub> = 20 V; T<sub>amb</sub> = 70 °C

I<sub>CEO</sub> < 10 μA

D.C. current gain

I<sub>C</sub> = 10 mA; V<sub>CE</sub> = 5 V

h<sub>FE</sub> typ. 600



**Photocoupler ( $I_B = 0$ )\***

Collector cut-off current (light)

$V_F = 0,8 \text{ V}$ ;  $V_{CE} = 15 \text{ V}$ ;  $T_{amb} = 0 \text{ }^\circ\text{C}$  to  $70 \text{ }^\circ\text{C}$

$I_F = 2 \text{ mA}$ ;  $V_{CE} = 0,4 \text{ V}$ ;  $T_{amb} = 0 \text{ }^\circ\text{C}$  to  $70 \text{ }^\circ\text{C}$

Output/input d.c. current transfer ratio

$I_F = 10 \text{ mA}$ ;  $V_{CE} = 0,4 \text{ V}$

CNY50-1	$I_C$	<	15 $\mu\text{A}$
CNY50-2	$I_C$	<	150 $\mu\text{A}$
CNY50-1	$I_C/I_F$	typ.	0,4
			0,25 to 1,0
CNY50-2	$I_C/I_F$	typ.	0,8
			0,40 to 1,6

Collector cut-off current (dark) see Fig. 3

$V_{CC} = 15 \text{ V}$ ; working voltage (d.c.) =  $1 \text{ kV}$

$T_j = 25 \text{ }^\circ\text{C}$

$T_j = 70 \text{ }^\circ\text{C}$

$I_{CEW}$	<	200 nA
$I_{CEW}$	<	100 $\mu\text{A}$

\* Where the phototransistor receives light from the diode the O (for open base) has been omitted from the symbols.

Isolation voltage, d.c. value  
measured between shorted input leads  
and shorted output leads

$V_{IO}$	max.	1 kV
----------	------	------

Capacitance between input and output

$I_F = 0$ ;  $V = 0$ ;  $f = 1 \text{ MHz}$

$C_{io}$	typ.	1 pF
----------	------	------

Insulation resistance between input and output

$\pm V_{IO} = 500 \text{ V}$

$r_{IO}$	>	100 $\text{G}\Omega$
	typ.	1000 $\text{G}\Omega$

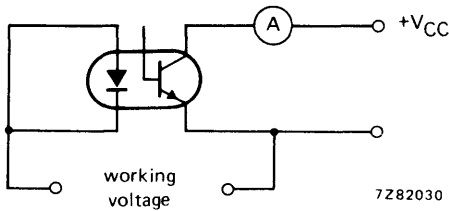

Fig. 3.



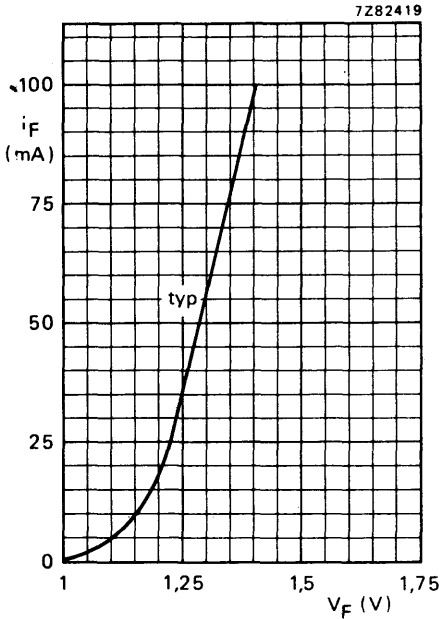

Fig. 4  $T_{amb} = 25^\circ C$ .

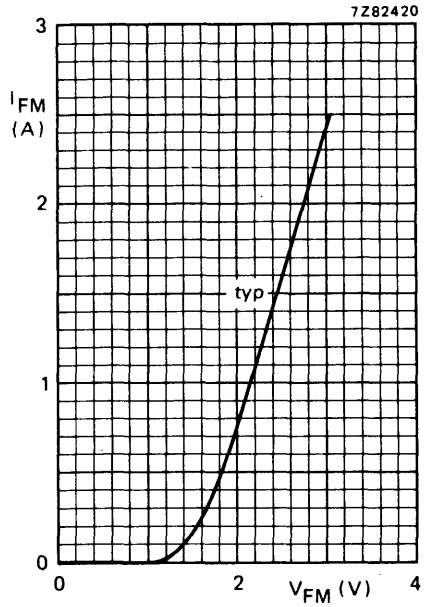

Fig. 5  $T_{amb} = 25^\circ C$ ;  $t_p = 10 \mu s$ ;  $\delta = 0,01$ .

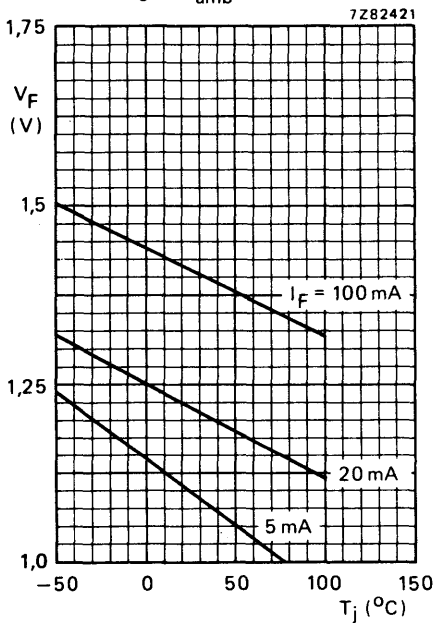

Fig. 6 Typical values.

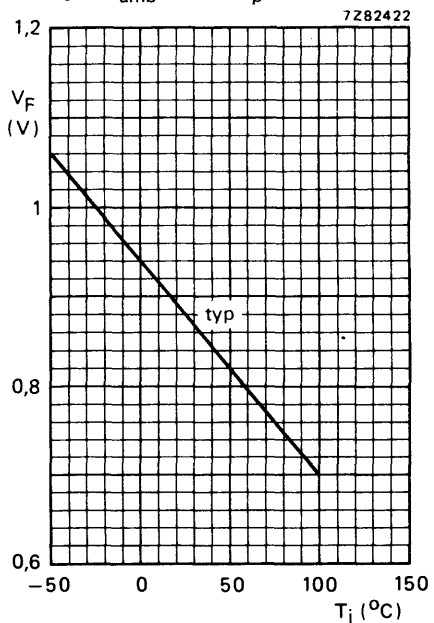

Fig. 7  $I_F = 50 \mu A$ .



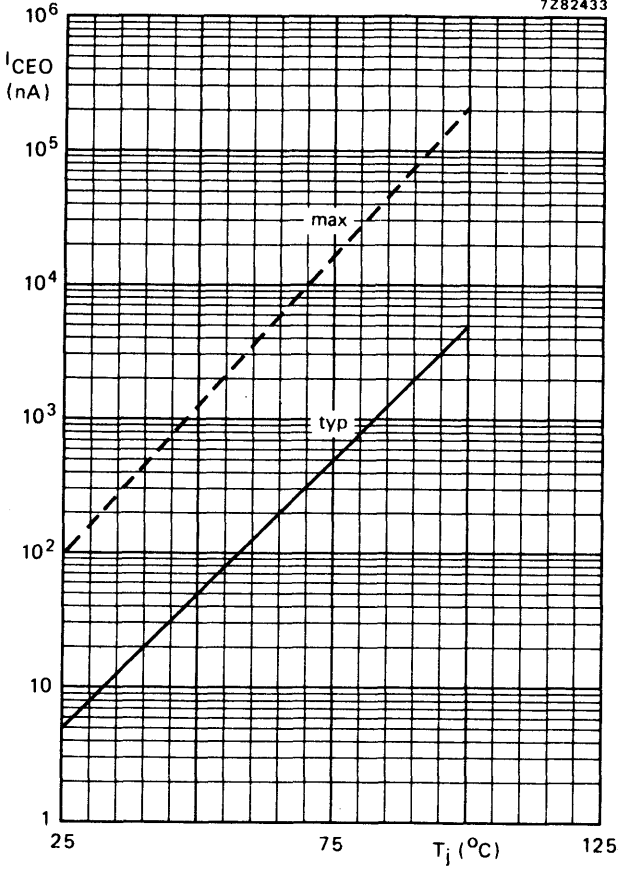

Fig. 8  $I_F = 0$ ;  $V_{CE} = 20$  V.



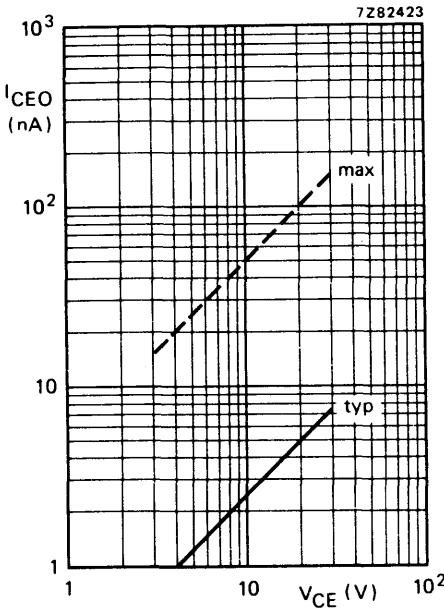

Fig. 9  $I_F = 0$ ;  $T_j = 25^\circ\text{C}$ .

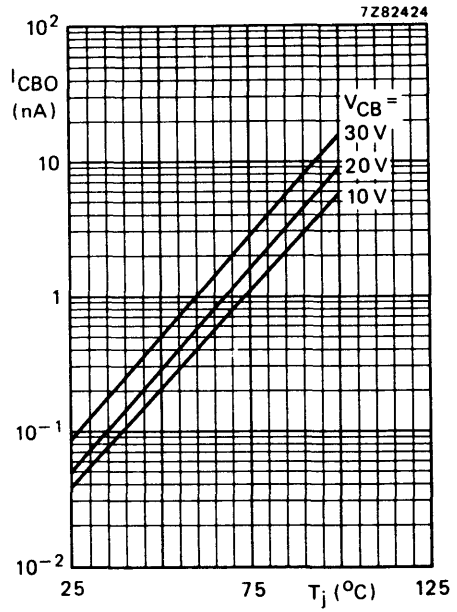

Fig. 10  $I_F = 0$ ; typical values.

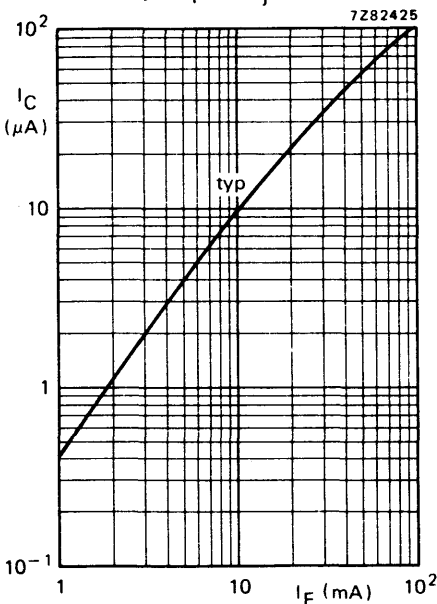

Fig. 11  $I_E = 0$ ;  $V_{CB} = 5\text{ V}$ ;  $T_{amb} = 25^\circ\text{C}$ .

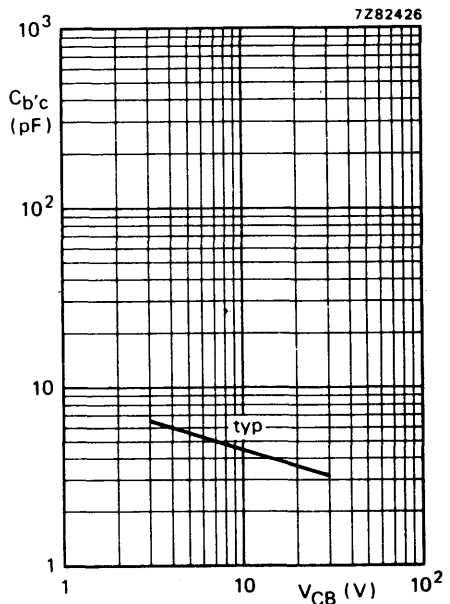

Fig. 12  $f = 1\text{ MHz}$ ;  $T_{amb} = 25^\circ\text{C}$ .



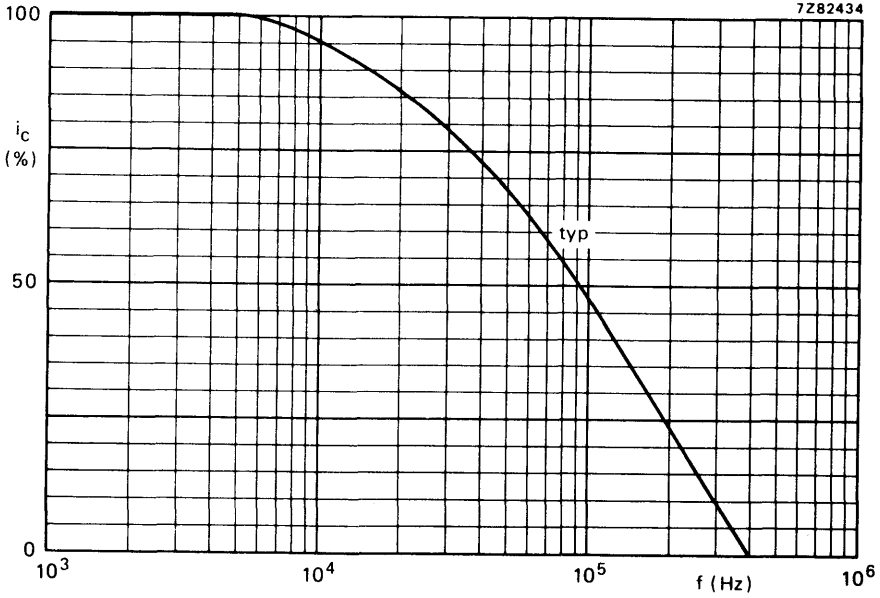

Fig. 13  $I_B = 0$ ;  $I_C = 2$  mA;  $V_{CC} = 5$  V;  $R_L = 1$  k $\Omega$ ;  $T_{amb} = 25$  °C.

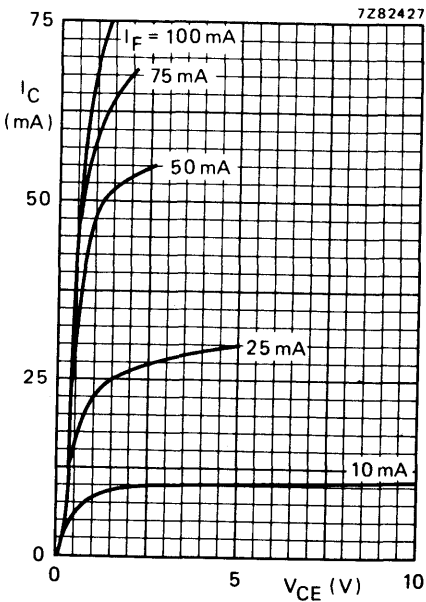

Fig. 14  $T_{amb} = 25$  °C; typical values.

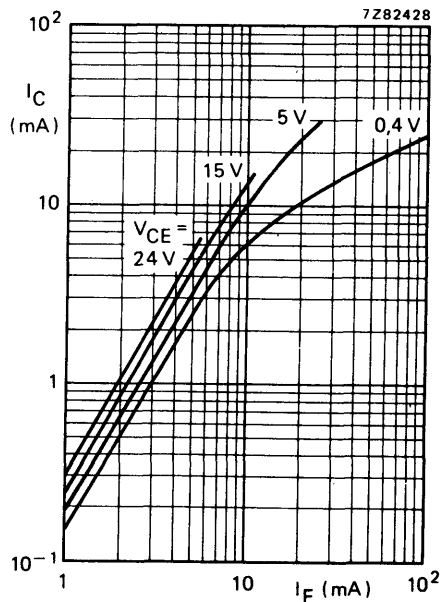

Fig. 15  $T_{amb} = 25$  °C; typical values.





7Z82435

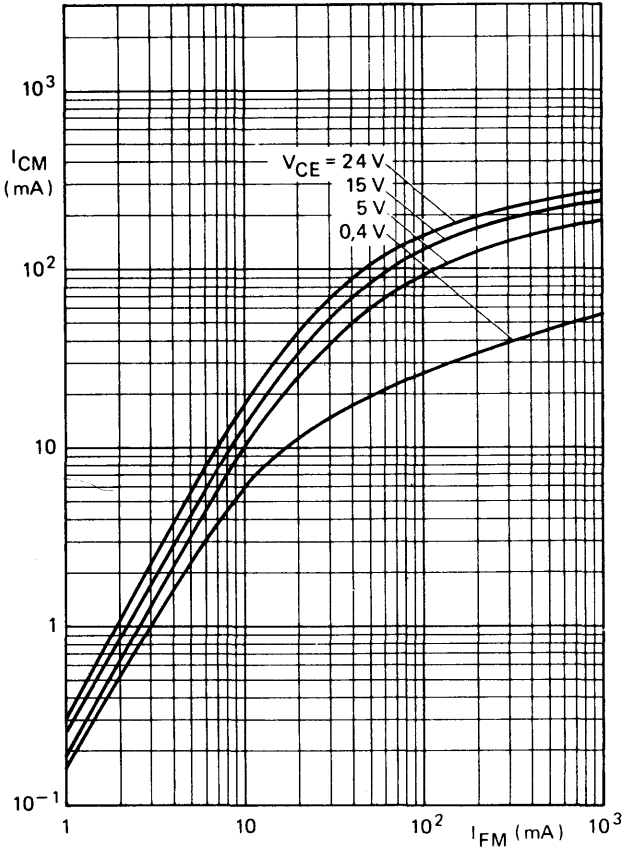

Fig. 16  $T_{amb} = 25^{\circ}C$ ;  $t_p = 10 \mu s$ ;  $\delta = 0,01$ ; typical values.



7282436

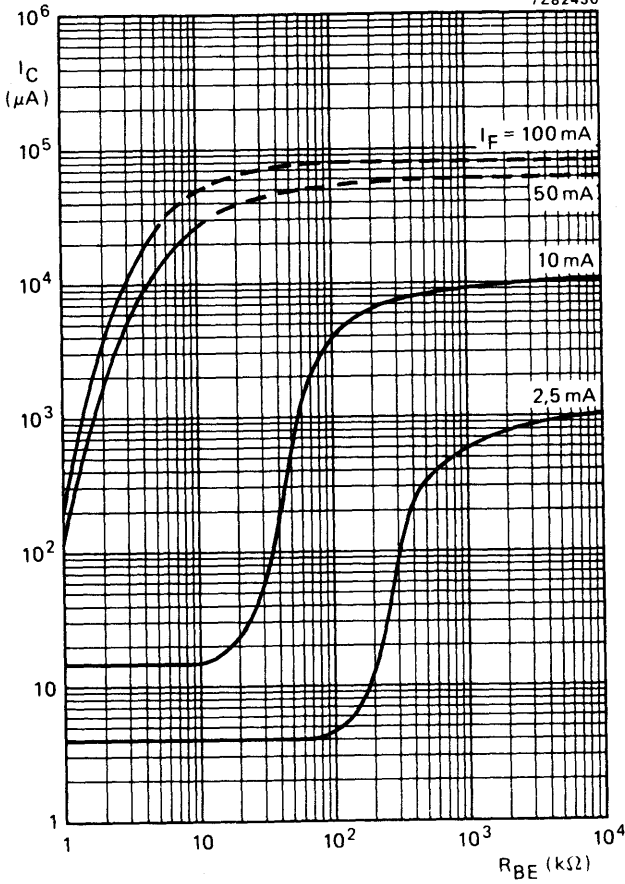

Fig. 17  $I_B = 0$ ;  $V_{CE} = 5 \text{ V}$ ;  $T_{amb} = 25 \text{ }^\circ\text{C}$ ; typical values.



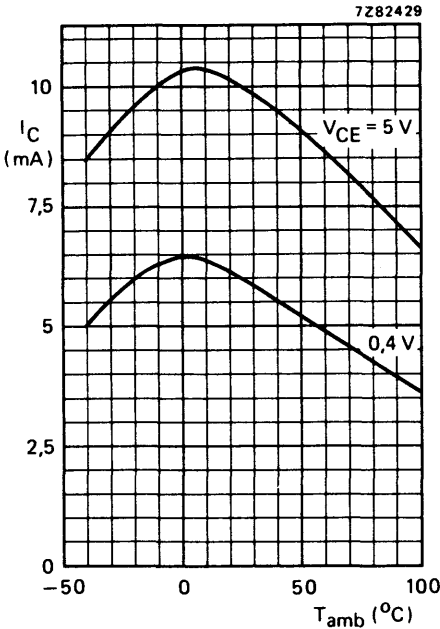

Fig. 18  $I_B = 0$ ;  $I_F = 10$  mA; typical values.

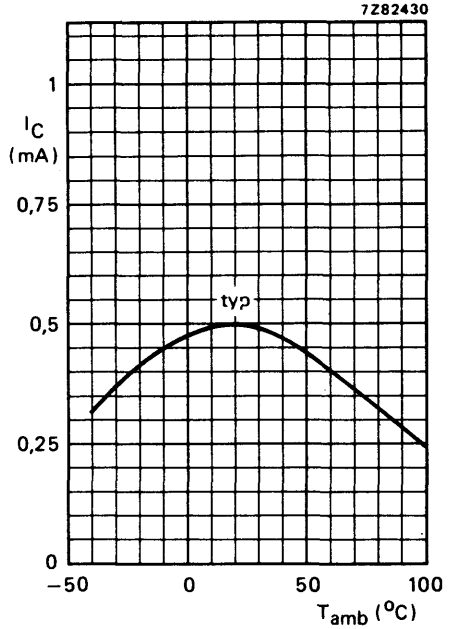

Fig. 19  $I_B = 0$ ;  $I_F = 2$  mA;  $V_{CE} = 0,4$  V.

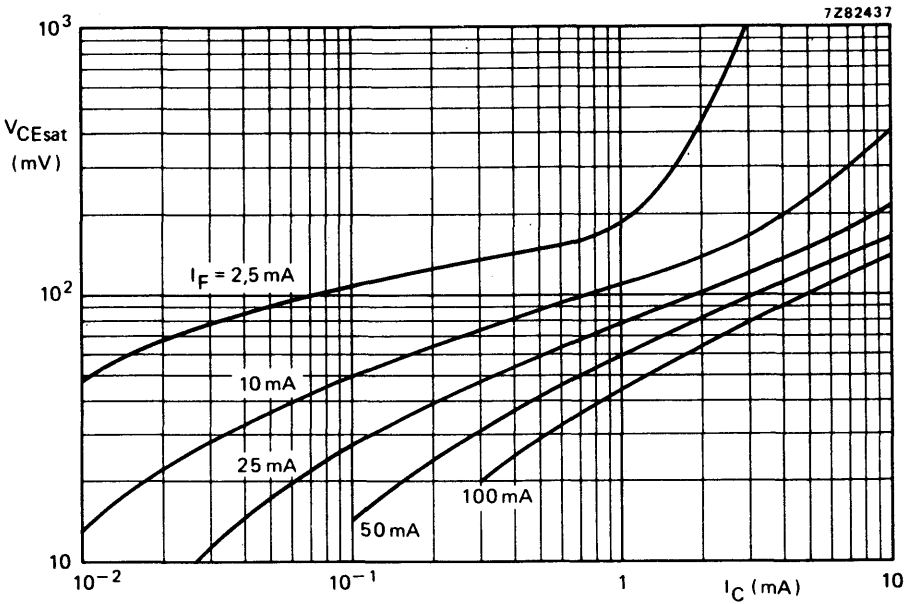

Fig. 20  $I_B = 0$ ;  $T_{amb} = 25$  °C; typical values.



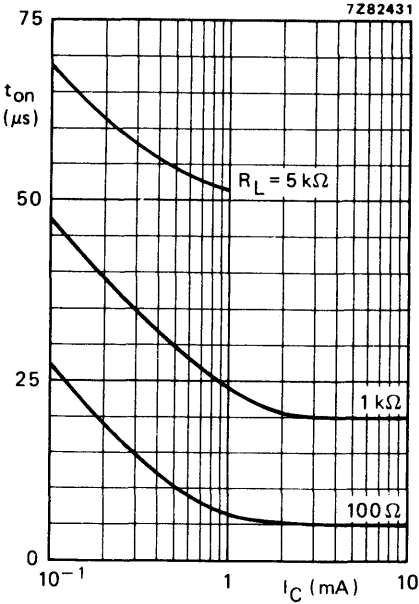

Fig. 21  $I_B = 0$ ;  $V_{CC} = 5 V$ ;  $T_{amb} = 25 ^\circ C$ ; typical values. (See Fig. 23).

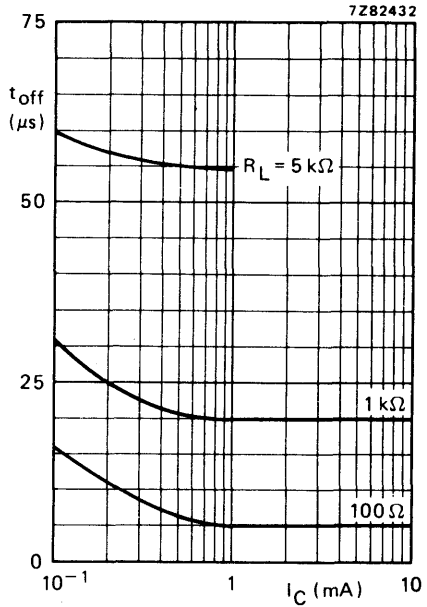
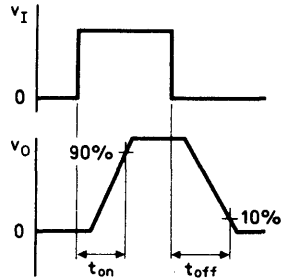
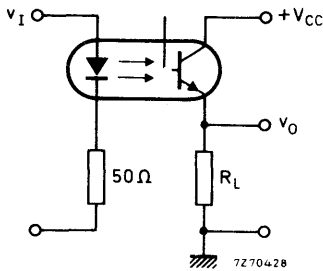

Fig. 22  $I_B = 0$ ;  $V_{CC} = 5 V$ ;  $T_{amb} = 25 ^\circ C$ ; typical values. (See Fig. 23).



7267238.1

Fig. 23 Switching circuit and waveforms.



## PHOTOCOUPLERS

Optically coupled isolators consisting of an infrared emitting GaAs diode and a silicon n-p-n photo-transistor without accessible base. Plastic envelopes. Suitable for TTL integrated circuits.

Features of these products:

- high output/input d.c. current transfer ratio;
- low saturation voltage;
- a high isolation voltage  
**CNY62** 3,75 kV (r.m.s.) and 5,3 kV (d.c.);  
**CNY63** 3 kV (r.m.s.) and 4,3 kV (d.c.);
- working voltage 1,5 kV.

### QUICK REFERENCE DATA

Diode		CNY62	CNY63
Continuous reverse voltage	$V_R$	max. 3	3 V
Forward current			
d.c.	$I_F$	max. 100	100 mA
(peak value); $t_p = 10 \mu s$ ; $\delta = 0,1$	$I_{FM}$	max. 1000	1000 mA
Total power dissipation up to $T_{amb} = 25 \text{ }^\circ\text{C}$	$P_{tot}$	max. 150	150 mW
<b>Transistor</b>			
Collector-emitter voltage (open base)	$V_{CEO}$	max. 50	30 V
Total power dissipation up to $T_{amb} = 25 \text{ }^\circ\text{C}$	$P_{tot}$	max. 200	200 mW
<b>Photocoupler</b>			
Output/input d.c. current transfer ratio			
$I_F = 10 \text{ mA}$ ; $V_{CE} = 0,4 \text{ V}$ ; ( $I_B = 0$ )	$I_C/I_F$	> 0,25	0,50
Collector cut-off current (dark)			
$V_{CC} = 10 \text{ V}$ ; working voltage (d.c.) = 1,5 kV			
diode: $I_F = 0$ (see also Fig. 2)	$I_{CEW}$	< 200	200 nA
Isolation voltage (d.c.)			
$t = 1 \text{ min}$	$V_{IO}$	max. 5,3	4,3 kV

This data must be read in conjunction with GENERAL SAFETY RECOMMENDATIONS – OPTOELECTRONIC DEVICES

### PRODUCT SAFETY

Modern high technology materials have been used in the manufacture of this device to ensure high performance. Some of these materials are toxic in certain circumstances. Mechanical or electrical damage is unlikely to give rise to any hazard, but toxic vapours may be generated if the device is heated to destruction. Disposal of large quantities should therefore be carried out in accordance with the Deposit of Poisonous Waste Act 1972 and the Control of Pollution Act 1974, or with the latest legislation.



MECHANICAL DATA

Dimensions in mm

Fig. 1 SOT-91B.

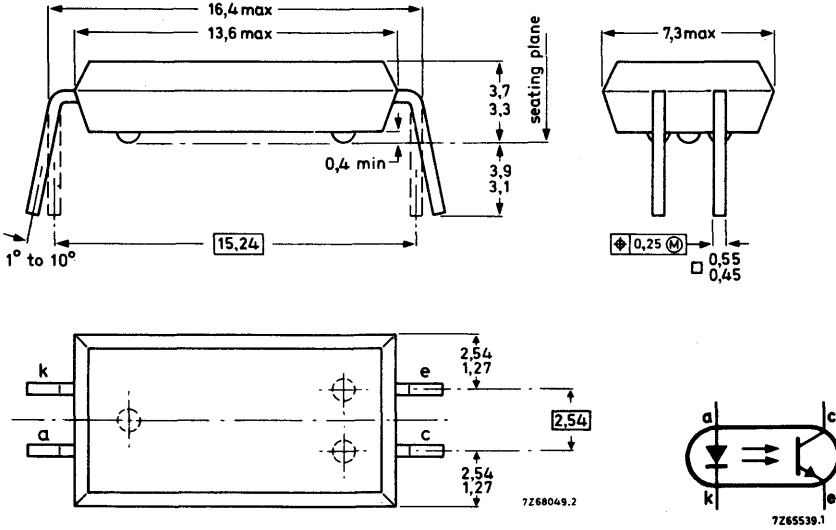

- $\oplus$  Positional accuracy.
- $\textcircled{M}$  Maximum material condition.

RATINGS

Limiting values in accordance with the Absolute Maximum System (IEC 134)

Diode

Continuous reverse voltage	$V_R$	max.	3 V
Forward current			
d.c.	$I_F$	max.	100 mA
(peak value); $t_p = 10 \mu s$ ; $\delta = 0,1$	$I_{FM}$	max.	1000 mA
Total power dissipation up to $T_{amb} = 25 \text{ }^\circ\text{C}$	$P_{tot}$	max.	150 mW
Operating junction temperature	$T_j$	max.	125 $^\circ\text{C}$

Transistor

Collector-emitter voltage (open base)	CNY62	$V_{CE0}$	max.	50 V
	CNY63	$V_{CE0}$	max.	30 V
Emitter-collector voltage (open base)		$V_{ECO}$	max.	7 V
Collector current (d.c.)		$I_C$	max.	100 mA



Total power dissipation up to  $T_{amb} = 25\text{ }^{\circ}\text{C}$  $P_{tot}$  max. 200 mW

Operating junction temperature

 $T_j$  max. 125  $^{\circ}\text{C}$ **Photocoupler**

Storage temperature

 $T_{stg}$  -55 to +150  $^{\circ}\text{C}$ 

Lead soldering temperature

up to the seating plane;  $t_{sld} < 10\text{ s}$  $T_{sld}$  max. 260  $^{\circ}\text{C}$ **THERMAL RESISTANCE**From junction to ambient in free air  
diode $R_{th\ j-a} = 0,65\text{ }^{\circ}\text{C/mW}$ 

transistor

 $R_{th\ j-a} = 0,5\text{ }^{\circ}\text{C/mW}$ From junction to ambient, device  
mounted on a printed-circuit board

diode

 $R_{th\ j-a} = 0,6\text{ }^{\circ}\text{C/mW}$ 

transistor

 $R_{th\ j-a} = 0,4\text{ }^{\circ}\text{C/mW}$ **CHARACTERISTICS** $T_j = 25\text{ }^{\circ}\text{C}$  unless otherwise specified**Diode**

Forward voltage

 $I_F = 10\text{ mA}$  $V_F$  typ. 1,2 V  
< 1,5 V

Reverse current

 $V_R = 3\text{ V}$  $I_R$  < 10  $\mu\text{A}$ **Transistor** (diode:  $I_F = 0$ )

Collector cut-off current (dark)

 $V_{CE} = 10\text{ V}$  $I_{CEO}$  typ. 5 nA  
< 100 nA $V_{CE} = 10\text{ V}; T_{amb} = 70\text{ }^{\circ}\text{C}$  $I_{CEO}$  < 10  $\mu\text{A}$ **Photocoupler** ( $I_B = 0$ )\*

Output/input d.c. current transfer ratio

 $I_F = 10\text{ mA}; V_{CE} = 0,4\text{ V}$ **CNY62**  $I_C/I_F$  > 0,25  
typ. 0,50**CNY63**  $I_C/I_F$  > 0,5  
typ. 1,0

Collector cut-off current (dark) see Fig. 2

 $V_{CC} = 10\text{ V};$  working voltage (d.c.) = 1,5 kV $I_{CEW}$  < 200 nA $V_{CC} = 10\text{ V};$  working voltage (d.c.) = 1,5 kV;  $T_j = 70\text{ }^{\circ}\text{C}$  $I_{CEW}$  < 100  $\mu\text{A}$ 

\* Where the phototransistor receives light from the diode the O (for open base) has been omitted from the symbols.



CNY62  
CNY63

Collector-emitter saturation voltage

$I_F = 10 \text{ mA}; I_C = 2 \text{ mA}$

$I_F = 10 \text{ mA}; I_C = 4 \text{ mA}$

Isolation voltage, d.c. value\*

Capacitance between input and output

$I_F = 0; V = 0; f = 1 \text{ MHz}$

Insulation resistance between input and output

$\pm V_{IO} = 1 \text{ kV}$

Switching times (see Figs 3 and 4)

$I_{Con} = 2 \text{ mA}; V_{CC} = 5 \text{ V}; R_L = 100 \Omega$

Turn-on time

Turn-off time

$I_{Con} = 4 \text{ mA}; V_{CC} = 5 \text{ V}; R_L = 100 \Omega$

Turn-on time

Turn-off time

		CNY62	CNY63
$V_{CEsat}$	typ.	0,17	— V
	<	0,40	— V
$V_{CEsat}$	typ.	—	0,17 V
	<	—	0,40 V
$V_{IO}$	<	5,3	4,3 kV
$C_{io}$	typ.	0,6	0,6 pF
$r_{IO}$	>	$10^{10}$	$10^{10} \Omega$
	typ.	$10^{12}$	$10^{12} \Omega$
$t_{on}$	typ.	3	— $\mu s$
$t_{off}$	typ.	3	— $\mu s$
$t_{on}$	typ.	—	5 $\mu s$
$t_{off}$	typ.	—	5 $\mu s$

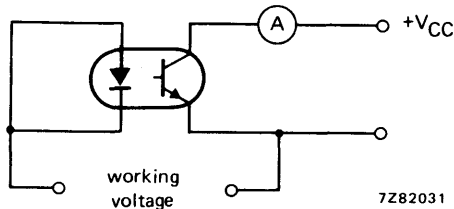

Fig. 2.

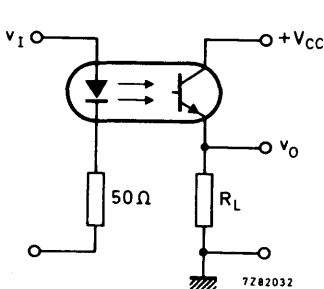

Fig. 3 Switching circuit.

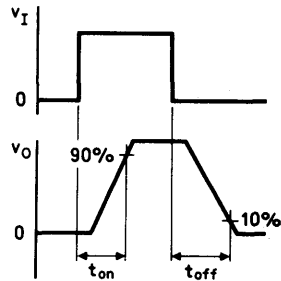

Fig. 4 Waveforms.

\* Tested with a d.c. voltage for 1 minute between shorted input leads and shorted output leads.





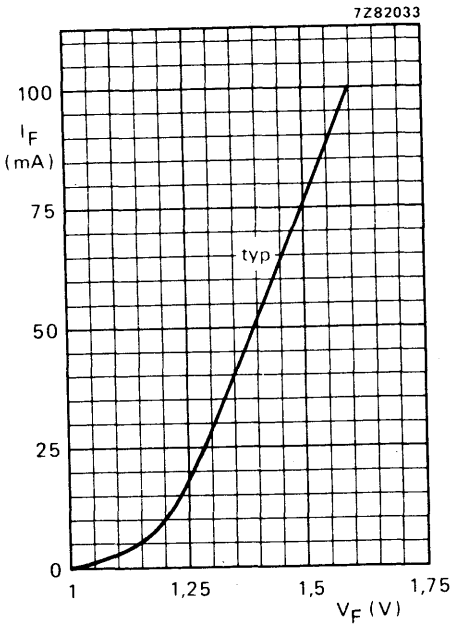

Fig. 5  $T_{amb} = 25^\circ C$ .

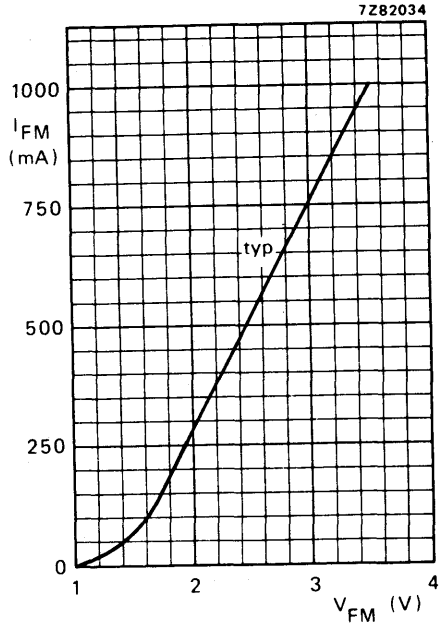

Fig. 6  $T_{amb} = 25^\circ C$ ;  $t_p = 10 \mu s$ ;  $T = 1 ms$ .

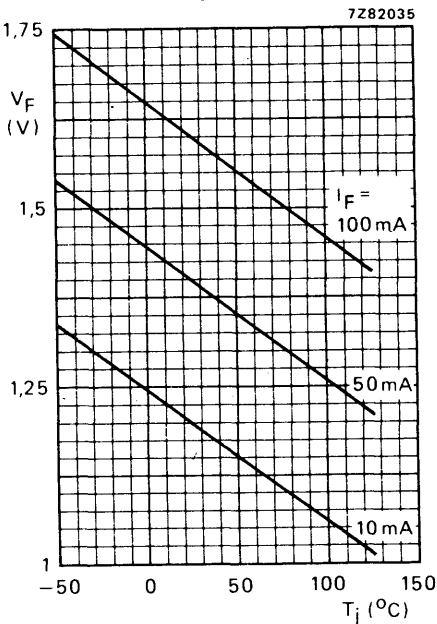

Fig. 7 Typical values.

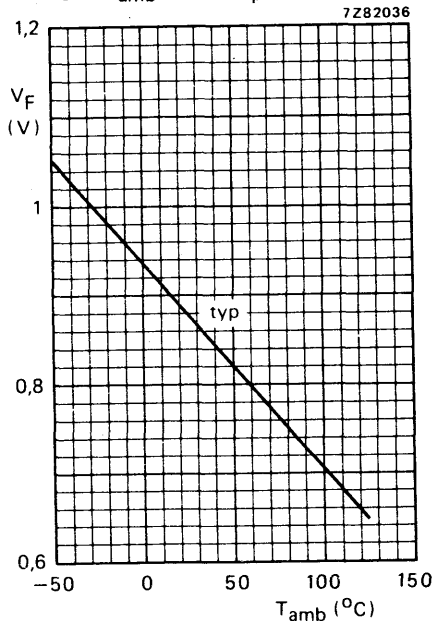

Fig. 8  $I_F = 50 \mu A$ .



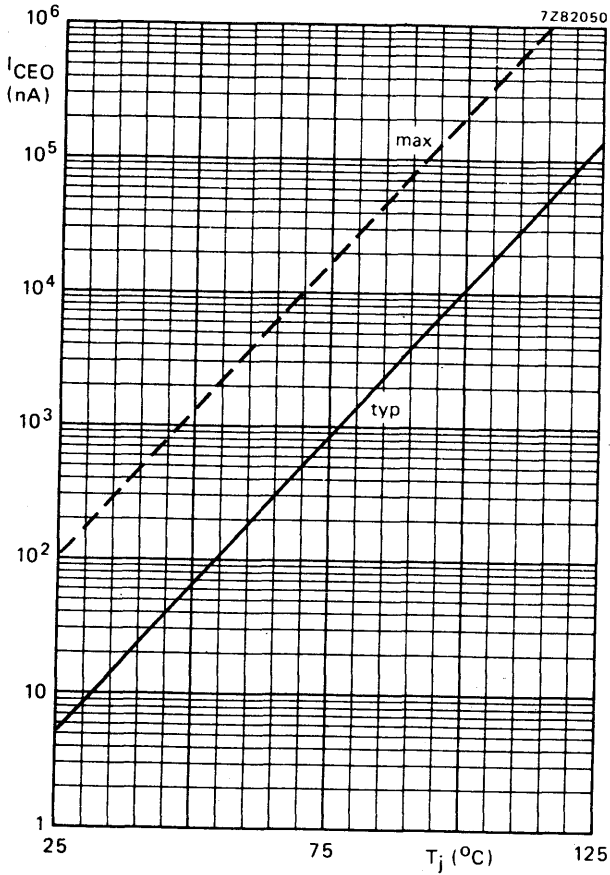

Fig. 9  $I_F = 0$ ;  $V_{CE} = 10$  V.



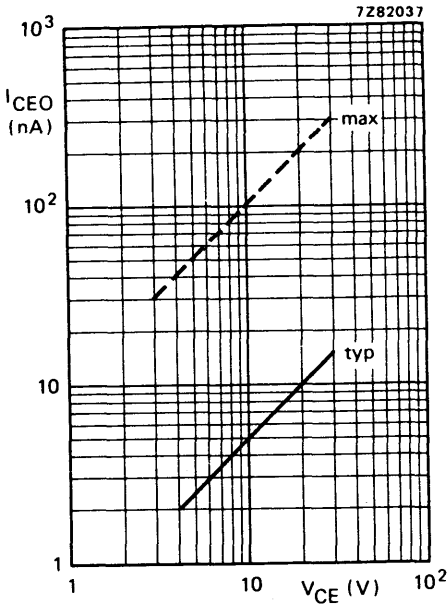

Fig. 10  $I_F = 0$ ;  $T_j = 25^\circ\text{C}$ .

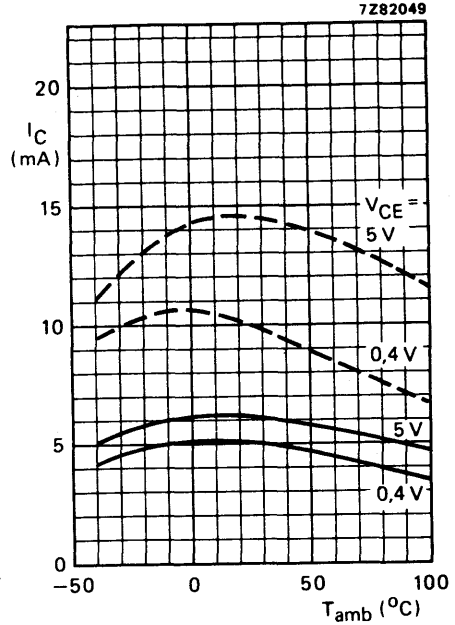

Fig. 11  $I_B = 0$ ;  $I_F = 10\text{ mA}$ ;  
— CNY62; --- CNY63; typical values.

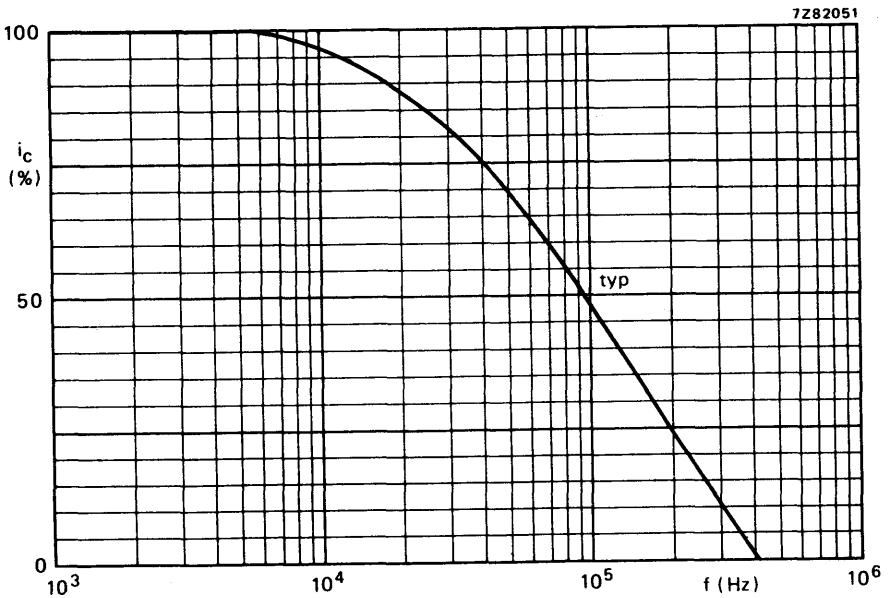

Fig. 12  $I_B = 0$ ;  $I_C = 2\text{ mA}$ ;  $V_{CC} = 5\text{ V}$ ;  $R_L = 1\text{ k}\Omega$ ;  $T_{amb} = 25^\circ\text{C}$ .



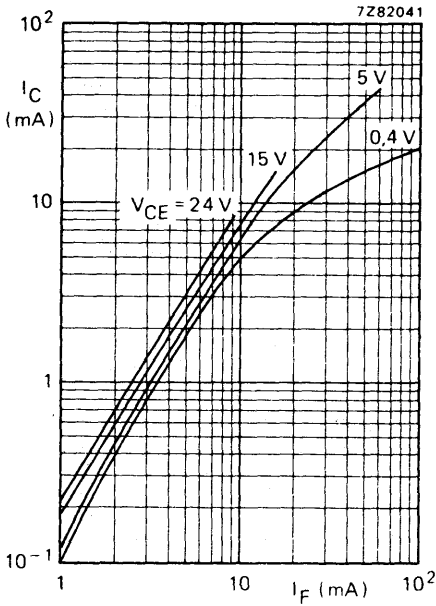

Fig. 13 CNY62;  $T_{amb} = 25$  °C; typical values.

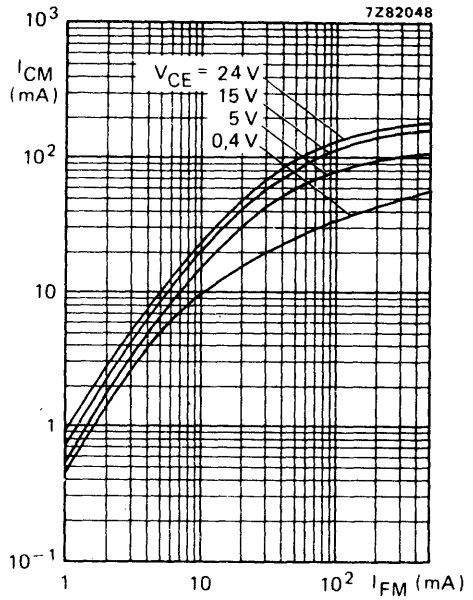

Fig. 14 CNY63;  $T_{amb} = 25$  °C;  $t_p = 10$   $\mu$ s;  $T = 1$  ms; typical values.

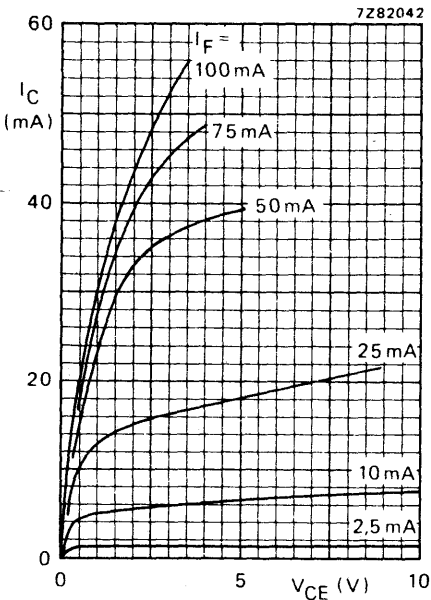

Fig. 15 CNY62;  $T_{amb} = 25$  °C; typical values.

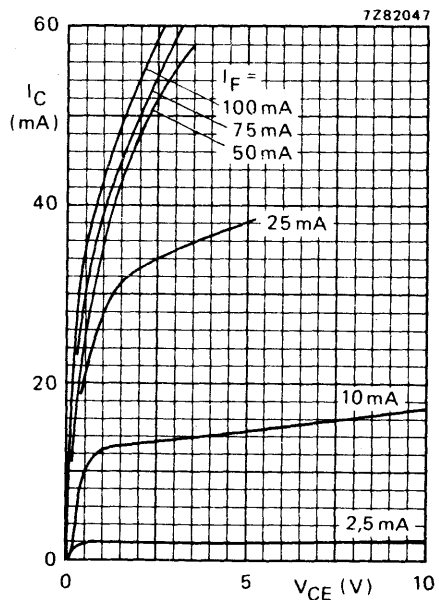

Fig. 16 CNY63;  $T_{amb} = 25$  °C; typical values.



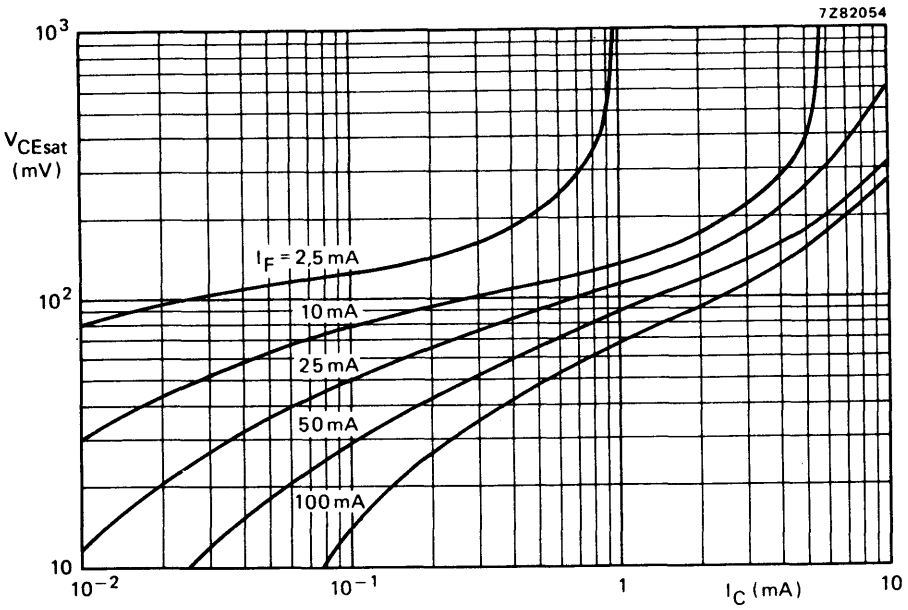

Fig. 17 CNY62;  $I_B = 0$ ;  $T_{amb} = 25^\circ C$ ; typical values.

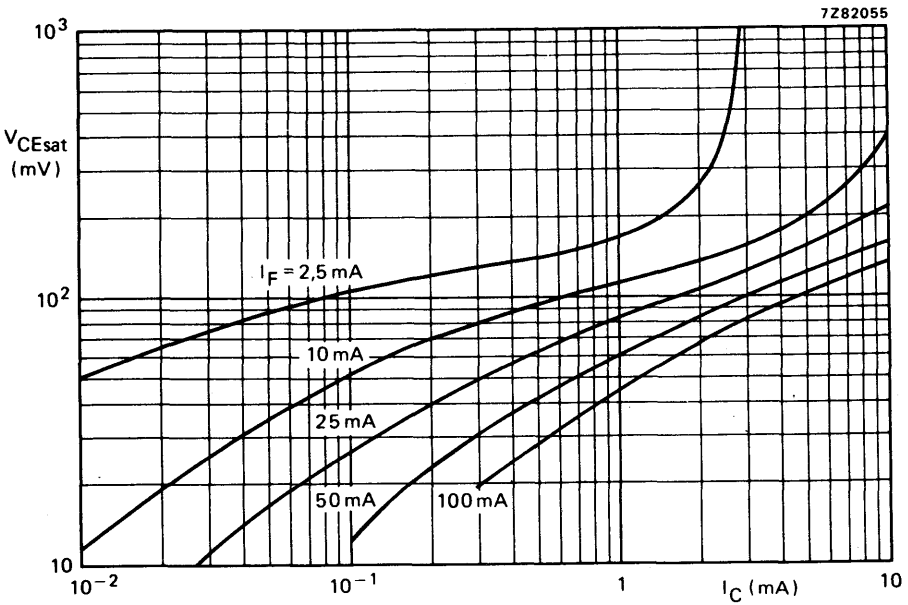

Fig. 18 CNY63;  $I_B = 0$ ;  $T_{amb} = 25^\circ C$ ; typical values.



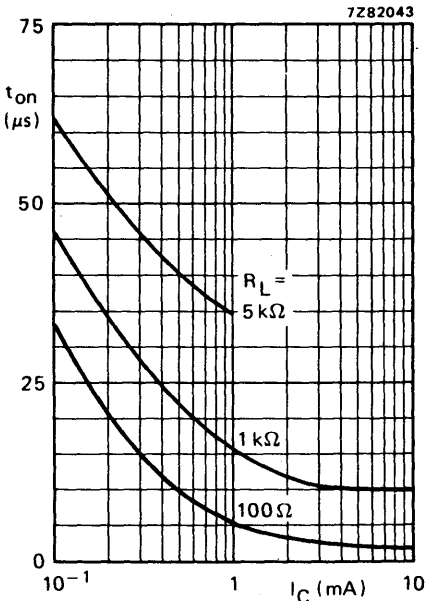

Fig. 19 CNY62;  $I_B = 0$ ;  $V_{CC} = 5\text{ V}$ ;  
 $T_{amb} = 25\text{ }^\circ\text{C}$ ; typical values.  
(See also Fig. 21.)

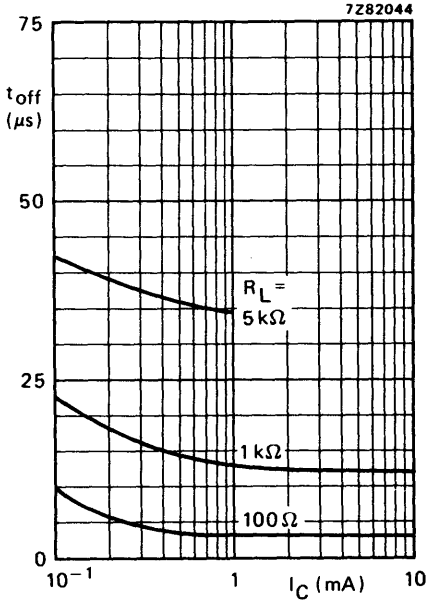

Fig. 20 CNY62;  $I_B = 0$ ;  $V_{CC} = 5\text{ V}$ ;  
 $T_{amb} = 25\text{ }^\circ\text{C}$ ; typical values.  
(See also Fig. 21.)

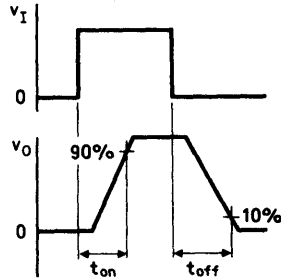
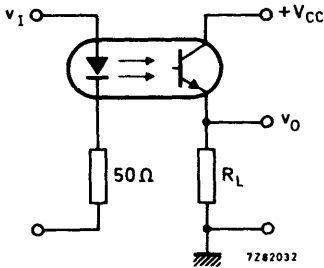

Fig. 21 Switching circuit and waveforms.



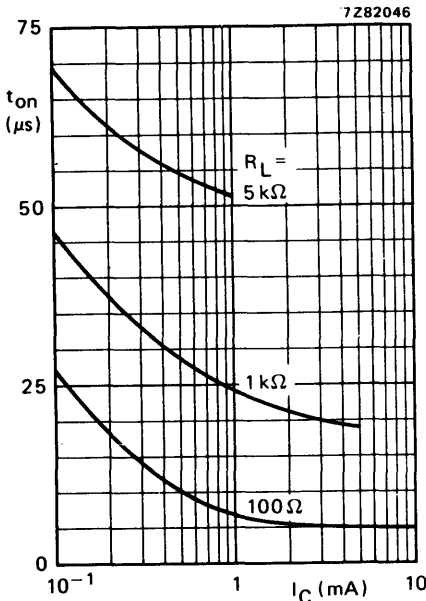

Fig. 22 CNY63;  $I_B = 0$ ;  $V_{CC} = 5 V$ ;  $T_{amb} = 25^\circ C$ ; typical values. (See also Fig. 24.)

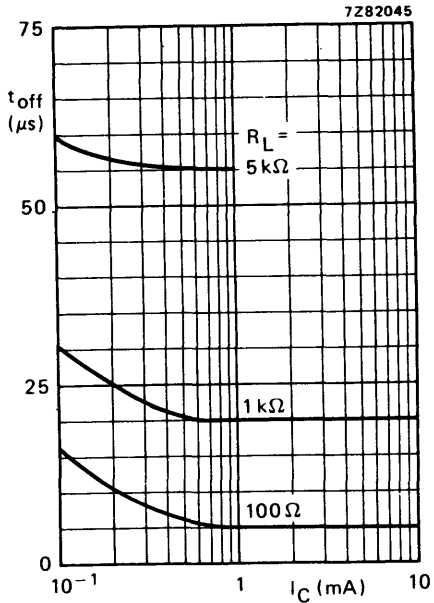

Fig. 23 CNY63;  $I_B = 0$ ;  $V_{CC} = 5 V$ ;  $T_{amb} = 25^\circ C$ ; typical values. (See also Fig. 24.)

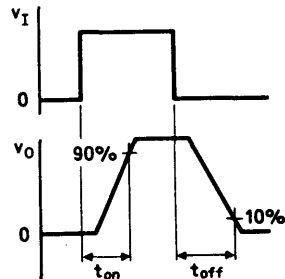
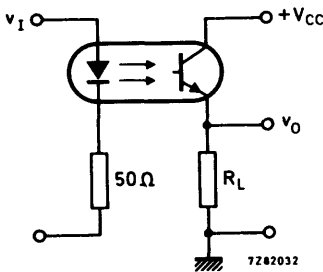

Fig. 24 Switching circuit and waveforms.





# LIQUID CRYSTAL DISPLAYS



# VIDELEC LIQUID CRYSTAL DISPLAYS

Type, overall dimensions and standard design

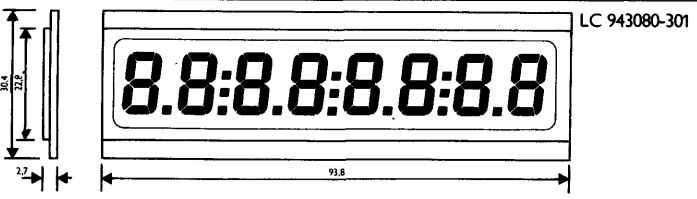
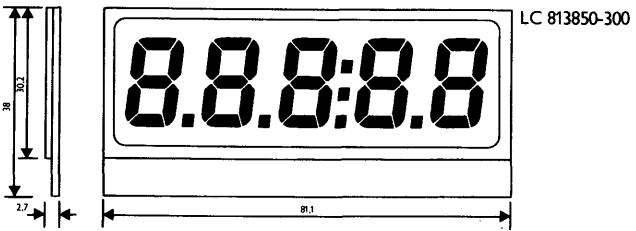
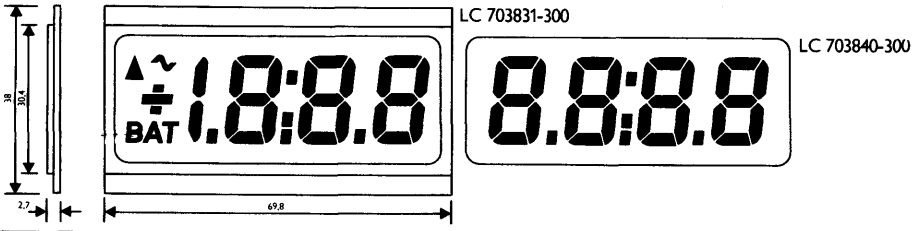
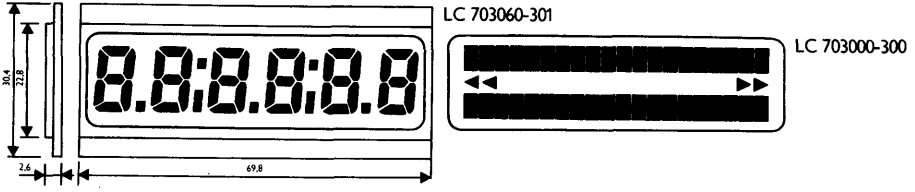
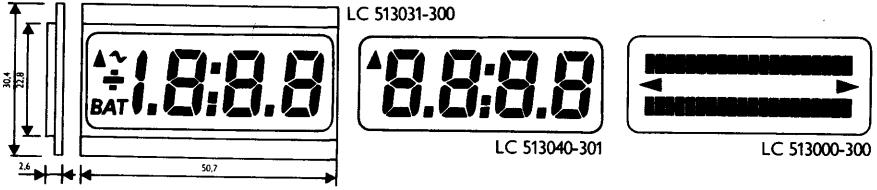
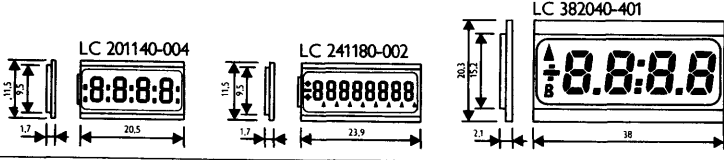

# VIDELEC LIQUID CRYSTAL DISPLAYS

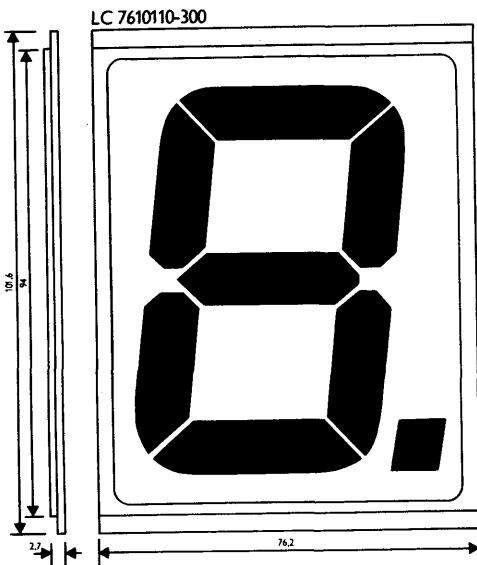

## Liquid-crystal displays for industry

- High-quality workmanship
- Low power consumption
- Low operating voltage
- Attractive standard designs
- Very high contrast
- 14 standardized glass sizes
- Service life > 50,000h
- Multiplex possible

## ELECTRO-OPTICAL DATA

	LC 2011 / LC 2411			other types from LC 3820			Units
	Typ.	Min.	Max.	Typ.	Min.	Max.	
Operating voltage	3	1.5	5	4.5	3	6	$V_{rms}$ eff
DC component			100			100	mV
Frequency	32	30	1000	32	30	100	Hz
Current consumption	11		22	15		40	nA/mm <sup>2</sup>
Rise time $\tau_{on}$	80			60			ms
Decay time $\tau_{off}$	200		250	50			ms
Cycle time $(\tau_{on} + \tau_{off})$	280			110		150	ms
Operating temperature range		-15	+60		-15	+60/+80	°C
Storage temperature range		-30	+60		-30	+60/+80	°C

Measured at  $T=25$  °C and with typical operating voltage

For further information and details of custom built devices, contact the Semiconductor Optoelectronics Group at

Mullard Limited, Mullard House, Torrington Place, London WC1E 7HD





## TYPE NUMBER INDEX

type number	section
BPW22A	B
BPW50	B
BPX25, 9	B
BPX95C	B
CNX21	H
CNX35, 6	H
CNX38	H
CNY50	H
CNY62, 3	H
CQW10 to 12	C
CQX10	C
CQX11	C
CQX12	C
CQX51	C
CQX54	C
CQX55 to 78	C
CQX64	C
CQX74	C
CQY11B	C
CQY11C	C
CQY24B	C
CQY49C	C
CQY50, 2	C
CQY54	C
CQY58A	C
CQY89A	C
CQY94	C
CQY95	C
CQY96	C
CQY97	C

type number	section
ORP13	D
ORP60	G
ORP61	G
ORP69	G
RPY31	D
RPY35	D
RPY51	D
RPY52	D
RPY58A	G
RPY86, 7	D
RPY88, 9	D
RPY90 series	D
RPY91 series	D
RPY93	D
RPY96	D
61SV	D
802CPY	E
825CPY	E





# OPTOELECTRONIC DEVICES

## CONTENTS

**GENERAL SAFETY RECOMMENDATIONS**

**A GENERAL**

**B PHOTODIODES AND PHOTOTRANSISTORS**

**C LIGHT EMITTING DIODES**

**D INFRARED DETECTORS**

**E CUSTOM BUILT TGS PYROELECTRIC  
INFRARED DETECTORS**

**F CUSTOM BUILT CMT INFRARED  
DETECTORS**

**G CADMIUM SULPHIDE PHOTOCONDUCTIVE  
CELLS**

**H PHOTOCOUPERS**

**J LIQUID CRYSTAL DISPLAYS**

**INDEX**

Mullard

Book 1 Part 9

Optoelectronic devices

Mullard Limited  
Mullard House, Torrington Place, London WC1E 7HD

May 1981



Printed in England  
M81-1252